



2019 BIKES

CATALOG



megamo



megamo



WE BUILD THE BIKE

YOU RIDE

DISCOVER OUR NEW MODELS



megamo



DESIGN / DISEÑO

All the design and development of our models is done in our Technical Department together with our competition team with a comprehensive methodology to meet the latest trends in the market.

Todo el diseño y desarrollo de nuestros modelos se realiza en nuestro Departamento Técnico conjuntamente con nuestro equipo de competición con una metodología exhaustiva para poder satisfacer las últimas tendencias del mercado.



PRODUCT AND FUNCTIONALITY PRODUCTO Y FUNCIONALIDAD

Our models are always developed with the maximum efficiency and functionality for the user. In this case, the opinion transmitted by our Partners is very important.

Nuestros modelos están desarrollados siempre pensando en la máxima eficiencia y funcionalidad para el usuario. En este caso, la opinión que nos transmiten nuestros Partners es muy importante.



SERVICE / SERVICIO

One of the most important premises today is the efficient delivery of the product to the Partners and having a regular stock to be able to satisfy the demand of the final customers.

Una de las premisas más importantes en la actualidad, es la entrega eficiente del producto a los Partners y contar con un stock regular para poder satisfacer la demanda de los clientes finales.





E-BIKES

6

FULL SUSPENSION

AYRON FORCE 05 ORANGE / GREEN.....	10-11
AYRON FORCE 10 ORANGE / GREEN.....	12-13
AYRON FORCE 20 ORANGE / GREEN.....	14-15
AYRON FORCE 30 ORANGE / GREEN.....	16-17
AYRON 10 ORANGE / GREEN.....	20-21
AYRON 20 ORANGE / GREEN.....	22-23
AYRON 30 ORANGE / GREEN.....	24-25

HARDTAIL

29 ASPE FORCE 10 ORANGE / GREEN.....	30-31
27,5 + ASPE FORCE 10 ORANGE / GREEN.....	32-33
29 ASPE FORCE 20 ORANGE / GREEN.....	34-35
27,5 + ASPE FORCE 20 ORANGE / GREEN.....	36-37
29 ASPE FORCE 30 ORANGE / GREEN.....	38-39
27,5 + ASPE FORCE 30 ORANGE / GREEN.....	40-41
XTREM.....	42-43

CITY - TREKKING

28 ROUTE GREY / WHITE.....	46-47
28 XPLORA.....	48-49
18 EXECUTIVE GREY / ORANGE / BLUE.....	52-54
28 TOP CITY GREY / WHITE.....	56-57
26 TOP CITY GREY / WHITE.....	58-59
20 CHIP 3.0.....	60-61

MTB

62

TRACK

TRACK ELITE ENVE EDITION ORANGE / GREEN / BLACK..	66-68
TRACK ELITE 01 ORANGE / GREEN / BLACK.....	69-71
TRACK ELITE 03 ORANGE / GREEN / BLACK.....	72-74
TRACK ELITE 05 ORANGE / GREEN / BLACK.....	75-77
TRACK 07 ORANGE / GREEN / BLACK.....	78-80
TRACK 10 ORANGE / GREEN / BLACK.....	81-83

FACTORY

FACTORY ELITE 03 EAGLE ORANGE / GREEN / BLACK..	88-90
FACTORY ELITE 05 EAGLE ORANGE / GREEN / BLACK....	91-93
FACTORY 07 EAGLE ORANGE / GREEN / BLACK.....	94-96
FACTORY 15 EAGLE ORANGE / GREEN / BLACK.....	97-99
FACTORY 20 ORANGE / GREEN / BLACK.....	100-102
FACTORY 30 EAGLE ORANGE / GREEN / BLACK.....	103-105
FACTORY 40 ORANGE / GREEN / BLACK.....	106-108

FULL SUSPENSION

XR 05 GREEN / ORANGE.....	112-113
XR 10 GREEN / ORANGE.....	114-115
XC 03.....	118-119

NATURAL

29 NATURAL ELITE 11 EAGLE GREEN / GREY.....	122-123
29 NATURAL ELITE 12 EAGLE GREEN / GREY.....	124-125
29 NATURAL ELITE 13 GREEN / GREY.....	126-127
29 NATURAL ELITE 17 GREEN / GREY.....	128-129
29 NATURAL RC 35 ORANGE / GREY.....	130-131
29 NATURAL RC 37 ORANGE / GREY.....	132-133
29 NATURAL RC 39 ORANGE / GREY.....	134-135
29/27,5 NATURAL 40 ORANGE / GREY.....	136-137
29/27,5 NATURAL 50 GREEN / YELLOW.....	138-139
29/27,5 NATURAL 60 ORANGE / GREEN / YELLOW.....	140-143

SPORT

29/27,5 DX3 BLACK / GREEN.....	144
27,5 FUN BLUE / GREEN.....	145
27,5 FUN LADY GREY / WHITE.....	146
26 KU2 YELLOW / BLACK.....	147
24 KU4.....	148
26 OPEN REPLICA ORANGE / GREY / BLUE / YELLOW.....	149-150
26 OPEN REPLICA LADY GREEN / BLUE / GREY / PINK.....	151-152
24 OPEN JUNIOR BOY ORANGE / YELLOW.....	153
24 OPEN JUNIOR GIRL WHITE / GREEN.....	154



ROAD

156

RACE SERIES

PULSE ELITE DISC 01 YELLOW / GREEN / GREY.....	160-162
PULSE ELITE DISC 03 YELLOW / GREEN / GREY.....	163-165
PULSE ELITE DISC 05 YELLOW / GREEN / GREY.....	166-168
PULSE ELITE DISC 10 YELLOW / GREEN / GREY.....	169-171
PULSE ELITE DISC 20 YELLOW / GREEN / GREY.....	172-175
PULSE ELITE 01 YELLOW / GREEN / GREY.....	178-180
PULSE ELITE 03 YELLOW / GREEN / GREY.....	181-183
PULSE ELITE 05 YELLOW / GREEN / GREY.....	184-186
PULSE ELITE 10 YELLOW / GREEN / GREY.....	187-189
PULSE ELITE 20 YELLOW / GREEN / GREY.....	190-193

LIGHTWEIGHT

RAISE 03 YELLOW / GREEN / GREY.....	196-198
RAISE 05 YELLOW / GREEN / GREY.....	199-201
RAISE 10 YELLOW / GREEN / GREY.....	202-204
RAISE 20 YELLOW / GREEN / GREY.....	205-207
CORE 03 YELLOW / GREEN / GREY.....	210-212
CORE 05 YELLOW / GREEN / GREY.....	213-215
CORE 10 YELLOW / GREEN / GREY.....	216-218
CORE 20 YELLOW / GREEN / GREY.....	219-221
CORE 30 YELLOW / GREEN / GREY.....	222-225

ENDURANCE

R10 105 ORANGE / GREY / GREEN.....	226-228
R10 TIAGRA ORANGE / GREY / GREEN.....	229-231

GRAVE

GRAVE 10 ORANGE / BLACK.....	234-235
GRAVE 20 ORANGE / BLACK.....	236-237

FAT

238

GREAT.....	240
TANK ORANGE / YELLOW.....	241-242
JUNGLE.....	243

TREKKING

244

ADVENTURE 10.....	246
ADVENTURE 20.....	247
28 TACAMA.....	248
26 KIBO.....	249

CITY

250

URBAN

AERO FIXIE.....	252
NONAME PRO ORANGE / BLACK.....	253
NONAME GREEN / COOPER / SILVER / BLUE.....	254-255
28 AMSTERDAM.....	256-257

CITY

28 TAMARIU GREEN / WHITE.....	258
28 TRIVIA DARK BLUE / BEIGE.....	259
26 TRIVIA COOPER / BLUE.....	260
24 TRIVIA.....	261
28 RONDA.....	262
26 RONDA WHITE / BLACK.....	263

FOLDING

24 MAXI.....	264
20 ZAMBRA GREY / WHITE.....	265

KIDS/BMX

266

KIDS

20 OPEN JUNIOR SUSP. BOY.....	268
20 OPEN JUNIOR SUSP. GIRL.....	269
20 OPEN JUNIOR BOY YELLOW / BLUE.....	270
20 OPEN JUNIOR GIRL BLUE / WHITE.....	271
18 KID BOY / GIRL.....	272
16 KID BOY / GIRL.....	273
14 KID BOY / GIRL.....	274-275

BMX

BLAZER GREEN / ORANGE.....	276-277
----------------------------	---------

WEAR/ROPA

278

MAILLOT ORANGE.....	280
CULOTTE ORANGE.....	281
MAILLOT GREEN.....	282
CULOTTE GREEN.....	283
ACCESSORIES.....	284





megamo

E-BIKES

FULL SUSPENSION

AYRON FORCE 05 ORANGE / GREEN.....	10-11
AYRON FORCE 10 ORANGE / GREEN.....	12-13
AYRON FORCE 20 ORANGE / GREEN.....	14-15
AYRON FORCE 30 ORANGE / GREEN.....	16-17
AYRON 10 ORANGE / GREEN.....	20-21
AYRON 20 ORANGE / GREEN.....	22-23
AYRON 30 ORANGE / GREEN.....	24-25

HARDTAIL

29 ASPE FORCE 10 ORANGE / GREEN.....	30-31
27,5 + ASPE FORCE 10 ORANGE / GREEN.....	32-33
29 ASPE FORCE 20 ORANGE / GREEN.....	34-35
27,5 + ASPE FORCE 20 ORANGE / GREEN.....	36-37
29 ASPE FORCE 30 ORANGE / GREEN.....	38-39
27,5 + ASPE FORCE 30 ORANGE / GREEN.....	40-41
XTREM.....	42-43

CITY - TREKKING

28 ROUTE GREY / WHITE.....	46-47
28 XPLORA.....	48-49
18 EXECUTIVE GREY / ORANGE / BLUE.....	52-54
28 TOP CITY GREY / WHITE.....	56-57
26 TOP CITY GREY / WHITE.....	58-59
20 CHIP 3.0.....	60-61

AYRON FORCE



Discover a new experience: the E-MTB. With electric pedal assistance motors and a compact frame with specific geometry with a very centered and low centre of gravity, you will be able to reach the same sites as before, but with extra power. With multiple modes of action on the motor you will be able to control the power transmitted to the pedalier axis through a display in the handlebar. The battery is in charge of the autonomy, lasting more than what can be expected. We benefit from the new E - 8000 engine developed by Shimano and the long-travel suspension that provides never-before-seen grip and traction: everything so you can enjoy the E-MTB experience.

Descubre una nueva experiencia: el E-MTB. Con los motores eléctricos de asistencia al pedaleo y un cuadro compacto de geometría específica con un centro de gravedad muy centrado y bajo, podrás llegar a los mismos sitios que ya conocías anteriormente, pero contando con un plus añadido en potencia. Con varios modos de acción sobre el motor podrás controlar la potencia transmitida al eje de pedalier a través de un display en el manillar. La batería se encarga de la autonomía, siendo ésta mucho más duradera de lo que se puede esperar. Nos beneficiamos del nuevo motor E - 8000 desarrollado por Shimano y de la suspensión de largo recorrido que proporciona un agarre y tracción nunca antes vistos: todo para que tu puedas disfrutar de la experiencia E-MTB.



DESIGN AND DEVELOPMENT

Battery is fully integrated in the diagonal tube. An easy and comfortable extraction, get a clean aesthetic and MTB bicycle line of light shapes. Its impermeability, ventilation and reliability have been the basis in the development.

DISEÑO Y DESARROLLO

La batería está totalmente integrada en el tubo diagonal. Una extracción fácil y cómoda, consigue una estética limpia y una línea de bicicleta MTB de formas ligeras. Su impermeabilidad, ventilación, fiabilidad han sido las bases en el desarrollo.

SUSPENSION SYSTEM

A pivot system that optimizes feelings while riding the bike.

Designed to go up and down, without pedalling contamination.

SISTEMA SUSPENSIÓN

Un sistema de pivotaje que optimiza sensaciones encima de la bici. Diseñada para subir y bajar, sin contaminación de pedalada existente.



DISPLAY

Extensive choice of power assisting settings to match your unique riding style. Compact, easy-to-read display with dynamic visual images when switching between support settings.

DISPLAY

Amplia selección de ajustes de asistencia al pedaleo para adaptarse a tu estilo de pedaleo único. Pantalla compacta y de fácil lectura con imágenes dinámicas al cambiar entre los ajustes de asistencia.

MOTOR

The Shimano engine allows us to get short pods, giving agility. Rigidity is assured with the Boost system.

MOTOR











El motor Shimano nos permite conseguir unas vainas cortas, dando agilidad. Rigidez asegurada con el sistema Boost.













AYRON FORCE 05 ORANGE



SPECIFICATIONS / ESPECIFICACIONES

-  FULL INTEGRATED BATTERY, ALLOY 6061 TRIPLE BUTTED I2xI48 BOOST, HORST LINK 4, WHEEL TRAVEL: 130 mm
-  FOX E-34 RHYTHM FLOAT, E-Bike+, TRAVEL 150, BOOST I5QRxI10
-  FOX PERFORMANCE FLOAT 200x57
-  FSA ORBIT 1,5 E ZS 1-1/8" 1,5"
-  ALLOY BUTTED 31,8x720 mm, RISE: 12 mm, BACK SWEEP: 6°
-  3D FORGED ALLOY, EXT.: 60-70-90 mm, RISE: ±7°
-  MEGAMO 30,9 mm TELESCOPIC SEAT POST, REMOTE ADJUSTMENT
-  MEGAMO
-  SRAM NX EAGLE 12s
-  SHIMANO E-8000
-  SRAM NX EAGLE 12s

-  SHIMANO MT501 HYDRAULIC DISC
-  BOOST SYSTEM 15x110 12x148
-  27.5+ BOOST SYSTEM 15x110 12x148 WIDE:40mm
-  MAXXIS IKON 27.5 x 2.8 ALL MOUNTAIN TIRES 27.5 PLUS
-  SRAM NX EAGLE 12s 11-50T
-  SHIMANO E8000 250W
-  INTEGRATED 500 Litió-Ion (Li-Ion) 36V - 13,8 Ah - 500 Wh
-  ECO: 125 Km, TRAIL: 100 Km, BOOST: 75 Km
-  4 HOURS
-  25 Km/h
-  SHIMANO E8000

* Posibilidad de incorporar porta bidón (no incluido)

* Possibility of incorporating bottle cage (not included)

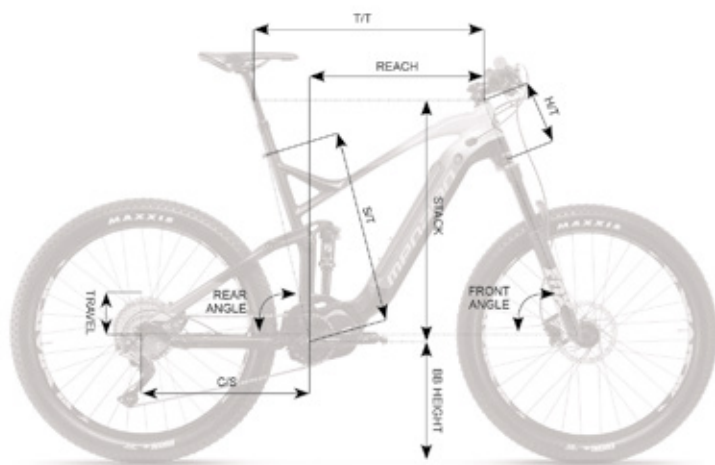























AYRON FORCE 05

	S	M	L
SIZE	15"	18"	20,5"
T/T	575	610	644
C/S	430	430	430
S/T	400	460	520
H/T	130	140	160
REACH	395	426	460
STACK	631	640	660
FRONT ANGLE	67	67	67
REAR ANGLE	74	73,5	73
L/T	200x57	200x57	200x57
TRAVEL	130	130	130

AYRON FORCE 05 GREEN



SPECIFICATIONS / ESPECIFICACIONES

-  FULL INTEGRATED BATTERY, ALLOY 6061 TRIPLE BUTTED 12x148 BOOST, HORST LINK 4, WHEEL TRAVEL: 130 mm
-  FOX E-34 RHYTHM FLOAT, E-Bike+, TRAVEL 150, BOOST I5QRx110
-  FOX PERFORMANCE FLOAT 200x57
-  FSA ORBIT 1,5 E ZS 1-1/8" 1,5"
-  ALLOY BUTTED 31,8x720 mm, RISE: 12 mm, BACK SWEEP: 6°
-  3D FORGED ALLOY, EXT.: 60-70-90 mm, RISE: ±7°
-  MEGAMO 30,9 mm TELESCOPIC SEAT POST, REMOTE ADJUSTMENT
-  MEGAMO
-  SRAM NX EAGLE 12s
-  SHIMANO E-8000
-  SRAM NX EAGLE 12s
-  SHIMANO MT501 HYDRAULIC DISC
-  BOOST SYSTEM 15x110 12x148
-  27.5+ BOOST SYSTEM 15x110 12x148 WIDE:40mm
-  MAXXIS IKON 27.5 x 2.8 ALL MOUNTAIN TIRES 27.5 PLUS
-  SRAM NX EAGLE 12s 11-50T
-  SHIMANO E8000 250W
-  INTEGRATED 500 Lito-Ion (Li-Ion) 36V - 13,8 Ah - 500 Wh
-  ECO: 125 Km, TRAIL: 100 Km, BOOST: 75 Km
-  4 HOURS
-  25 Km/h
-  SHIMANO E8000

* Posibilidad de incorporar porta bidón (no incluido)

* Possibility of incorporating bottle cage (not included)

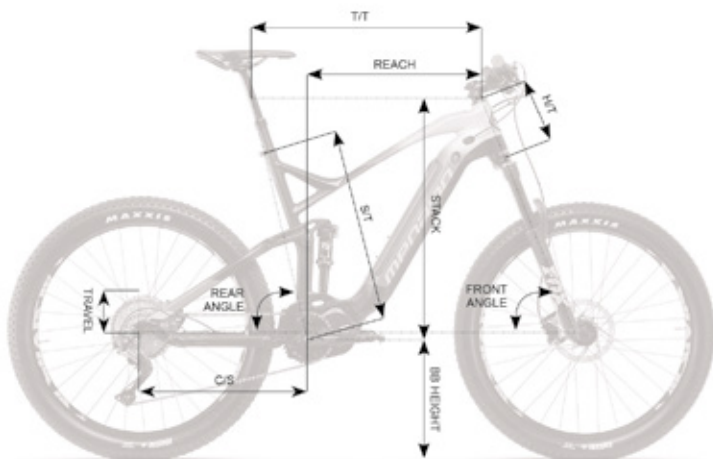























AYRON FORCE 05

	S	M	L
SIZE	15"	18"	20,5"
T/T	575	610	644
C/S	430	430	430
S/T	400	460	520
H/T	130	140	160
REACH	395	426	460
STACK	631	640	660
FRONT ANGLE	67	67	67
REAR ANGLE	74	73,5	73
L/T	200x57	200x57	200x57
TRAVEL	130	130	130

AYRON FORCE 10 ORANGE



SPECIFICATIONS / ESPECIFICACIONES

 FULL INTEGRATED BATTERY, ALLOY 6061 TRIPLE BUTTED 12x148 BOOST, HORST LINK 4, WHEEL TRAVEL: 130 mm	 SHIMANO MT501 HYDRAULIC DISC
 FOX E-34 RHYTHM FLOAT, E-Bike+, TRAVEL 150, BOOST I5QRx110	 BOOST SYSTEM 15x110 12x148
 FOX PERFORMANCE FLOAT 200x57	 27.5+ BOOST SYSTEM 15x110 12x148 WIDE:40mm
 FSA ORBIT 1,5 E ZS 1-1/8" 1,5"	 MAXXIS IKON 27.5 x 2.8 ALL MOUNTAIN TIRES 27.5 PLUS
 ALLOY BUTTED 31,8x720 mm, RISE: 12 mm, BACK SWEEP: 6°	 SHIMANO SLX 7000 11s
 3D FORGED ALLOY, EXT.: 60-70-90 mm, RISE: ±7°	 SHIMANO E8000 250W
 MEGAMO 30,9 mm TELESCOPIC SEAT POST, REMOTE ADJUSTMENT	 INTEGRATED 500 Litió-Ion (Li-Ion) 36V - 13,8 Ah - 500 Wh
 MEGAMO	 ECO: 125 Km, TRAIL: 100 Km, BOOST: 75 Km
 SHIMANO SLX 7000 11s	 4 HOURS
 SHIMANO E-8000	 25 Km/h
 SHIMANO SLX 7000 11s	 SHIMANO E8000

* Posibilidad de incorporar porta bidón (no incluido)

* Possibility of incorporating bottle cage (not included)

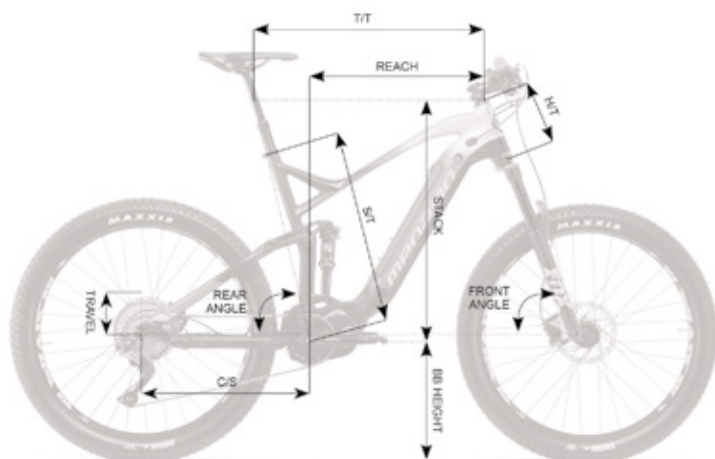























AYRON FORCE 10

	S	M	L
SIZE	15"	18"	20,5"
T/T	575	610	644
C/S	430	430	430
S/T	400	460	520
H/T	130	140	160
REACH	395	426	460
STACK	631	640	660
FRONT ANGLE	67	67	67
REAR ANGLE	74	73,5	73
L/T	200x57	200x57	200x57
TRAVEL	130	130	130

AYRON FORCE 10 GREEN



SPECIFICATIONS / ESPECIFICACIONES

 FULL INTEGRATED BATTERY, ALLOY 6061 TRIPLE BUTTED 12x148 BOOST, HORST LINK 4, WHEEL TRAVEL: 130 mm	 SHIMANO MT501 HYDRAULIC DISC
 FOX E-34 RHYTHM FLOAT, E-Bike+, TRAVEL 150, BOOST I5QRx110	 BOOST SYSTEM 15x110 12x148
 FOX PERFORMANCE FLOAT 200x57	 27.5+ BOOST SYSTEM 15x110 12x148 WIDE:40mm
 FSA ORBIT 1,5 E ZS 1-1/8" 1,5"	 MAXXIS IKON 27.5 x 2.8 ALL MOUNTAIN TIRES 27.5 PLUS
 ALLOY BUTTED 31,8x720 mm, RISE: 12 mm, BACK SWEEP: 6°	 SHIMANO SLX 7000 11s
 3D FORGED ALLOY, EXT.: 60-70-90 mm, RISE: ±7°	 SHIMANO E8000 250W
 MEGAMO 30,9 mm TELESCOPIC SEAT POST, REMOTE ADJUSTMENT	 INTEGRATED 500 Lito-Ion (Li-Ion) 36V - 13,8 Ah - 500 Wh
 MEGAMO	 ECO: 125 Km, TRAIL: 100 Km, BOOST: 75 Km
 SHIMANO SLX 7000 11s	 4 HOURS
 SHIMANO E-8000	 25 Km/h
 SHIMANO SLX 7000 11s	 SHIMANO E8000

* Posibilidad de incorporar porta bidón (no incluido)

* Possibility of incorporating bottle cage (not included)

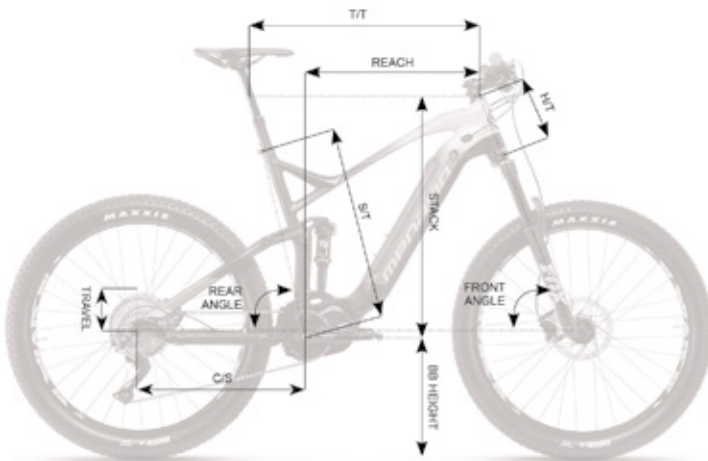























AYRON FORCE 10

	S	M	L
SIZE	15"	18"	20,5"
T/T	575	610	644
C/S	430	430	430
S/T	400	460	520
H/T	130	140	160
REACH	395	426	460
STACK	631	640	660
FRONT ANGLE	67	67	67
REAR ANGLE	74	73,5	73
L/T	200x57	200x57	200x57
TRAVEL	130	130	130

AYRON FORCE 20 ORANGE



SPECIFICATIONS / ESPECIFICACIONES

 FULL INTEGRATED BATTERY, ALLOY 6061 TRIPLE BUTTED 12x148 BOOST, HORST LINK 4, WHEEL TRAVEL: 130 mm	 SHIMANO M201 HYDRAULIC DISC
 ROCK SHOX RECON RL AIR, E-BIKE+ TRAVEL 140mm, BOOST 15x110	 BOOST SYSTEM 15x110 12x148
 ROCK SHOX MONARCH RL 200 x 57 Lockout	 27.5+ BOOST SYSTEM 15x110 12x148 WIDE:40mm
 FSA ORBIT 1,5 E ZS 1-1/8" 1,5"	 MAXXIS IKON 27.5 x 2.8 ALL MOUNTAIN TIRES 27.5 PLUS
 ALLOY BUTTED 31,8x720 mm, RISE: 12 mm, BACK SWEEP: 6°	 SHIMANO DEORE 6000 11-42T 10s
 3D FORGED ALLOY, EXT.: 60-70-90 mm, RISE: ±7°	 SHIMANO E8000 250W
 MEGAMO 30,9 mm TELESCOPIC SEAT POST, REMOTE ADJUSTMENT	 INTEGRATED 500 Litió-Ion (Li-Ion) 36V - 13,8 Ah - 500 Wh
 MEGAMO	 ECO: 125 Km, TRAIL: 100 Km, BOOST: 75 Km
 SHIMANO DEORE 6000 10s	 4 HOURS
 SHIMANO E-8000	 25 Km/h
 SHIMANO DEORE 6000 10s	 SHIMANO E8000

* Posibilidad de incorporar porta bidón (no incluido)
 * Possibility of incorporating bottle cage (not included)

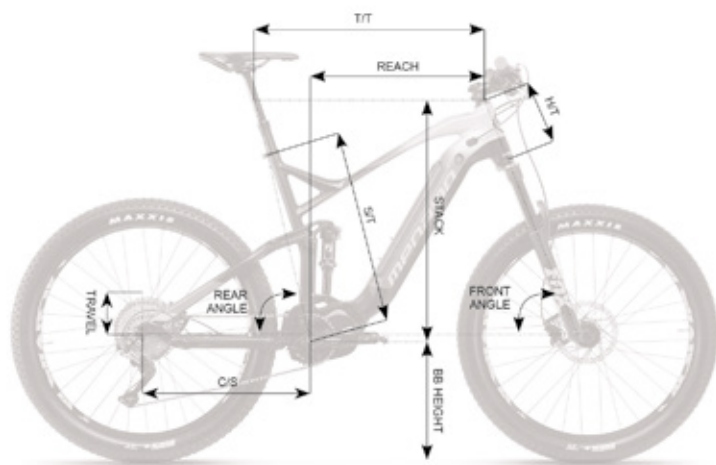











AYRON FORCE 20









	S	M	L
SIZE	15"	18"	20,5"
T/T	575	610	644
C/S	430	430	430
S/T	400	460	520
H/T	130	140	160
REACH	395	426	460
STACK	631	640	660
FRONT ANGLE	67	67	67
REAR ANGLE	74	73,5	73
L/T	200x57	200x57	200x57
TRAVEL	130	130	130

AYRON FORCE 20 GREEN



SPECIFICATIONS / ESPECIFICACIONES

-  FULL INTEGRATED BATTERY, ALLOY 6061 TRIPLE BUTTED 12x148 BOOST, HORST LINK 4, WHEEL TRAVEL: 130 mm
-  ROCK SHOX RECON RL AIR, E-BIKE+ TRAVEL 140mm, BOOST 15x110
-  ROCK SHOX MONARCH RL 200 x 57 Lockout
-  FSA ORBIT 1,5 E ZS 1-1/8" 1,5"
-  ALLOY BUTTED 31,8x720 mm, RISE: 12 mm, BACK SWEEP: 6°
-  3D FORGED ALLOY, EXT.: 60-70-90 mm, RISE: ±7°
-  MEGAMO 30,9 mm TELESCOPIC SEAT POST, REMOTE ADJUSTMENT
-  MEGAMO
-  SHIMANO DEORE 6000 10s
-  SHIMANO E-8000
-  SHIMANO DEORE 6000 10s

-  SHIMANO M201 HYDRAULIC DISC
-  BOOST SYSTEM 15x110 12x148
-  27.5+ BOOST SYSTEM 15x110 12x148 WIDE:40mm
-  MAXXIS IKON 27.5 x 2.8 ALL MOUNTAIN TIRES 27.5 PLUS
-  SHIMANO DEORE 6000 11-42T 10s
-  SHIMANO E8000 250W
-  INTEGRATED 500 Lito-Ion (Li-Ion) 36V - 13,8 Ah - 500 Wh
-  ECO: 125 Km, TRAIL: 100 Km, BOOST: 75 Km
-  4 HOURS
-  25 Km/h
-  SHIMANO E8000

* Posibilidad de incorporar porta bidón (no incluido)

* Possibility of incorporating bottle cage (not included)

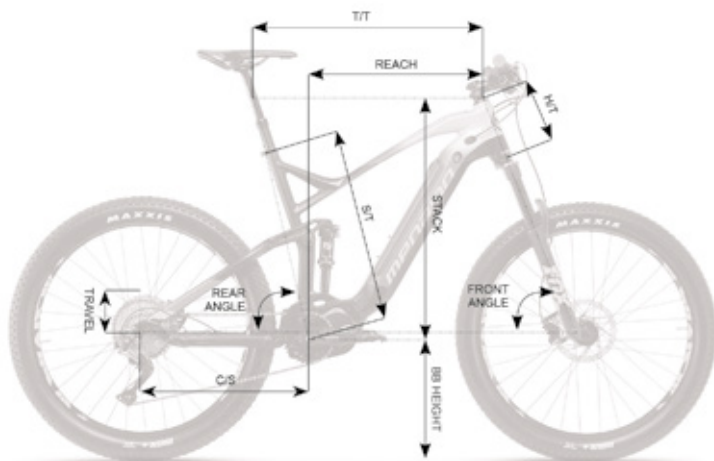

AYRON FORCE 20

	S	M	L
SIZE	15"	18"	20,5"
T/T	575	610	644
C/S	430	430	430
S/T	400	460	520
H/T	130	140	160
REACH	395	426	460
STACK	631	640	660
FRONT ANGLE	67	67	67
REAR ANGLE	74	73,5	73
L/T	200x57	200x57	200x57
TRAVEL	130	130	130

AYRON FORCE 30 ORANGE



SPECIFICATIONS / ESPECIFICACIONES

 FULL INTEGRATED BATTERY, ALLOY 6061 TRIPLE BUTTED 12x148 BOOST, HORST LINK 4, WHEEL TRAVEL: 130 mm	 SHIMANO M201 HYDRAULIC DISC
 SUNTOUR XCR 34 AIR, E-BIKE+, TRAVEL 130mm, BOOST 15x110, MINI-FENDER INCLUDED	 BOOST SYSTEM 15x110 12x148
 SUNTOUR RAIDON 200x57 COMP. REGUL.	 27.5+ BOOST SYSTEM 15x110 12x148 WIDE:40mm
 FSA ORBIT 1,5 E ZS 1-1/8" 1,5"	 WTB RANGER 27,5x2,8 ALL MOUNTAIN 27.5 PLUS
 ALLOY BUTTED 31,8x720 mm, RISE: 12 mm, BACK SWEEP: 6°	 SHIMANO DEORE 6000 11-42T 10s
 3D FORGED ALLOY, EXT.: 60-70-90 mm, RISE: ±7°	 SHIMANO E8000 250W
 MEGAMO 30,9 mm	 INTEGRATED 500 Litio-Ion (Li-Ion) 36V - 13,8 Ah - 500 Wh
 MEGAMO	 ECO: 125 Km, TRAIL: 100 Km, BOOST: 75 Km
 SHIMANO DEORE 6000 10s	 4 HOURS
 SHIMANO E-8000	 25 Km/h
 SHIMANO DEORE 6000 10s	 SHIMANO E8000

* Posibilidad de incorporar porta bidón (no incluido)

* Possibility of incorporating bottle cage (not included)

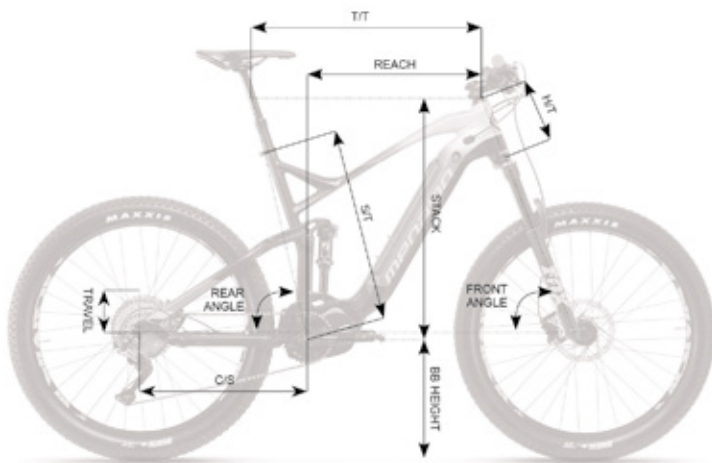

AYRON FORCE 30

	S	M	L
SIZE	15"	18"	20,5"
T/T	575	610	644
C/S	430	430	430
S/T	400	460	520
H/T	130	140	160
REACH	395	426	460
STACK	631	640	660
FRONT ANGLE	67	67	67
REAR ANGLE	74	73,5	73
L/T	200x57	200x57	200x57
TRAVEL	130	130	130

AYRON FORCE 30 GREEN



SPECIFICATIONS / ESPECIFICACIONES

-  FULL INTEGRATED BATTERY, ALLOY 6061 TRIPLE BUTTED 12x148 BOOST, HORST LINK 4, WHEEL TRAVEL: 130 mm
-  SUNTOUR XCR 34 AIR, E-BIKE+, TRAVEL 130mm, BOOST 15x110, MINI-FENDER INCLUDED
-  SUNTOUR RAIDON 200x57 COMP. REGUL.
-  FSA ORBIT 1,5 E ZS 1-1/8" 1,5"
-  ALLOY BUTTED 31,8x720 mm, RISE: 12 mm, BACK SWEEP: 6°
-  3D FORGED ALLOY, EXT.: 60-70-90 mm, RISE: ±7°
-  MEGAMO 30,9 mm
-  MEGAMO
-  SHIMANO DEORE 6000 10s
-  SHIMANO E-8000
-  SHIMANO DEORE 6000 10s
-  SHIMANO M201 HYDRAULIC DISC
-  BOOST SYSTEM 15x110 12x148
-  27.5+ BOOST SYSTEM 15x110 12x148 WIDE:40mm
-  WTB RANGER 27,5x2,8 ALL MOUNTAIN 27.5 PLUS
-  SHIMANO DEORE 6000 11-42T 10s
-  SHIMANO E8000 250W
-  INTEGRATED 500 Lito-Ion (Li-Ion) 36V - 13,8 Ah - 500 Wh
-  ECO: 125 Km, TRAIL: 100 Km, BOOST: 75 Km
-  4 HOURS
-  25 Km/h
-  SHIMANO E8000

* Posibilidad de incorporar porta bidón (no incluido)

* Possibility of incorporating bottle cage (not included)

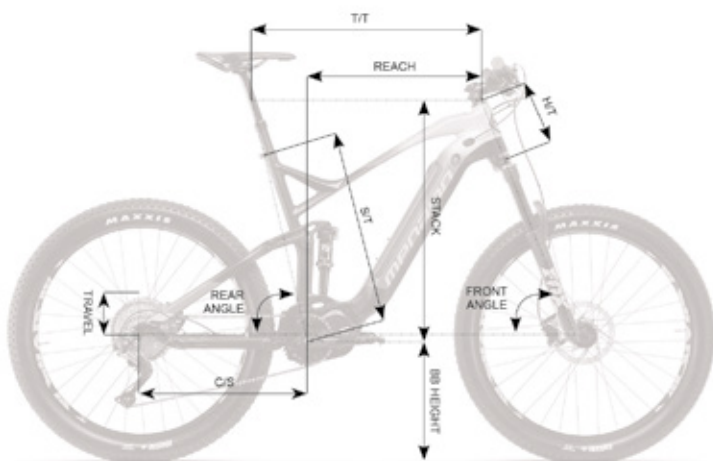

AYRON FORCE 30

	S	M	L
SIZE	15"	18"	20,5"
T/T	575	610	644
C/S	430	430	430
S/T	400	460	520
H/T	130	140	160
REACH	395	426	460
STACK	631	640	660
FRONT ANGLE	67	67	67
REAR ANGLE	74	73,5	73
L/T	200x57	200x57	200x57
TRAVEL	130	130	130

AYRON



Discover a new experience: the E-MTB. With electric pedal assistance motors and a compact frame with specific geometry with a very centered and low centre of gravity, you will be able to reach the same sites as before, but with extra power. With multiple modes of action on the motor you will be able to control the power transmitted to the pedalier axis through a display in the handlebar. The battery is in charge of the autonomy, lasting more than what can be expected. We benefit from the new E - 8000 engine developed by Shimano and the long-travel suspension that provides never-before-seen grip and traction: everything so you can enjoy the E-MTB experience.

Descubre una nueva experiencia: el E-MTB. Con los motores eléctricos de asistencia al pedaleo y un cuadro compacto de geometría específica con un centro de gravedad muy centrado y bajo, podrás llegar a los mismos sitios que ya conocías anteriormente, pero contando con un plus añadido en potencia. Con varios modos de acción sobre el motor podrás controlar la potencia transmitida al eje de pedalier a través de un display en el manillar. La batería se encarga de la autonomía, siendo ésta mucho más duradera de lo que se puede esperar. Nos beneficiamos del nuevo motor E - 8000 desarrollado por Shimano y de la suspensión de largo recorrido que proporciona un agarre y tracción nunca antes vistos: todo para que tu puedas disfrutar de la experiencia E-MTB.



DESIGN AND DEVELOPMENT

Ayron represents e-MTB technology. Specifically created to have the best experience in handling and transmitting optimum power, from biker to land.

DISEÑO Y DESARROLLO

Ayron representa la tecnología e-MTB. Específicamente creada para tener la mejor experiencia en el manejo y la transmisión de potencia óptima, del biker al terreno.

SUSPENSION SYSTEM

A pivot system that optimizes feelings while riding the bike.

Designed to go up and down, without pedalling contamination.

SISTEMA SUSPENSIÓN

Un sistema de pivotaje que optimiza sensaciones encima de la bici. Diseñada para subir y bajar, sin contaminación de pedalada existente.



DISPLAY

Extensive choice of power assisting settings to match your unique riding style. Compact, easy-to-read display with dynamic visual images when switching between support settings.

DISPLAY

Amplia selección de ajustes de asistencia al pedaleo para adaptarse a tu estilo de pedaleo único. Pantalla compacta y de fácil lectura con imágenes dinámicas al cambiar entre los ajustes de asistencia.

MOTOR

The Shimano engine allows us to get short pods, giving agility. Rigidity is assured with the Boost system.

MOTOR























El motor Shimano nos permite conseguir unas vainas cortas, dando agilidad. Rigidez asegurada con el sistema Boost.



AYRON 10 ORANGE



SPECIFICATIONS / ESPECIFICACIONES

 ALLOY 6061 TRIPLE BUTTED 12x148 BOOST, INTERNAL CABLE ROUTING HORST LINK 4, WHEEL TRAVEL: 130 mm	 SHIMANO MT501 HYDRAULIC DISC
 FOX E-34 RHYTHM FLOAT, E-Bike+, TRAVEL 150, BOOST I5QRx110	 BOOST SYSTEM 15x110 12x148
 FOX PERFORMANCE FLOAT 200x57	 27.5+ BOOST SYSTEM 15x110 12x148 WIDE:40mm
 FSA ORBIT 1,5 E ZS 1-1/8" 1,5"	 MAXXIS IKON 27.5 x 2.8 ALL MOUNTAIN TIRES 27.5 PLUS
 ALLOY BUTTED 31,8x720 mm, RISE: 12 mm, BACK SWEEP: 6°	 SHIMANO SLX 7000 11s
 3D FORGED ALLOY, EXT.: 60-70-90 mm, RISE: ±7°	 SHIMANO E8000 250W
 MEGAMO 30,9 mm TELESCOPIC SEAT POST, REMOTE ADJUSTMENT	 SHIMANO 500 Lito-Ion (Li-Ion) 36V - 13,8 Ah - 500 Wh
 MEGAMO	 ECO: 125 Km, TRAIL: 100 Km, BOOST: 75 Km
 SHIMANO SLX 7000 11s	 4 HOURS
 SHIMANO E-8000	 25 Km/h
 SHIMANO SLX 7000 11s	 SHIMANO E8000

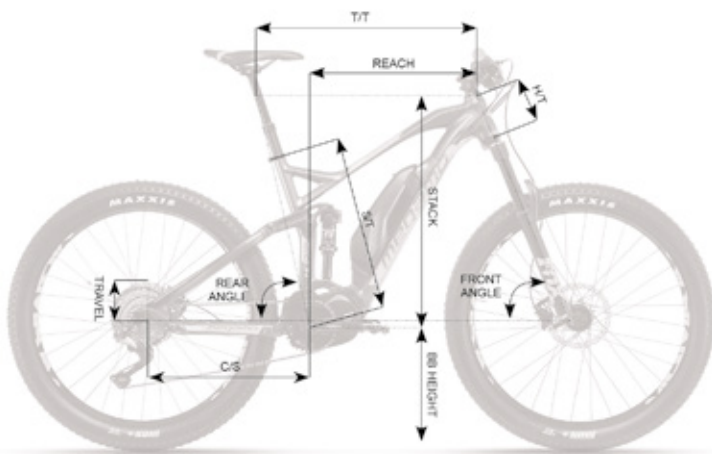























AYRON 10

	S	M	L
SIZE	16"	18"	20,5"
T/T	575	598	643
C/S	450	450	450
S/T	406	460	520
H/T	110	120	140
REACH	400	420	460
STACK	613	623	640
FRONT ANGLE	67	67	67
REAR ANGLE	74	74	74
L/T	200x57	200x57	200x57
TRAVEL	130	130	130

AYRON 10 GREEN



SPECIFICATIONS / ESPECIFICACIONES

 ALLOY 6061 TRIPLE BUTTED 12x148 BOOST, INTERNAL CABLE ROUTING HORST LINK 4, WHEEL TRAVEL: 130 mm	 SHIMANO MT501 HYDRAULIC DISC
 FOX E-34 RHYTHM FLOAT, E-Bike+, TRAVEL 150, BOOST I5QRx110	 BOOST SYSTEM 15x110 12x148
 FOX PERFORMANCE FLOAT 200x57	 27.5+ BOOST SYSTEM 15x110 12x148 WIDE:40mm
 FSA ORBIT 1,5 E ZS 1-1/8" 1,5"	 MAXXIS IKON 27.5 x 2.8 ALL MOUNTAIN TIRES 27.5 PLUS
 ALLOY BUTTED 31,8x720 mm, RISE: 12 mm, BACK SWEEP: 6°	 SHIMANO SLX 7000 11s
 3D FORGED ALLOY, EXT.: 60-70-90 mm, RISE: ±7°	 SHIMANO E8000 250W
 MEGAMO 30,9 mm TELESCOPIC SEAT POST, REMOTE ADJUSTMENT	 SHIMANO 500 Litio-Ion (Li-Ion) 36V - 13,8 Ah - 500 Wh
 MEGAMO	 ECO: 125 Km, TRAIL: 100 Km, BOOST: 75 Km
 SHIMANO SLX 7000 11s	 4 HOURS
 SHIMANO E-8000	 25 Km/h
 SHIMANO SLX 7000 11s	 SHIMANO E8000

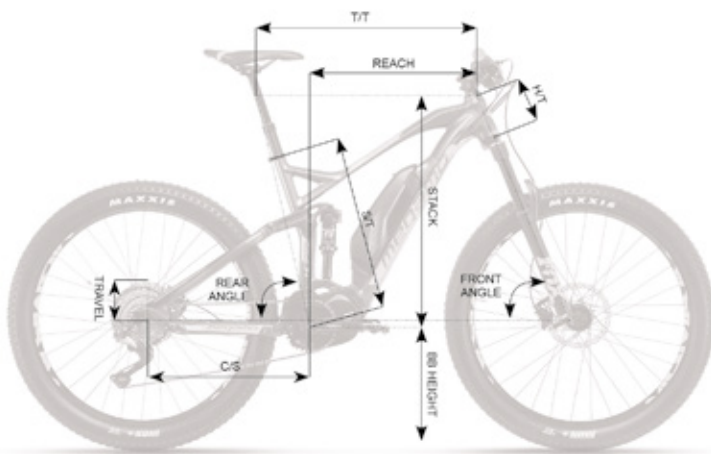























AYRON 10

	S	M	L
SIZE	16"	18"	20,5"
T/T	575	598	643
C/S	450	450	450
S/T	406	460	520
H/T	110	120	140
REACH	400	420	460
STACK	613	623	640
FRONT ANGLE	67	67	67
REAR ANGLE	74	74	74
L/T	200x57	200x57	200x57
TRAVEL	130	130	130

AYRON 20 ORANGE



SPECIFICATIONS / ESPECIFICACIONES

 ALLOY 6061 TRIPLE BUTTED 12x148 BOOST, INTERNAL CABLE ROUTING HORST LINK 4, WHEEL TRAVEL: 130 mm	 SHIMANO MT201 HYDRAULIC DISC
 ROCK SHOX JUDY AIR, TRAVEL 120mm, 15x110 BOOST + REMOTE LOCKOUT	 BOOST SYSTEM 15x110 12x148
 ROCK SHOX MONARCH RL 200 x 57 Lockout	 27.5+ BOOST SYSTEM 15x110 12x148 WIDE:40mm
 FSA ORBIT 1,5 E ZS 1-1/8" 1,5"	 MAXXIS IKON 27.5 x 2.8 ALL MOUNTAIN TIRES 27.5 PLUS
 ALLOY BUTTED 31,8x720 mm, RISE: 12 mm, BACK SWEEP: 6°	 SHIMANO DEORE 6000 11-42T 10s
 3D FORGED ALLOY, EXT.: 60-70-90 mm, RISE: ±7°	 SHIMANO E8000 250W
 MEGAMO 30,9 mm TELESCOPIC SEAT POST, REMOTE ADJUSTMENT	 SHIMANO 500 Latio-Ion (Li-Ion) 36V - 13,8 Ah - 500 Wh
 MEGAMO	 ECO: 125 Km, TRAIL: 100 Km, BOOST: 75 Km
 SHIMANO E-8000	 4 HOURS
 SHIMANO E-8000	 25 Km/h
 SHIMANO DEORE 6000 10s	 SHIMANO E8000

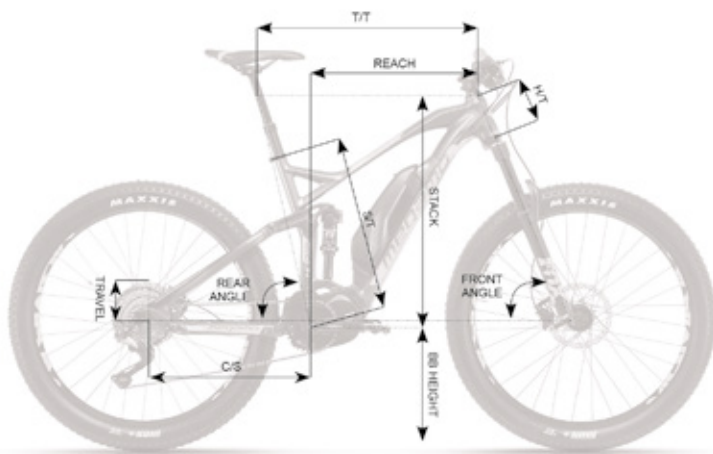























AYRON 20

	S	M	L
SIZE	16"	18"	20,5"
T/T	575	598	643
C/S	450	450	450
S/T	406	460	520
H/T	110	120	140
REACH	400	420	460
STACK	613	622	640
FRONT ANGLE	67	67	67
REAR ANGLE	74	74	74
L/T	200x57	200x57	200x57
TRAVEL	130	130	130

AYRON 20 GREEN



SPECIFICATIONS / ESPECIFICACIONES

-  ALLOY 6061 TRIPLE BUTTED 12x148 BOOST, INTERNAL CABLE ROUTING HORST LINK 4, WHEEL TRAVEL: 130 mm
-  ROCK SHOX JUDY AIR, TRAVEL 120mm, 15x110 BOOST + REMOTE LOCKOUT
-  ROCK SHOX MONARCH RL 200 x 57 Lockout
-  FSA ORBIT 1,5 E ZS 1-1/8" 1,5"
-  ALLOY BUTTED 31,8x720 mm, RISE: 12 mm, BACK SWEEP: 6°
-  3D FORGED ALLOY, EXT.: 60-70-90 mm, RISE: ±7°
-  MEGAMO 30,9 mm TELESCOPIC SEAT POST, REMOTE ADJUSTMENT
-  MEGAMO
-  SHIMANO E-8000
-  SHIMANO E-8000
-  SHIMANO DEORE 6000 10s
-  SHIMANO MT201 HYDRAULIC DISC
-  BOOST SYSTEM 15x110 12x148
-  27.5+ BOOST SYSTEM 15x110 12x148 WIDE:40mm
-  MAXXIS IKON 27.5 x 2.8 ALL MOUNTAIN TIRES 27.5 PLUS
-  SHIMANO DEORE 6000 11-42T 10s
-  SHIMANO E8000 250W
-  SHIMANO 500 Litió-Ion (Li-Ion) 36V - 13,8 Ah - 500 Wh
-  ECO: 125 Km, TRAIL: 100 Km, BOOST: 75 Km
-  4 HOURS
-  25 Km/h
-  SHIMANO E8000

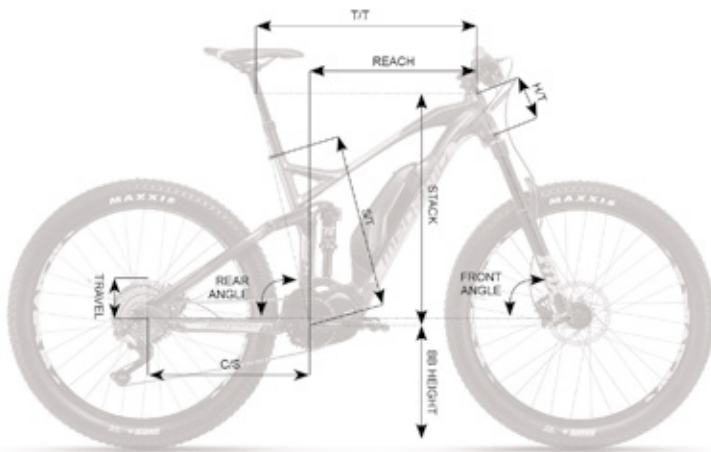























AYRON 20

	S	M	L
SIZE	16"	18"	20,5"
T/T	575	598	643
C/S	450	450	450
S/T	406	460	520
H/T	110	120	140
REACH	400	420	460
STACK	613	622	640
FRONT ANGLE	67	67	67
REAR ANGLE	74	74	74
L/T	200x57	200x57	200x57
TRAVEL	130	130	130

AYRON 30 ORANGE



SPECIFICATIONS / ESPECIFICACIONES

 ALLOY 6061 TRIPLE BUTTED 12x148 BOOST, INTERNAL CABLE ROUTING HORST LINK 4, WHEEL TRAVEL: 130 mm	 SHIMANO MT201 HYDRAULIC DISC
 SUNTOUR XCR 34 AIR, E-BIKE+, TRAVEL 130mm, BOOST 15x110, MINI-FENDER INCLUDED	 BOOST SYSTEM 15x110 12x148
 SUNTOUR RAIDON 200x57 COMP. REGUL.	 27.5+ BOOST SYSTEM 15x110 12x148 WIDE:40mm
 FSA ORBIT 1,5 E ZS 1-1/8" 1,5"	 WTB RANGER 27,5x2,8 ALL MOUNTAIN 27.5 PLUS
 ALLOY BUTTED 31,8x720 mm, RISE: 12 mm, BACK SWEEP: 6°	 SHIMANO DEORE 6000 11-42T 10s
 3D FORGED ALLOY, EXT.: 60-70-90 mm, RISE: ±7°	 SHIMANO E8000 250W
 MEGAMO 30,9 mm	 SHIMANO 500 Litió-Ion (Li-Ion) 36V - 13,8 Ah - 500 Wh
 MEGAMO	 ECO: 125 Km, TRAIL: 100 Km, BOOST: 75 Km
 SHIMANO DEORE 6000 10s	 4 HOURS
 SHIMANO E-8000	 25 Km/h
 SHIMANO DEORE 6000 10s	 SHIMANO E8000

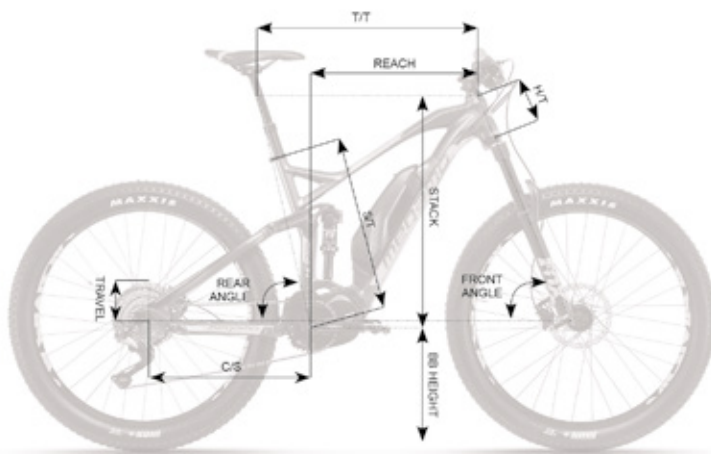











AYRON 30





	S	M	L
SIZE	16"	18"	20,5"
T/T	575	598	643
C/S	450	450	450
S/T	406	460	520
H/T	110	120	140
REACH	400	420	460
STACK	613	622	640
FRONT ANGLE	67	67	67
REAR ANGLE	74	74	74
L/T	200x57	200x57	200x57
TRAVEL	130	130	130

AYRON 30 GREEN



SPECIFICATIONS / ESPECIFICACIONES

-  ALLOY 6061 TRIPLE BUTTED 12x148 BOOST, INTERNAL CABLE ROUTING HORST LINK 4, WHEEL TRAVEL: 130 mm
-  SUNTOUR XCR 34 AIR, E-BIKE+, TRAVEL 130mm, BOOST 15x110, MINI-FENDER INCLUDED
-  SUNTOUR RAIDON 200x57 COMP. REGUL.
-  FSA ORBIT 1,5 E ZS 1-1/8" 1,5"
-  ALLOY BUTTED 31,8x720 mm, RISE: 12 mm, BACK SWEEP: 6°
-  3D FORGED ALLOY, EXT.: 60-70-90 mm, RISE: ±7°
-  MEGAMO 30,9 mm
-  MEGAMO
-  SHIMANO DEORE 6000 10s
-  SHIMANO E-8000
-  SHIMANO DEORE 6000 10s

-  SHIMANO MT201 HYDRAULIC DISC
-  BOOST SYSTEM 15x110 12x148
-  27.5+ BOOST SYSTEM 15x110 12x148 WIDE:40mm
-  WTB RANGER 27,5x2,8 ALL MOUNTAIN 27.5 PLUS
-  SHIMANO DEORE 6000 11-42T 10s
-  SHIMANO E8000 250W
-  SHIMANO 500 Litio-Ion (Li-Ion) 36V - 13,8 Ah - 500 Wh
-  ECO: 125 Km, TRAIL: 100 Km, BOOST: 75 Km
-  4 HOURS
-  25 Km/h
-  SHIMANO E8000

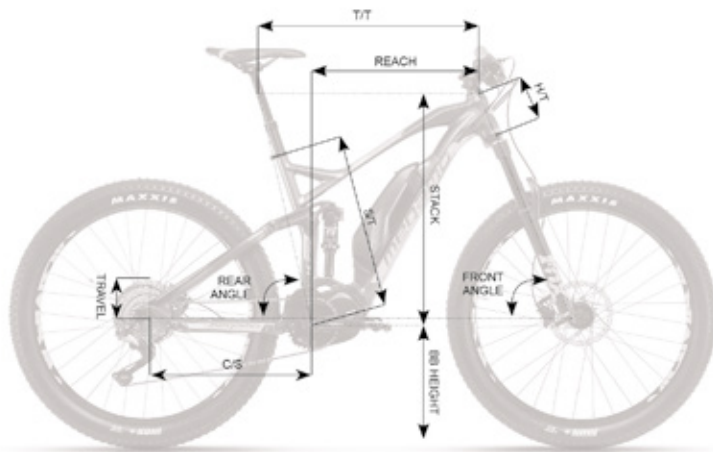

AYRON 30

	S	M	L
SIZE	16"	18"	20,5"
T/T	575	598	643
C/S	450	450	450
S/T	406	460	520
H/T	110	120	140
REACH	400	420	460
STACK	613	622	640
FRONT ANGLE	67	67	67
REAR ANGLE	74	74	74
L/T	200x57	200x57	200x57
TRAVEL	130	130	130





WEAR/ROPA

KIDS BMX

CITY

TREKKING

FAT

ROAD

MTB

E-BIKES

ASPE FORCE



Discover a new experience: the E-MTB. With electric pedal assistance motors and a compact frame with specific geometry with a very centered and low centre of gravity, you will be able to reach the same sites as before, but with extra power. With multiple modes of action on the motor you will be able to control the power transmitted to the pedalier axis through a display in the handlebar. The battery is in charge of the autonomy, lasting more than what can be expected. We benefit from the new E - 8000 engine developed by Shimano: everything so you can enjoy the E - MTB experience.

Descubre una nueva experiencia: el E-MTB. Con los motores eléctricos de asistencia al pedaleo y un cuadro compacto de geometría específica con un centro de gravedad muy centrado y bajo, podrás llegar a los mismos sitios que ya conocías anteriormente, pero contando con un plus añadido en potencia. Con varios modos de acción sobre el motor podrás controlar la potencia transmitida al eje de pedalier a través de un display en el manillar. La batería se encarga de la autonomía, siendo ésta mucho más duradera de lo que se puede esperar. Nos beneficiamos del nuevo motor E - 8000 desarrollado por Shimano: todo para que tu puedas disfrutar de la experiencia E-MTB.



DESIGN AND DEVELOPMENT

Aspe represents the e-MTB technology. Specifically created to have the best experience in handling and transmitting optimum power, from biker to land.

DISEÑO Y DESARROLLO

Aspe representa la tecnología e-MTB. Específicamente creada para tener la mejor experiencia en el manejo y la transmisión de potencia optima, del biker al terreno.

MOTOR

The Shimano engine allows us to get short pods, giving agility. Rigidity is assured with the Boost system.

MOTOR

El motor Shimano nos permite conseguir unas vainas cortas, dando agilidad. Rigidez asegurada con el sistema Boost.



DISPLAY

Extensive choice of power assisting settings to match your unique riding style. Compact, easy-to-read display with dynamic visual images when switching between support settings.





















DISPLAY

Amplia selección de ajustes de asistencia al pedaleo para adaptarse a tu estilo de pedaleo único. Pantalla compacta y de fácil lectura con imágenes dinámicas al cambiar entre los ajustes de asistencia.

29 ASPE FORCE 10 ORANGE



SPECIFICATIONS / ESPECIFICACIONES

 FULL INTEGRATED BATTERY, ALLOY 6061 TRIPLE BUTTED I2xI48 BOOST	 SHIMANO MT201 HYDRAULIC DISC
 ROCK SHOX JUDY AIR, E-BIKE+ TRAVEL 100mm, BOOST I5xI10 + REMOTE POPLOCK LOCKOUT	 FORMULA BOOST 15x110 / 12x148
 FSA ORBIT 1,5 E ZS 1-1/8" 1,5"	 SUNRINGLE INFERNO 25 BOOST 15x110 / 12x148
 ALLOY BUTTED 31,8x720 mm, RISE: 12 mm, BACK SWEEP: 6°	 MAXXIS IKON 29x2,2
 3D FORGED ALLOY, EXT.: 60-70-90 mm, RISE: ±7°	 SRAM NX EAGLE 12s 11-50T
 MEGAMO 31,6	 SHIMANO E8000 250W
 MEGAMO	 INTEGRATED 500 LITIO-ION (LI-ION) 36V - 13,8 Ah - 500 Wh
 SRAM NX EAGLE 12s	 ECO: 125 Km, TRAIL: 100 Km, BOOST: 75 Km
 SHIMANO E-8000	 4 HOURS
 SRAM NX EAGLE 12s	 25 Km/h
	 SHIMANO E8000

*Posibilidad de incorporar dos porta bidones (no incluidos)

* Possibility of incorporating two bottle cages (not included)

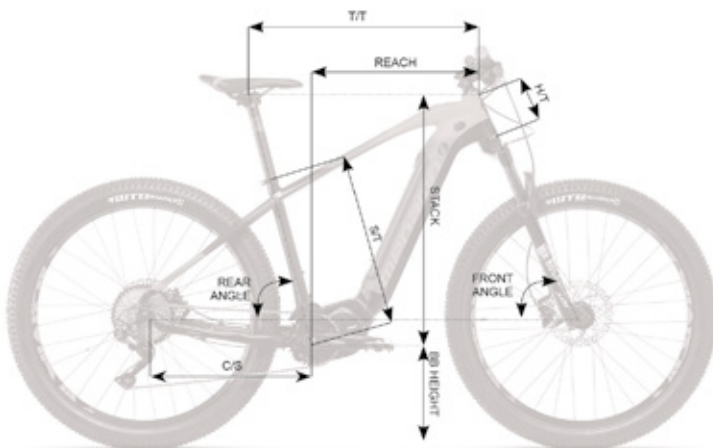











ASPE FORCE 10









	S	M	L
SIZE	15"	17"	20"
T/T	575	593	620
C/S	450	450	450
S/T	381	432	508
H/T	140	140	150
REACH	382	400	424
STACK	651	651	660
BB HEIGHT	-	-	-
FRONT ANGLE	67	67	67
REAR ANGLE	73	73	73

29 ASPE FORCE 10 GREEN



SPECIFICATIONS / ESPECIFICACIONES

-  FULL INTEGRATED BATTERY, ALLOY 6061 TRIPLE BUTTED 12x148 BOOST
-  ROCK SHOX JUDY AIR, E-BIKE+ TRAVEL 100mm, BOOST 15x110 + REMOTE POPLOCK LOCKOUT
-  FSA ORBIT 1,5 E ZS 1-1/8" 1,5"
-  ALLOY BUTTED 31,8x720 mm, RISE: 12 mm, BACK SWEEP: 6°
-  3D FORGED ALLOY, EXT.: 60-70-90 mm, RISE: ±7°
-  MEGAMO 31,6
-  MEGAMO
-  SRAM NX EAGLE 12s
-  SHIMANO E-8000
-  SRAM NX EAGLE 12s

-  SHIMANO MT201 HYDRAULIC DISC
-  FORMULA BOOST 15x110 / 12x148
-  SUNRINGLE INFERNO 25 BOOST 15x110 / 12x148
-  MAXXIS IKON 29x2,2
-  SRAM NX EAGLE 12s 11-50T
-  SHIMANO E8000 250W
-  INTEGRATED 500 Lítio-Ion (Li-Ion) 36V - 13,8 Ah - 500 Wh
-  ECO: 125 Km, TRAIL: 100 Km, BOOST: 75 Km
-  4 HOURS
-  25 Km/h
-  SHIMANO E8000

*Posibilidad de incorporar dos porta bidones (no incluidos)

* Possibility of incorporating two bottle cages (not included)

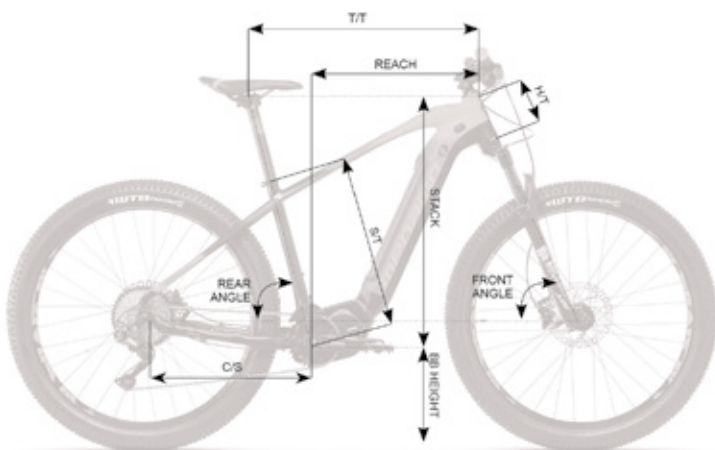











ASPE FORCE 10









	S	M	L
SIZE	15"	17"	20"
T/T	575	593	620
C/S	450	450	450
S/T	381	432	508
H/T	140	140	150
REACH	382	400	424
STACK	651	651	660
BB HEIGHT	-	-	-
FRONT ANGLE	67	67	67
REAR ANGLE	73	73	73

27,5+ ASPE FORCE 10 ORANGE



SPECIFICATIONS / ESPECIFICACIONES

-  FULL INTEGRATED BATTERY, ALLOY 6061 TRIPLE BUTTED 12x148 BOOST
-  ROCK SHOX JUDY AIR, E-BIKE+ TRAVEL 100mm, BOOST 15x110 + REMOTE POPLOCK LOCKOUT
-  FSA ORBIT 1,5 E ZS 1-1/8" 1,5"
-  ALLOY BUTTED 31,8x720 mm, RISE: 12 mm, BACK SWEEP: 6°
-  3D FORGED ALLOY, EXT.: 60-70-90 mm, RISE: ±7°
-  MEGAMO 31,6
-  MEGAMO
-  SRAM NX EAGLE 12s
-  SHIMANO E-8000
-  SRAM NX EAGLE 12s

-  SHIMANO MT201 HYDRAULIC DISC
-  BOOST SYSTEM 15x110 12x148
-  27,5+ BOOST SYSTEM 15x110 12x148 WIDE:40mm
-  WTB RANGER 27,5x2,8 ALL MOUNTAIN 27,5PLUS
-  SRAM NX EAGLE 12s 11-50T
-  SHIMANO E8000 250W
-  INTEGRATED 500 Lítio-Ion (Li-Ion) 36V - 13,8 Ah - 500 Wh
-  ECO: 125 Km, TRAIL: 100 Km, BOOST: 75 Km
-  4 HOURS
-  25 Km/h
-  SHIMANO E8000

*Posibilidad de incorporar dos porta bidones (no incluidos)

* Possibility of incorporating two bottle cages (not included)

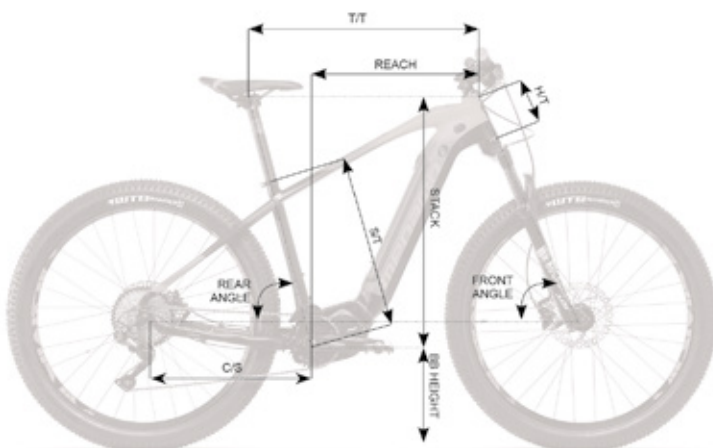











ASPE FORCE 10











	S	M	L
SIZE	15"	17"	20"
T/T	575	593	620
C/S	450	450	450
S/T	381	432	508
H/T	140	140	150
REACH	382	400	424
STACK	651	651	660
BB HEIGHT	-	-	-
FRONT ANGLE	67	67	67
REAR ANGLE	73	73	73

27,5+ ASPE FORCE 10 GREEN



SPECIFICATIONS / ESPECIFICACIONES

-  FULL INTEGRATED BATTERY, ALLOY 6061 TRIPLE BUTTED 12x148 BOOST
-  ROCK SHOX JUDY AIR, E-BIKE+ TRAVEL 100mm, BOOST 15x110 + REMOTE POPLOCK LOCKOUT
-  FSA ORBIT 1,5 E ZS 1-1/8" 1,5"
-  ALLOY BUTTED 31,8x720 mm, RISE: 12 mm, BACK SWEEP: 6°
-  3D FORGED ALLOY, EXT.: 60-70-90 mm, RISE: ±7°
-  MEGAMO 31,6
-  MEGAMO
-  SRAM NX EAGLE 12s
-  SHIMANO E-8000
-  SRAM NX EAGLE 12s

-  SHIMANO MT201 HYDRAULIC DISC
-  BOOST SYSTEM 15x110 12x148
-  27.5+ BOOST SYSTEM 15x110 12x148 WIDE:40mm
-  WTB RANGER 27,5x2,8 ALL MOUNTAIN 27,5PLUS
-  SRAM NX EAGLE 12s 11-50T
-  SHIMANO E8000 250W
-  INTEGRATED 500 Lito-Ion (Li-Ion) 36V - 13,8 Ah - 500 Wh
-  ECO: 125 Km, TRAIL: 100 Km, BOOST: 75 Km
-  4 HOURS
-  25 Km/h
-  SHIMANO E8000

*Posibilidad de incorporar dos porta bidones (no incluidos)

* Possibility of incorporating two bottle cages (not included)

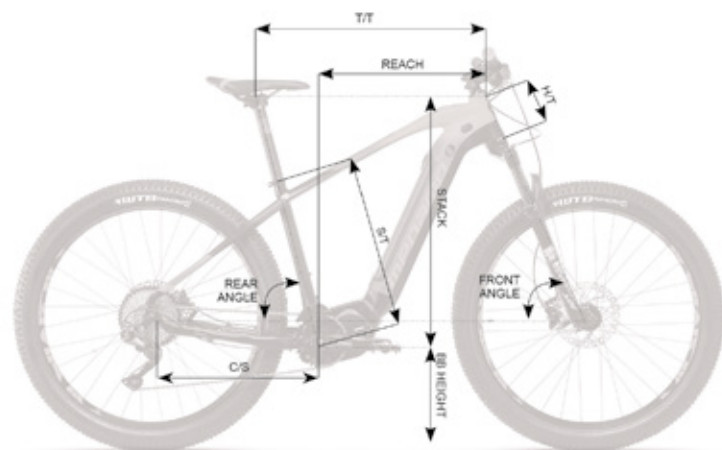





















ASPE FORCE 10

	S	M	L
SIZE	15"	17"	20"
T/T	575	593	620
C/S	450	450	450
S/T	381	432	508
H/T	140	140	150
REACH	382	400	424
STACK	651	651	660
BB HEIGHT	-	-	-
FRONT ANGLE	67	67	67
REAR ANGLE	73	73	73

29 ASPE FORCE 20 ORANGE



SPECIFICATIONS / ESPECIFICACIONES

 FULL INTEGRATED BATTERY, ALLOY 6061 TRIPLE BUTTED 12x148 BOOST	 SHIMANO MT201 HYDRAULIC DISC
 ROCK SHOX JUDY AIR, E-BIKE+ TRAVEL 100mm, BOOST 15x110 + REMOTE POPLOCK LOCKOUT	 FORMULA BOOST 15x110 / 12x148
 FSA ORBIT 1,5 E ZS 1-1/8" 1,5"	 SUNRINGLE INFERNO 25 BOOST 15x110 / 12x148
 ALLOY BUTTED 31,8x720 mm, RISE: 12 mm, BACK SWEEP: 6°	 MAXXIS IKON 29x2,2
 3D FORGED ALLOY, EXT.: 60-70-90 mm, RISE: ±7°	 SHIMANO SLX 7000 11s
 MEGAMO 31,6	 SHIMANO E8000 250W
 MEGAMO	 INTEGRATED 500 Lítio-Ion (Li-Ion) 36V - 13,8 Ah - 500 Wh
 SHIMANO SLX 7000 11s	 ECO: 125 Km, TRAIL: 100 Km, BOOST: 75 Km
 SHIMANO E-8000	 4 HOURS
 SHIMANO SLX 7000 11s	 25 Km/h
	 SHIMANO E8000

*Posibilidad de incorporar dos porta bidones (no incluidos)

* Possibility of incorporating two bottle cages (not included)

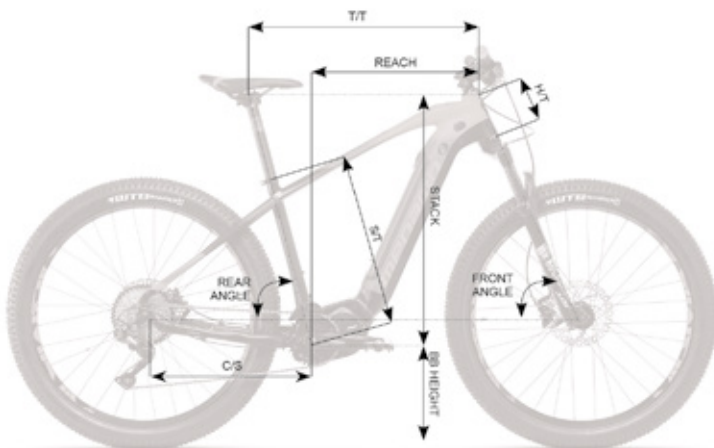











ASPE FORCE 20











	S	M	L
SIZE	15"	17"	20"
T/T	575	593	620
C/S	450	450	450
S/T	381	432	508
H/T	140	140	150
REACH	382	400	424
STACK	651	651	660
BB HEIGHT	-	-	-
FRONT ANGLE	67	67	67
REAR ANGLE	73	73	73

29 ASPE FORCE 20 GREEN



SPECIFICATIONS / ESPECIFICACIONES

-  FULL INTEGRATED BATTERY, ALLOY 6061 TRIPLE BUTTED 12x148 BOOST
-  ROCK SHOX JUDY AIR, E-BIKE+ TRAVEL 100mm, BOOST 15x110 + REMOTE POPLOCK LOCKOUT
-  FSA ORBIT 1,5 E ZS 1-1/8" 1,5"
-  ALLOY BUTTED 31,8x720 mm, RISE: 12 mm, BACK SWEEP: 6°
-  3D FORGED ALLOY, EXT.: 60-70-90 mm, RISE: ±7°
-  MEGAMO 31,6
-  MEGAMO
-  SHIMANO SLX 7000 11s
-  SHIMANO E-8000
-  SHIMANO SLX 7000 11s

-  SHIMANO MT201 HYDRAULIC DISC
-  FORMULA BOOST 15x110 / 12x148
-  SUNRINGLE INFERNO 25 BOOST 15x110 / 12x148
-  MAXXIS IKON 29x2,2
-  SHIMANO SLX 7000 11s
-  SHIMANO E8000 250W
-  INTEGRATED 500 Litio-Ion (Li-Ion) 36V - 13,8 Ah - 500 Wh
-  ECO: 125 Km, TRAIL: 100 Km, BOOST: 75 Km
-  4 HOURS
-  25 Km/h
-  SHIMANO E8000

*Posibilidad de incorporar dos porta bidones (no incluidos)

* Possibility of incorporating two bottle cages (not included)

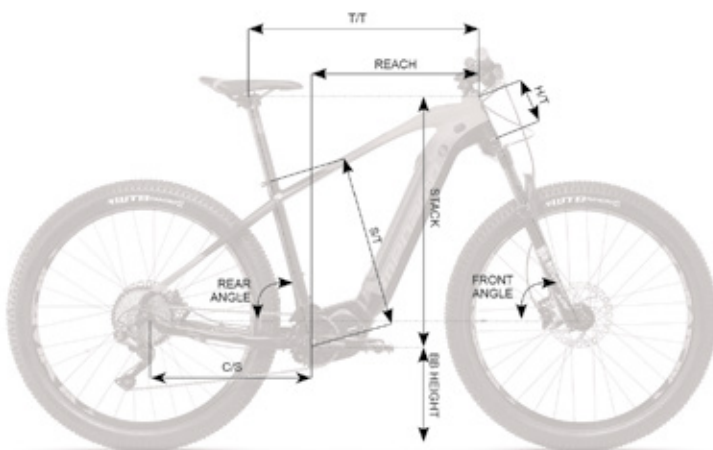











ASPE FORCE 20









	S	M	L
SIZE	15"	17"	20"
T/T	575	593	620
C/S	450	450	450
S/T	381	432	508
H/T	140	140	150
REACH	382	400	424
STACK	651	651	660
BB HEIGHT	-	-	-
FRONT ANGLE	67	67	67
REAR ANGLE	73	73	73

27,5+ ASPE FORCE 20 ORANGE



SPECIFICATIONS / ESPECIFICACIONES

-  FULL INTEGRATED BATTERY, ALLOY 6061 TRIPLE BUTTED I2x148 BOOST
-  ROCK SHOX JUDY AIR, E-BIKE+ TRAVEL 100mm, BOOST I5x110 + REMOTE POPLOCK LOCKOUT
-  FSA ORBIT 1,5 E ZS 1-1/8" 1,5"
-  ALLOY BUTTED 31,8x720 mm, RISE: 12 mm, BACK SWEEP: 6°
-  3D FORGED ALLOY, EXT.: 60-70-90 mm, RISE: ±7°
-  MEGAMO 31,6
-  MEGAMO
-  SHIMANO SLX 7000 11s
-  SHIMANO E-8000
-  SHIMANO SLX 7000 11s

-  SHIMANO MT201 HYDRAULIC DISC
-  BOOST SYSTEM 15x110 12x148
-  27,5+ BOOST SYSTEM 15x110 12x148 WIDE:40mm
-  WTB RANGER 27,5x2,8 ALL MOUNTAIN 27,5PLUS
-  SHIMANO SLX 7000 11s
-  SHIMANO E8000 250W
-  INTEGRATED 500 Lítio-Ion (Li-Ion) 36V - 13,8 Ah - 500 Wh
-  ECO: 125 Km, TRAIL: 100 Km, BOOST: 75 Km
-  4 HOURS
-  25 Km/h
-  SHIMANO E8000

*Posibilidad de incorporar dos porta bidones (no incluidos)

* Possibility of incorporating two bottle cages (not included)

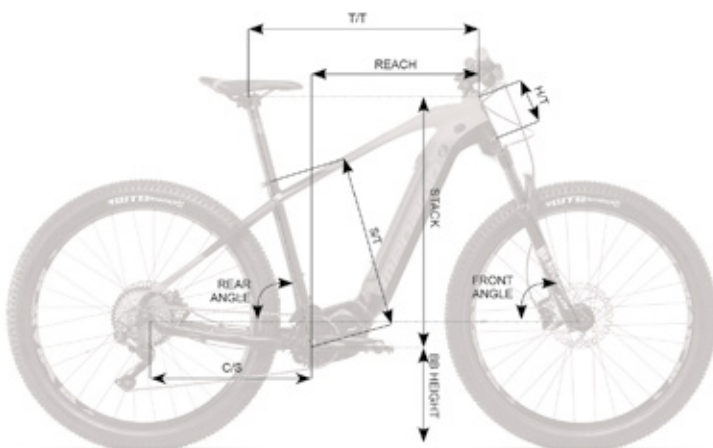











ASPE FORCE 20











	S	M	L
SIZE	15"	17"	20"
T/T	575	593	620
C/S	450	450	450
S/T	381	432	508
H/T	140	140	150
REACH	382	400	424
STACK	651	651	660
BB HEIGHT	-	-	-
FRONT ANGLE	67	67	67
REAR ANGLE	73	73	73

27,5+ ASPE FORCE 20 GREEN



SPECIFICATIONS / ESPECIFICACIONES

-  FULL INTEGRATED BATTERY, ALLOY 6061 TRIPLE BUTTED 12x148 BOOST
-  ROCK SHOX JUDY AIR, E-BIKE+ TRAVEL 100mm, BOOST 15x110 + REMOTE POPLOCK LOCKOUT
-  FSA ORBIT 1,5 E ZS 1-1/8" 1,5"
-  ALLOY BUTTED 31,8x720 mm, RISE: 12 mm, BACK SWEEP: 6°
-  3D FORGED ALLOY, EXT.: 60-70-90 mm, RISE: ±7°
-  MEGAMO 31,6
-  MEGAMO
-  SHIMANO SLX 7000 11s
-  SHIMANO E-8000
-  SHIMANO SLX 7000 11s

-  SHIMANO MT201 HYDRAULIC DISC
-  BOOST SYSTEM 15x110 12x148
-  27.5+ BOOST SYSTEM 15x110 12x148 WIDE:40mm
-  WTB RANGER 27,5x2,8 ALL MOUNTAIN 27,5PLUS
-  SHIMANO SLX 7000 11s
-  SHIMANO E8000 250W
-  INTEGRATED 500 Litio-Ion (Li-Ion) 36V - 13,8 Ah - 500 Wh
-  ECO: 125 Km, TRAIL: 100 Km, BOOST: 75 Km
-  4 HOURS
-  25 Km/h
-  SHIMANO E8000

*Posibilidad de incorporar dos porta bidones (no incluidos)

* Possibility of incorporating two bottle cages (not included)

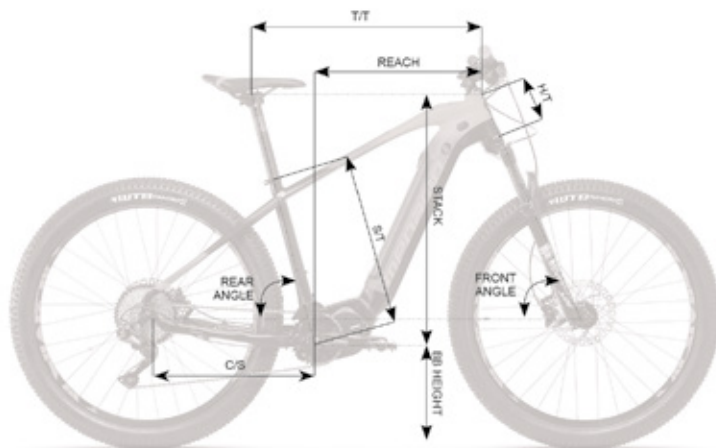











ASPE FORCE 20











	S	M	L
SIZE	15"	17"	20"
T/T	575	593	620
C/S	450	450	450
S/T	381	432	508
H/T	140	140	150
REACH	382	400	424
STACK	651	651	660
BB HEIGHT	-	-	-
FRONT ANGLE	67	67	67
REAR ANGLE	73	73	73

29 ASPE FORCE 30 ORANGE



SPECIFICATIONS / ESPECIFICACIONES

-  FULL INTEGRATED BATTERY, ALLOY 6061 TRIPLE BUTTED 12x148 BOOST
-  SUNTOUR XCR AIR, E-BIKE+, TRAVEL 100mm, BOOST 15x110 + REMOTE LOCKOUT
-  FSA ORBIT 1,5 E ZS 1-1/8" 1,5"
-  ALLOY BUTTED 31,8x720 mm, RISE: 12 mm, BACK SWEEP: 6°
-  3D FORGED ALLOY, EXT.: 60-70-90 mm, RISE: ±7°
-  MEGAMO 31,6
-  MEGAMO
-  SHIMANO DEORE 6000 10s
-  SHIMANO E-8000
-  SHIMANO DEORE 6000 10s

-  SHIMANO MT201 HYDRAULIC DISC
-  FORMULA BOOST 15x110 / 12x148
-  SUNRINGLE INFERNO 25 BOOST 15x110 / 12x148
-  MAXXIS IKON 29x2,2
-  SHIMANO DEORE 6000 11-42T 10s
-  SHIMANO E8000 250W
-  INTEGRATED 500 Lítio-Ion (Li-Ion) 36V - 13,8 Ah - 500 Wh
-  ECO: 125 Km, TRAIL: 100 Km, BOOST: 75 Km
-  4 HOURS
-  25 Km/h
-  SHIMANO E8000

*Posibilidad de incorporar dos porta bidones (no incluidos)

* Possibility of incorporating two bottle cages (not included)

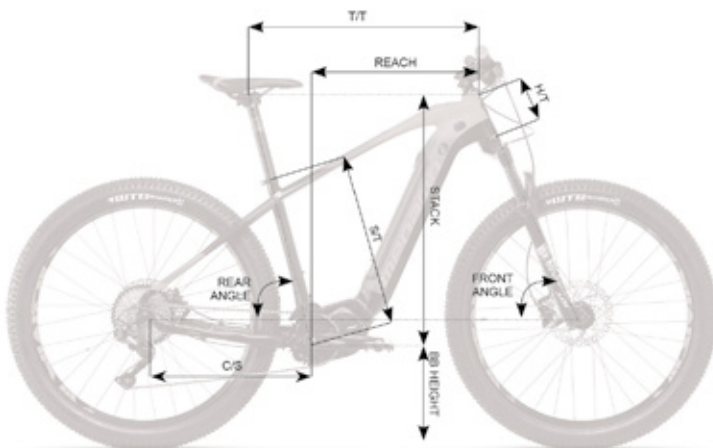











ASPE FORCE 30











	S	M	L
SIZE	15"	17"	20"
T/T	575	593	620
C/S	450	450	450
S/T	381	432	508
H/T	140	140	150
REACH	382	400	424
STACK	651	651	660
BB HEIGHT	-	-	-
FRONT ANGLE	67	67	67
REAR ANGLE	73	73	73

29 ASPE FORCE 30 GREEN



SPECIFICATIONS / ESPECIFICACIONES

-  FULL INTEGRATED BATTERY, ALLOY 6061 TRIPLE BUTTED 12x148 BOOST
-  SUNTOUR XCR AIR, E-BIKE+, TRAVEL 100mm, BOOST 15x110 + REMOTE LOCKOUT
-  FSA ORBIT 1,5 E ZS 1-1/8" 1,5"
-  ALLOY BUTTED 31,8x720 mm, RISE: 12 mm, BACK SWEEP: 6°
-  3D FORGED ALLOY, EXT.: 60-70-90 mm, RISE: ±7°
-  MEGAMO 31,6
-  MEGAMO
-  SHIMANO DEORE 6000 10s
-  SHIMANO E-8000
-  SHIMANO DEORE 6000 10s

-  SHIMANO MT201 HYDRAULIC DISC
-  FORMULA BOOST 15x110 / 12x148
-  SUNRINGLE INFERNO 25 BOOST 15x110 / 12x148
-  MAXXIS IKON 29x2,2
-  SHIMANO DEORE 6000 11-42T 10s
-  SHIMANO E8000 250W
-  INTEGRATED 500 Lito-Ion (Li-Ion) 36V - 13,8 Ah - 500 Wh
-  ECO: 125 Km, TRAIL: 100 Km, BOOST: 75 Km
-  4 HOURS
-  25 Km/h
-  SHIMANO E8000

*Posibilidad de incorporar dos porta bidones (no incluidos)

* Possibility of incorporating two bottle cages (not included)

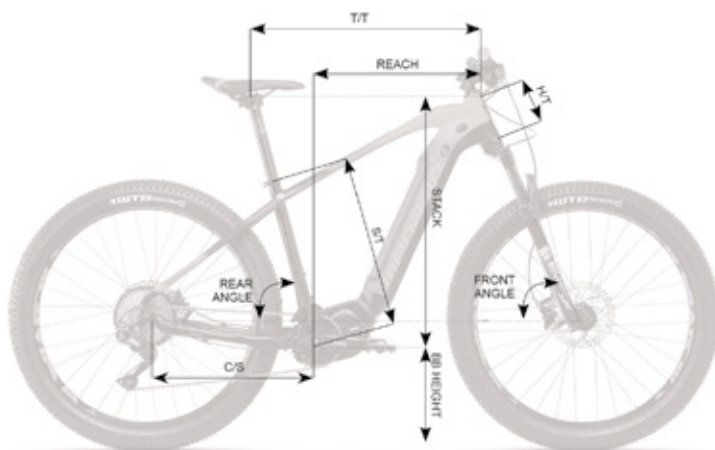











ASPE FORCE 30

	S	M	L
SIZE	15"	17"	20"
T/T	575	593	620
C/S	450	450	450
S/T	381	432	508
H/T	140	140	150
REACH	382	400	424
STACK	651	651	660
BB HEIGHT	-	-	-
FRONT ANGLE	67	67	67
REAR ANGLE	73	73	73

27,5+ ASPE FORCE 30 ORANGE



SPECIFICATIONS / ESPECIFICACIONES

-  FULL INTEGRATED BATTERY, ALLOY 6061 TRIPLE BUTTED 12x148 BOOST
-  SUNTOUR XCR AIR, E-BIKE+, TRAVEL 100mm, BOOST 15x110 + REMOTE LOCKOUT
-  FSA ORBIT 1,5 E ZS 1-1/8" 1,5"
-  ALLOY BUTTED 31,8x720 mm, RISE: 12 mm, BACK SWEEP: 6°
-  3D FORGED ALLOY, EXT.: 60-70-90 mm, RISE: ±7°
-  MEGAMO 31,6
-  MEGAMO
-  SHIMANO DEORE 6000 10s
-  SHIMANO E-8000
-  SHIMANO DEORE 6000 10s

-  SHIMANO MT201 HYDRAULIC DISC
-  BOOST SYSTEM 15x110 12x148
-  27.5+ BOOST SYSTEM 15x110 12x148 WIDE:40mm
-  WTB RANGER 27,5x2,8 ALL MOUNTAIN 27,5PLUS
-  SHIMANO DEORE 6000 11-42T 10s
-  SHIMANO E8000 250W
-  INTEGRATED 500 Litio-Ion (Li-Ion) 36V - 13,8 Ah - 500 Wh
-  ECO: 125 Km, TRAIL: 100 Km, BOOST: 75 Km
-  4 HOURS
-  25 Km/h
-  SHIMANO E8000

*Posibilidad de incorporar dos porta bidones (no incluidos)

* Possibility of incorporating two bottle cages (not included)

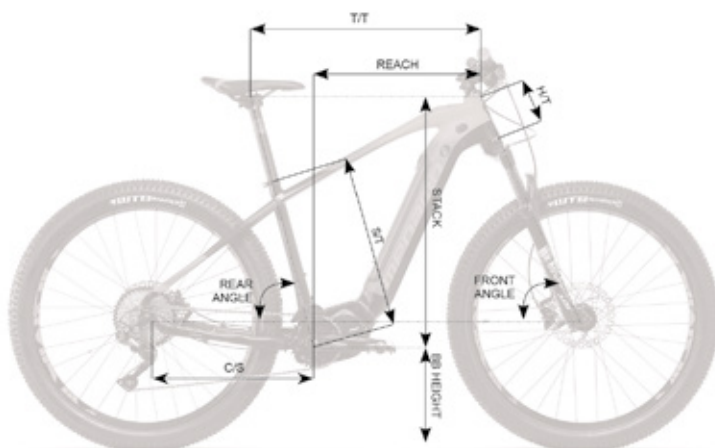





















ASPE FORCE 30

	S	M	L
SIZE	15"	17"	20"
T/T	575	593	620
C/S	450	450	450
S/T	381	432	508
H/T	140	140	150
REACH	382	400	424
STACK	651	651	660
BB HEIGHT	-	-	-
FRONT ANGLE	67	67	67
REAR ANGLE	73	73	73

27,5+ ASPE FORCE 30 GREEN



SPECIFICATIONS / ESPECIFICACIONES

 FULL INTEGRATED BATTERY, ALLOY 6061 TRIPLE BUTTED 12x148 BOOST	 SHIMANO MT201 HYDRAULIC DISC
 SUNTOUR XCR AIR, E-BIKE+, TRAVEL 100mm, BOOST 15x110 + REMOTE LOCKOUT	 BOOST SYSTEM 15x110 12x148
 FSA ORBIT 1,5 E ZS 1-1/8" 1,5"	 27.5+ BOOST SYSTEM 15x110 12x148 WIDE:40mm
 ALLOY BUTTED 31,8x720 mm, RISE: 12 mm, BACK SWEEP: 6°	 WTB RANGER 27,5x2,8 ALL MOUNTAIN 27,5PLUS
 3D FORGED ALLOY, EXT.: 60-70-90 mm, RISE: ±7°	 SHIMANO DEORE 6000 11-42T 10s
 MEGAMO 31,6	 SHIMANO E8000 250W
 MEGAMO	 INTEGRATED 500 Lito-Ion (Li-Ion) 36V - 13,8 Ah - 500 Wh
 SHIMANO DEORE 6000 10s	 ECO: 125 Km, TRAIL: 100 Km, BOOST: 75 Km
 SHIMANO E-8000	 4 HOURS
 SHIMANO DEORE 6000 10s	 25 Km/h
	 SHIMANO E8000

*Posibilidad de incorporar dos porta bidones (no incluidos)

* Possibility of incorporating two bottle cages (not included)

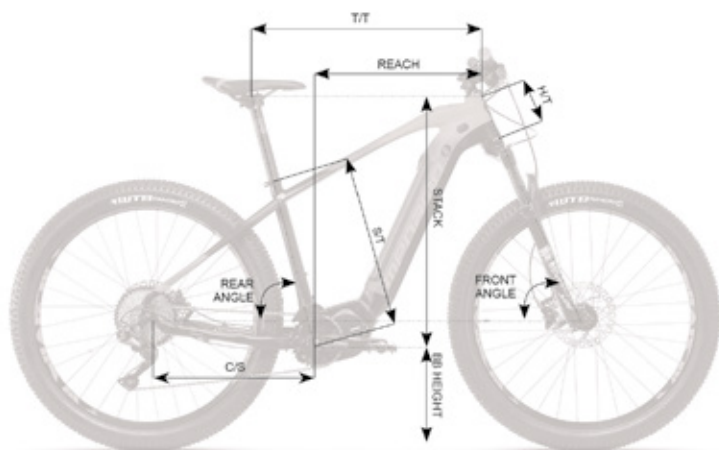























ASPE FORCE 30

	S	M	L
SIZE	15"	17"	20"
T/T	575	593	620
C/S	450	450	450
S/T	381	432	508
H/T	140	140	150
REACH	382	400	424
STACK	651	651	660
BB HEIGHT	-	-	-
FRONT ANGLE	67	67	67
REAR ANGLE	73	73	73

XTREME



SPECIFICATIONS / ESPECIFICACIONES

 ALLOY 6061 HYDROFORMED TUBBING	 TEKTRON HYDRAULIC
 SUNTOUR XCT HLO 100MM TRAVEL	 MEGAMO
 SEMI INTEGRATED	 MEGAMO DOBLE WALL ALLOY DISC
 MEGAMO FOV 31.8	 KENDA 2.2 K-1010
 MEGAMO FOV 31.8	 SHIMANO HG200-9 11-34T
 MEGAMO 27.2	 BRUSHLESS 36V - 250W, W/CLUCH, HIGH-FREQUENCY WATER PROOF CABLE CONNECTOR
 MEGAMO	 LITHIUM, SAMSUNG CELLS BATTERIES, 36V - 11,6 Ah
 SHIMANO ALTUS M370 9s	 40 - 60 Km
 SHIMANO ALTUS M370 3s	 4 - 6 HOURS
 SHIMANO M100 3X9s	 25 Km/h
 SHIMANO ALTUS	 LED DISPLAY - 3 LEVEL ASSISTANCE, BATTERY CHARGE, LIGHTS

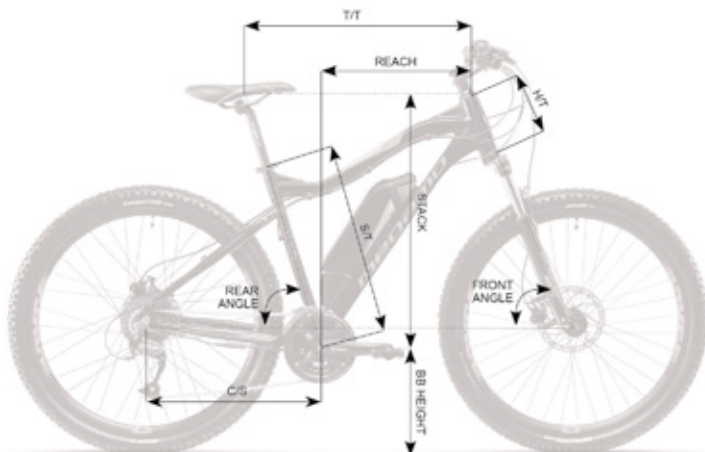

XTREME	29"		27,5"
	M	L	M
T/T	575	610	575
C/S	450	450	440
S/T	483	533	483
H/T	150	160	150
FRONT ANGLE	69	69	69
REAR ANGLE	73,5	73,5	73,5



WEAR/ROPA

KIDS BMX

CITY

TREKKING

FAT

ROAD

MTB

E-BIKES





WEAR/ROPA

KIDS BMX

CITY

TREKKING

FAT

ROAD





















MTB

E-BIKES

28 ROUTE GREY



SPECIFICATIONS / ESPECIFICACIONES

 ALLOY 6061, HYDROFORMED TUBBING, INTERNAL CABLE ROUTING, CENTRAL MOTOR DESIGN, DISC BRAKE	 TEKTRO HYDRAULIC DISC
 SUNTOUR NEX TREKKING FORK DISC BRAKE	 ALLOY HUB 16G 36H
 OVERSIZE	 700C*19 16G*36H F/V
 MEGAMO ALLOY	 K935 700C*40C REFLECTOR LINE, ANTIPUNCTURE TIRES
 MEGAMO ALLOY	 SHIMANO HG41 8s
 MEGAMO ALLOY	 CENTRAL MOTOR TRUCK 36V 250W
 MEGAMO	 36V 13Ah Samsung cells 470Wh
 SHIMANO TX8000 8s	 40 - 80km
 PW 38-165L	 4 -6 Horas
 SHIMANO RS45 8s	 25 Km/h
	 LCD DISPLAY 36V

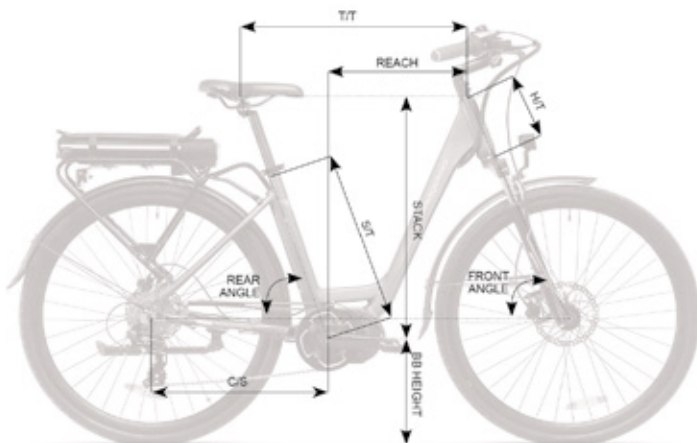

ROUTE 28"

	onesize
T/T	574
C/S	467
S/T	470
H/T	150
FRONT ANGLE	69
REAR ANGLE	72,5

28 ROUTE WHITE



SPECIFICATIONS / ESPECIFICACIONES

 ALLOY 6061, HYDROFORMED TUBING, INTERNAL CABLE ROUTING, CENTRAL MOTOR DESIGN, DISC BRAKE

 SUNTOUR NEX TREKKING FORK DISC BRAKE

 OVERSIZE

 MEGAMO ALLOY

 MEGAMO ALLOY

 MEGAMO ALLOY

 MEGAMO

 SHIMANO TX8000 8s

 PW 38-165L

 SHIMANO RS45 8s

 TEKTRON HYDRAULIC DISC

 ALLOY HUB 16G 36H

 700C*19 16G*36H F/V

 K935 700C*40C REFLECTOR LINE, ANTIPUNCTURE TIRES

 SHIMANO HG41 8s

 CENTRAL MOTOR TRUCK 36V 250W

 36V 13Ah Samsung cells 470Wh

 40 - 80km

 4 - 6 Horas

 25 Km/h

 LCD DISPLAY 36V

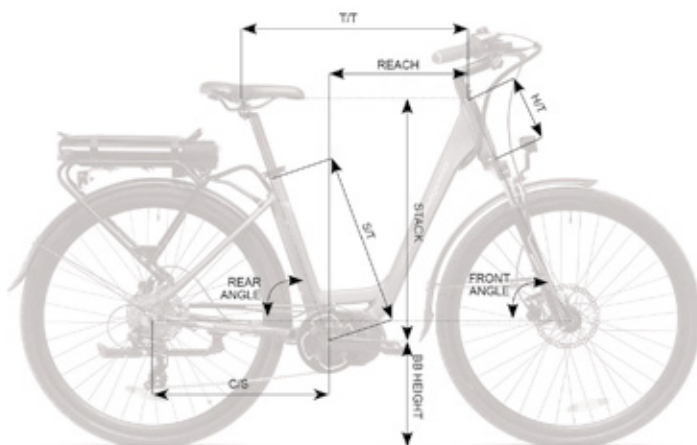

ROUTE

28"











onesize











T/T	574
C/S	467
S/T	470
H/T	150
FRONT ANGLE	69
REAR ANGLE	72,5

28 XPLORA



SPECIFICATIONS / ESPECIFICACIONES

-  ALLOY 6061, HYDROFORMED TUBBING, SPECIFIC FRAME FOR ELECTRIC BICYCLE
-  SUNTOUR NEX HLO
-  SEMI-INTEGRATED
-  MEGAMO ALLOY BUTTED 31,8x700 mm, RISE: 12 mm, BACK SWEEP: 6°
-  MEGAMO
-  MEGAMO 27.2
-  MEGAMO
-  SHIMANO 24s
-  SHIMANO 24s
-  SHIMANO 24s 24x34x44T
-  SHIMANO 24s

-  HYDRAULIC DISC BRAKE, TEKTRO
-  ALLOY HUBS KT, WITH QUICK RELEASE
-  ALLOY DOBLE WALL
-  700 x 40C KENDA K-192, TREKKING TYPE, ANTI-PUNCTURE, WITH REFLECTIVE STRAP
-  SHIMANO 24s
-  BRUSHLESS 36V - 250W, W/CLUCH, HIGH-FREQUENCY WATER PROOF CABLE CONNECTOR
-  LITHIUM, SAMSUNG CELLS BATTERIES, 36V - 11,6 Ah
-  40 - 60 Km
-  4 - 6 HOURS
-  25 Km/h
-  LED DISPLAY - 3 LEVEL ASSISTANCE, BATTERY CHARGE, LIGHTS

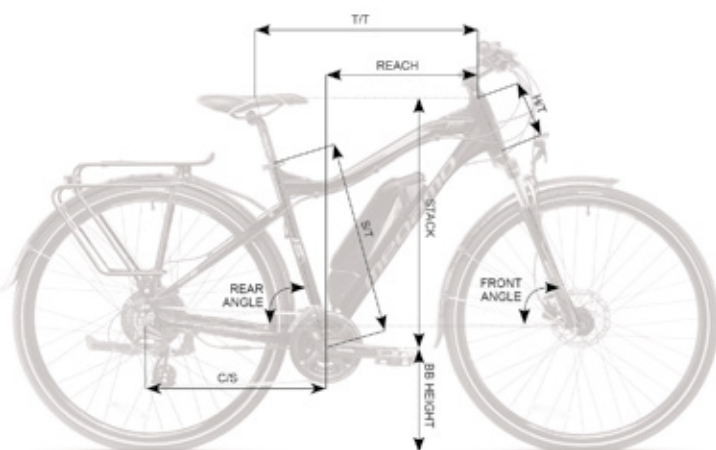

XPLORA

28"

	M	L
T/T	575	610
C/S	450	450
S/T	483	533
H/T	150	160
FRONT ANGLE	69	69
REAR ANGLE	73,5	73,5



WEAR/ROPA

KIDS BMX

CITY

TREKKING

FAT

ROAD

MTB

E-BIKES

EXECUTIVE



The Executive is a folding electric bicycle that will help you move effortlessly, combine it with public transport, store it where you want, have fun in your urban adventures and even in extra-urban due to mixed tires, a little wider and more comfortable.

All these advantages thanks to its lightness, reduced volume, speed of movement and autonomy of the integrated battery.

Avoid traffic jams, save on fuel and maintenance, and above all, enjoy the tour with Executive.

The 250W motor and a removable high-power integrated battery ensure high performance. Also the easy command control with LCD screen where you can manage the different power levels and lights.

La Executive es una bicicleta eléctrica plegable que le ayudara a moverse sin esfuerzo, combinarla con transporte público, guardarla donde quiera, divertirse en sus aventuras urbanas e incluso extra-urbanas gracias a neumáticos mixtos, un poco más anchos y cómodos. Todas estas ventajas gracias a su ligereza, volumen reducido, rapidez de desplazamiento y autonomía de la batería integrada.

Evita atascos de tráfico, ahorra en combustible y mantenimiento, y sobretodo, disfruta del recorrido con Executive.

El motor de 250W y una batería integrada extraíble de alta potencia garantizan un alto rendimiento. También el fácil mando de control con pantalla LCD donde podrá manejar los diferentes niveles de potencia y luces.

DESIGN AND DEVELOPMENT

Lightness, reduced volume, fast movement and integrated battery autonomy are the main qualities of the Executive.

DISEÑO Y DESARROLLO

La ligereza, volumen reducido, rapidez de desplazamiento y autonomía de la batería integrada son las principales cualidades de la Executive.

TOTALLY INTEGRATED BATTERY

Its structure of Samsung lithium cells fully integrated into the bicycle. Providing stability and proper weight distribution and, of course, an avant-garde aesthetic.

BATERIA TOTALMENTE INTEGRADA

Cuenta con una estructura de celdas de litio Samsung totalmente integradas en la bicicleta. Aportando estabilidad y el reparto de pesos adecuado y, por supuesto, una estética vanguardista.



FAST, EASY AND REDUCED VOLUME FOLDING

Designed to be placed in the smallest spaces, as easy and fast as possible.

PLEGADO RAPIDO, FACIL Y VOLUMEN REDUCIDO





















Diseñada para poder situarse en los espacios más reducidos, de la forma más fácil y rápida posible.



18 EXECUTIVE GREY



SPECIFICATIONS / ESPECIFICACIONES

	INTEGRATED BATTERY FOLDING FRAME, ALLOY 6061, INTERNAL CABLE ROUTING, HYDROFORMED TUBBING		DIA-COMPE, ALLOY, W/ ELECTRIC DISCONNECTION FUNCTION
	UNICROWN, HI-TEN		ALLOY
	OVERSIZE		ALLOY WITH CNC SIDES
	ALLOY 25,4x580 mm, 30 mm RISED		18x2,0 ANTI-PUNCTURE W/ REFLECTING LINE
	ALLOY ADJUSTABLE		SHIMANO 7s
	ALLOY		BRUSHLESS 36V - 250W, W/CLUCH, HIGH-FREQUENCY WATER PROOF CABLE CONNECTOR
	MEGAMO		LITHIUM , SAMSUNG CELLS BATTERIES, 36V - 7,8 Ah - 281Wh
	SHIMANO FT35 7s		40 - 60 Km
	48T*160MM		4 Horas
	SHIMANO ROTATIVE 7s RS35		25 Km/h
			LCD DISPLAY

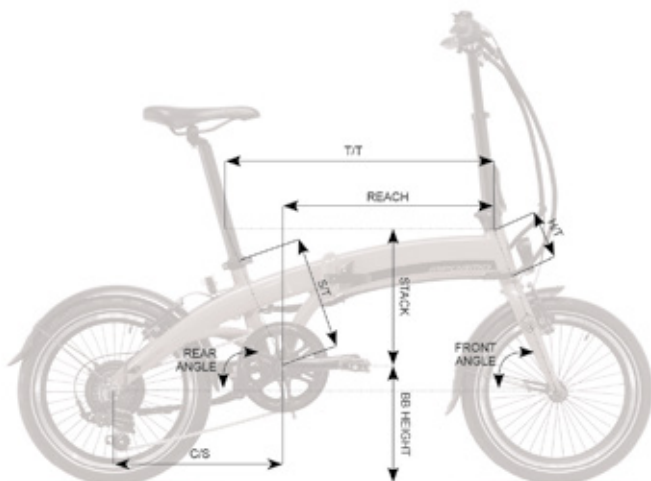





















EXECUTIVE

	one size
SIZE	-
T/T	612
C/S	405
S/T	300
H/T	110

18 EXECUTIVE BLUE



SPECIFICATIONS / ESPECIFICACIONES

-  INTEGRATED BATTERY FOLDING FRAME, ALLOY 6061, INTERNAL CABLE ROUTING, HYDROFORMED TUBING
-  UNICROWN, HI-TEN
-  OVERSIZE
-  ALLOY 25,4x580 mm, 30 mm RISED
-  ALLOY ADJUSTABLE
-  ALLOY
-  MEGAMO
-  SHIMANO FT35 7s
-  48T*160MM
-  SHIMANO ROTATIVE 7s RS35
-  DIA-COMPE, ALLOY, W/ ELECTRIC DISCONNECTION FUNCTION
-  ALLOY
-  ALLOY WITH CNC SIDES
-  18x2,0 ANTI-PUNCTURE W/ REFLECTING LINE
-  SHIMANO 7s
-  BRUSHLESS 36V - 250W, W/CLUTCH, HIGH-FREQUENCY WATER PROOF CABLE CONNECTOR
-  LITHIUM, SAMSUNG CELLS BATTERIES, 36V - 7,8 Ah - 281Wh
-  40 - 60 Km
-  4 Horas
-  25 Km/h
-  LCD DISPLAY

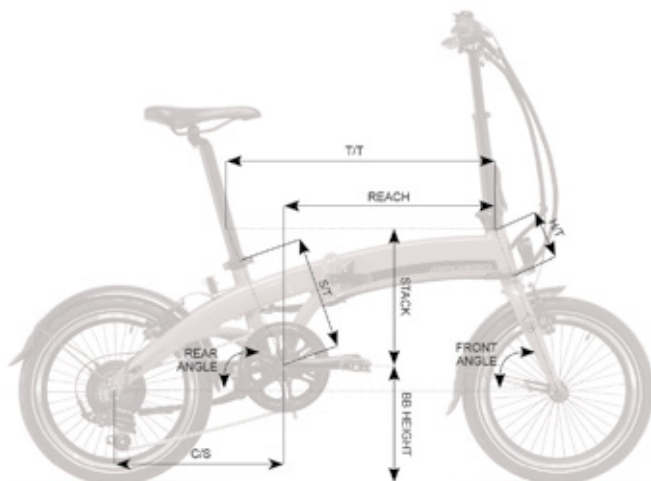





















EXECUTIVE

SIZE	one size
T/T	612
C/S	405
S/T	300
H/T	110

18 EXECUTIVE ORANGE



SPECIFICATIONS / ESPECIFICACIONES

 INTEGRATED BATTERY FOLDING FRAME, ALLOY 6061, INTERNAL CABLE ROUTING, HYDROFORMED TUBING	 DIA-COMPE, ALLOY, W/ ELECTRIC DISCONNECTION FUNCTION
 UNICROWN, HI-TEN	 ALLOY
 OVERSIZE	 ALLOY WITH CNC SIDES
 ALLOY 25,4x580 mm, 30 mm RISED	 18x2,0 ANTI-PUNCTURE W/ REFLECTING LINE
 ALLOY ADJUSTABLE	 SHIMANO 7s
 ALLOY	 BRUSHLESS 36V - 250W, W/CLUCH, HIGH-FREQUENCY WATER PROOF CABLE CONNECTOR
 MEGAMO	 LITHIUM , SAMSUNG CELLS BATTERIES, 36V - 7,8 Ah - 281Wh
 SHIMANO FT35 7s	 40 - 60 Km
 48T*160MM	 4 Horas
 SHIMANO ROTATIVE 7s RS35	 25 Km/h
	 LCD DISPLAY

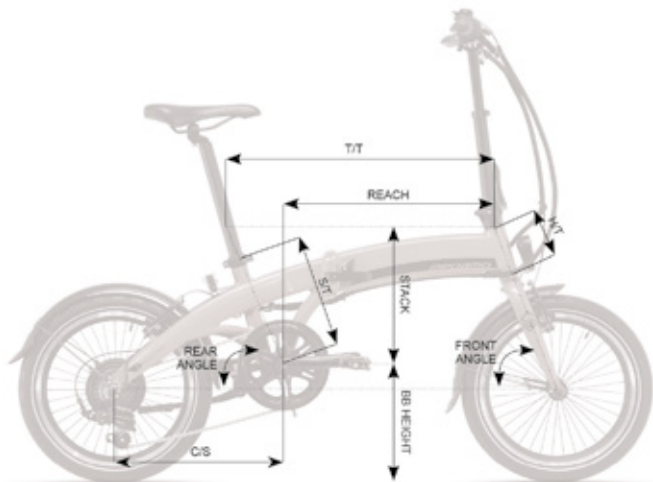

EXECUTIVE

	one size
SIZE	-
T/T	612
C/S	405
S/T	300
H/T	110



E-BIKES

MTB

ROAD

FAT

TREKKING

CITY





















KIDS BMX

WEAR/ROPA

28 TOP CITY GREY



SPECIFICATIONS / ESPECIFICACIONES

 ALLOY 6061, HYDROFORMED TUBBING, INTERNAL CABLE ROUTING	 DIA-COMPE, ALLOY, W/ELECTRIC DISCONNECTION FUNCTION
 TREKKING SUSPENSION FORK	 ALLOY
 OVERSIZE	 ALLOY 700C
 ALLOY 25,4x610 mm, RISED	 28" / 700x38c ANTI-PUNCTURE W/ REFLECTING LINE
 ADJUSTABLE ALLOY, 28,6x110 mm, LENGTH: 180 mm	 SHIMANO 14-32T, 7s
 FORGED ALLOY 27,2x300 mm	 BRUSHLESS 36V - 250W, W/CLUCH, HIGH-FREQUENCY WATER PROOF CABLE CONNECTOR
 MEGAMO	 LITHIUM, SAMSUNG CELLS BATTERIES, 36V - 10,4 Ah - 375Wh
 SHIMANO TX800 7s	 40 - 60 Km
 ALLOY 170 x 42T - SPEED SENSOR, 12 MAGNETIC POINTS	 4 - 6 HOURS
 SHIMANO REVOSHIFT RS36	 25 Km/h
	 LED DISPLAY - 3 LEVEL ASSISTANCE, BATTERY CHARGE, LIGHTS

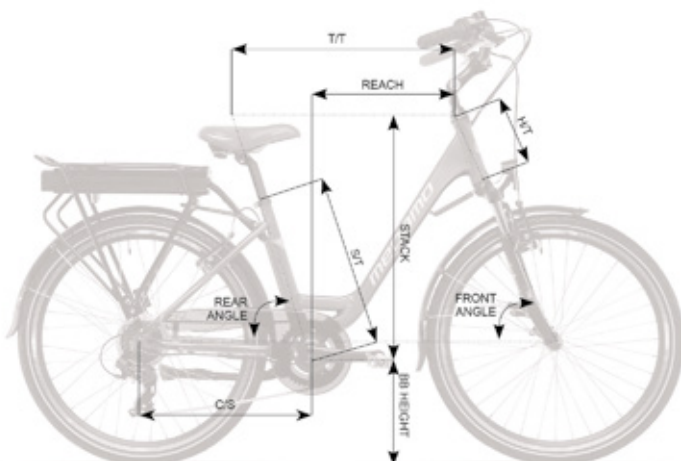











TOP CITY











	onesize
SIZE	16"
T/T	584
C/S	462
S/T	405
H/T	160
REACH	400
STACK	640
FRONT ANGLE	72
REAR ANGLE	74
BB HEIGHT	278

28 TOP CITY WHITE



SPECIFICATIONS / ESPECIFICACIONES

-  ALLOY 6061, HYDROFORMED TUBBING, INTERNAL CABLE ROUTING
-  TREKKING SUSPENSION FORK
-  OVERSIZE
-  ALLOY 25,4x610 mm, RISED
-  ADJUSTABLE ALLOY, 28,6x110 mm, LENGTH: 180 mm
-  FORGED ALLOY 27,2x300 mm
-  MEGAMO
-  SHIMANO TX800 7s
-  ALLOY 170 x 42T - SPEED SENSOR, 12 MAGNETIC POINTS
-  SHIMANO REVOSHIFT RS36

-  DIA-COMPE, ALLOY, W/ELECTRIC DISCONNECTION FUNCTION
-  ALLOY
-  ALLOY 700C
-  28" / 700x38c ANTI-PUNCTURE W/ REFLECTING LINE
-  SHIMANO 14-32T, 7s
-  BRUSHLESS 36V - 250W, W/CLUCH, HIGH-FREQUENCY WATER PROOF CABLE CONNECTOR
-  LITHIUM, SAMSUNG CELLS BATTERIES, 36V - 10,4 Ah - 375Wh
-  40 - 60 Km
-  4 - 6 HOURS
-  25 Km/h
-  LED DISPLAY - 3 LEVEL ASSISTANCE, BATTERY CHARGE, LIGHTS

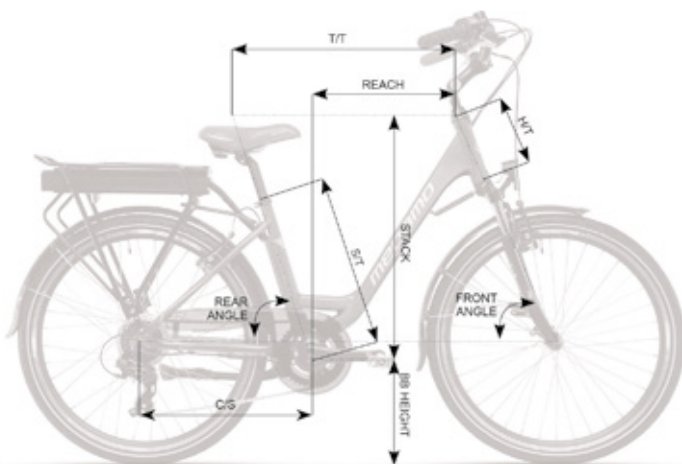





















TOP CITY

SIZE	onesize
SIZE	16"
T/T	584
C/S	462
S/T	405
H/T	160
REACH	400
STACK	640
FRONT ANGLE	72
REAR ANGLE	74
BB HEIGHT	278

26 TOP CITY GREY



SPECIFICATIONS / ESPECIFICACIONES

 ALLOY 6061, HYDROFORMED TUBBING, INTERNAL CABLE ROUTING	 DIA-COMPE, ALLOY, W/ELECTRIC DISCONNECTION FUNCTION
 TREKKING SUSPENSION FORK	 ALLOY
 OVERSIZE	 ALLOY 650C
 ALLOY 25,4x610 mm, RISED	 26" / 650x38c ANTI-PUNCTURE W/ REFLECTING LINE
 ADJUSTABLE ALLOY, 28,6x110 mm, LENGTH: 180 mm	 SHIMANO 14-32T, 7s
 FORGED ALLOY 27,2x300 mm	 BRUSHLESS 36V - 250W, W/CLUCH, HIGH-FREQUENCY WATER PROOF CABLE CONNECTOR
 MEGAMO	 LITHIUM, SAMSUNG CELLS BATTERIES, 36V - 10,4 Ah - 375Wh
 SHIMANO TX800 7s	 40 - 60 Km
 ALLOY 170 x 42T - SPEED SENSOR, 12 MAGNETIC POINTS	 4 - 6 HOURS
 SHIMANO REVOSHIFT RS36 6s	 25 Km/h
	 LED DISPLAY - 3 LEVEL ASSISTANCE, BATTERY CHARGE, LIGHTS

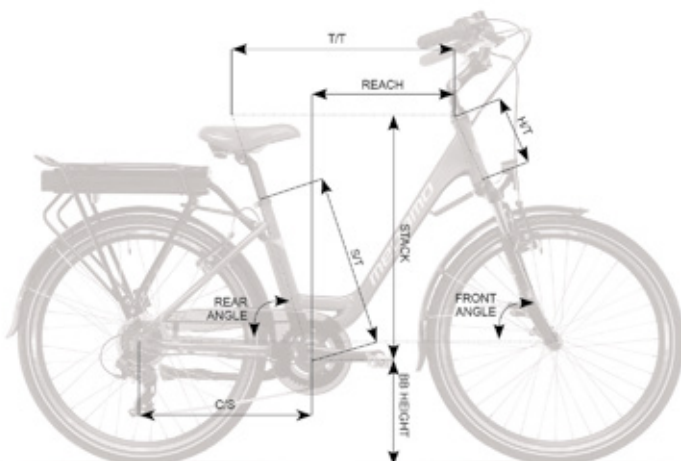











TOP CITY











	onesize
SIZE	16"
T/T	558
C/S	435
S/T	405
H/T	160
REACH	390
STACK	586
FRONT ANGLE	72
REAR ANGLE	74
BB HEIGHT	295

26 TOP CITY WHITE



SPECIFICATIONS / ESPECIFICACIONES

-  ALLOY 6061, HYDROFORMED TUBBING, INTERNAL CABLE ROUTING
-  TREKKING SUSPENSION FORK
-  OVERSIZE
-  ALLOY 25,4x610 mm, RISED
-  ADJUSTABLE ALLOY, 28,6x110 mm, LENGTH: 180 mm
-  FORGED ALLOY 27,2x300 mm
-  MEGAMO
-  SHIMANO TX800 7s
-  ALLOY 170 x 42T - SPEED SENSOR, 12 MAGNETIC POINTS
-  SHIMANO REVOSHIFT RS36 6s

-  DIA-COMPE, ALLOY, W/ELECTRIC DISCONNECTION FUNCTION
-  ALLOY
-  ALLOY 650C
-  26" / 650x38c ANTI-PUNCTURE W/ REFLECTING LINE
-  SHIMANO 14-32T, 7s
-  BRUSHLESS 36V - 250W, W/CLUCH, HIGH-FREQUENCY WATER PROOF CABLE CONNECTOR
-  LITHIUM, SAMSUNG CELLS BATTERIES, 36V - 10,4 Ah - 375Wh
-  40 - 60 Km
-  4 - 6 HOURS
-  25 Km/h
-  LED DISPLAY - 3 LEVEL ASSISTANCE, BATTERY CHARGE, LIGHTS

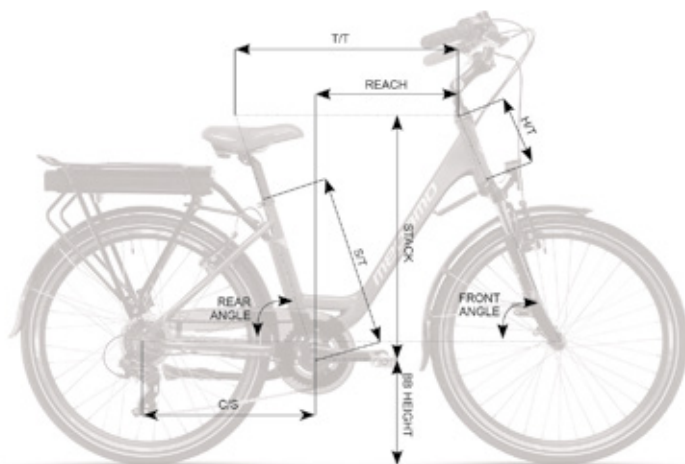

TOP CITY

	onesize
SIZE	16"
T/T	558
C/S	435
S/T	405
H/T	160
REACH	390
STACK	586
FRONT ANGLE	72
REAR ANGLE	74
BB HEIGHT	295

20 CHIP 3.0



SPECIFICATIONS / ESPECIFICACIONES

 ALLOY 6061, FOLDING TYPE, INTERNAL CABLE ROUTING, HYDROFORMED TUBBING

 UNICROWN, HI-TEN

 OVERSIZE

 ALLOY 25,4x580 mm, 30 mm RISED

 ALLOY ADJUSTABLE, LENGTH: 1200 mm + 230 mm

 ALLOY, 31,8x500 mm

 MEGAMO

 SHIMANO FT35 7s

 ALLOY 165x 42T - SPEED SENSOR

 SHIMANO REVOSHIFT RS36

 DIA-COMPE, ALLOY, W/ ELECTRIC DISCONNECTION FUNTION

 ALLOY

 ALLOY WITH CNC SIDES

 20x1,75 ANTI-PUNCTURE W/ REFLECTING LINE

 SHIMANO 14-34T, 7s

 BRUSHLESS 36V - 250W, W/CLUCH, HIGH-FREQUENCY WATER PROOF CABLE CONNECTOR

 LITHIUM , SAMSUNG CELLS BATTERIES, 36V - 7,8 Ah - 281Wh

 40 - 50 Km

 4 - 6 HOURS

 25 Kh/h

 LED DISPLAY

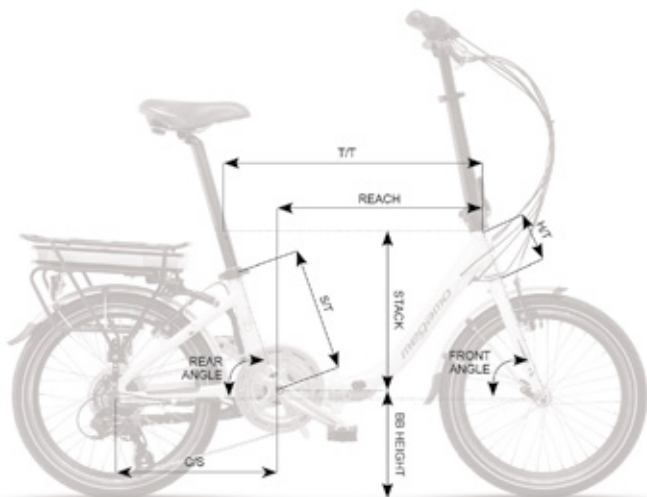

CHIP 3.0 20"

	onesize
SIZE	11"
T/T	578
C/S	400
S/T	282
H/T	100
REACH	438
STACK	344
BB HEIGHT	300
FRONT ANGLE	73°
REAR ANGLE	74°



WEAR/ROPA

KIDS BMX

CITY

TREKKING

FAT

ROAD

MTB

E-BIKES



MAXXIS

megamo

EVOL



megamo

MTB

TRACK

TRACK ELITE ENVE EDITION ORANGE / GREEN / BLACK.....	66-68
TRACK ELITE 01 ORANGE / GREEN / BLACK.....	69-71
TRACK ELITE 03 ORANGE / GREEN / BLACK.....	72-74
TRACK ELITE 05 ORANGE / GREEN / BLACK.....	75-77
TRACK 07 ORANGE / GREEN / BLACK.....	78-80
TRACK 10 ORANGE / GREEN / BLACK.....	81-83

FACTORY

FACTORY ELITE 03 EAGLE ORANGE / GREEN / BLACK.....	88-90
FACTORY ELITE 05 EAGLE ORANGE / GREEN / BLACK.....	91-93
FACTORY 07 EAGLE ORANGE / GREEN / BLACK.....	94-96
FACTORY 15 EAGLE ORANGE / GREEN / BLACK.....	97-99
FACTORY 20 ORANGE / GREEN / BLACK.....	100-102
FACTORY 30 EAGLE ORANGE / GREEN / BLACK.....	103-105
FACTORY 40 ORANGE / GREEN / BLACK.....	106-108

FULL SUSPENSION

XR 05 GREEN / ORANGE.....	112-113
XR 10 GREEN / ORANGE.....	114-115
XC 03.....	118-119

NATURAL

29 NATURAL ELITE 11 EAGLE GREEN / GREY.....	122-123
29 NATURAL ELITE 12 EAGLE GREEN / GREY.....	124-125
29 NATURAL ELITE 13 GREEN / GREY.....	126-127
29 NATURAL ELITE 17 GREEN / GREY.....	128-129
29 NATURAL RC 35 ORANGE / GREY.....	130-131
29 NATURAL RC 37 ORANGE / GREY.....	132-133
29 NATURAL RC 39 ORANGE / GREY.....	134-135
29/27,5 NATURAL 40 ORANGE / GREY.....	136-137
29/27,5 NATURAL 50 GREEN / YELLOW.....	138-139
29/27,5 NATURAL 60 ORANGE / GREEN / YELLOW.....	140-143

SPORT

29/27,5 DX3 BLACK / GREEN.....	144
27,5 FUN BLUE / GREEN.....	145
27,5 FUN LADY GREY / WHITE.....	146
26 KU2 YELLOW / BLACK.....	147
24 KU4.....	148
26 OPEN REPLICA ORANGE / GREY / BLUE / YELLOW.....	149-150
26 OPEN REPLICA LADY GREEN / BLUE / GREY / PINK.....	151-152
24 OPEN JUNIOR BOY ORANGE / YELLOW.....	153
24 OPEN JUNIOR GIRL WHITE / GREEN.....	154

TRACK



When speed and lightness are the maxims, Track is born. With 100mm travel and 29" full carbon frame.

Our world cup bikers have noticed the benefits: improving traction and handling without losing pedaling efficiency. An increased reach and a low stack gives us stability. Angle of the head-tube relaxed to more poise, angle of the saddle allows an effective pedalling, while the short stays get reactive.

Cuando la rapidez y la ligereza es la máxima, nace la Track. Con 100mm de suspensión y cuadro full carbon 29.

Nuestros bikers de la copa del mundo han notado los beneficios: mejorando la tracción y la maniobrabilidad sin perder eficiencia de pedaleo. Un reach aumentado y un stack bajo nos da estabilidad. El ángulo de pipa relajado para más aplomo, el ángulo de sillín permite un pedaleo efectivo, mientras que las vainas cortas consiguen un comportamiento más reactivo.



UCI FACTORY TEAM



SUSPENSION SYSTEM

The swing arm lacks articulation, depending on the bend of the carbon. It brings off greater lightness, mechanical simplicity and reliable operation, simple but extremely effective.

SISTEMA SUSPENSIÓN

El basculante carece de articulación, basándose en la flexión del carbono. Se consigue mayor ligereza, simplicidad mecánica y un funcionamiento fiable, simple pero sumamente efectivo.

REAR AXLE

No axis you've seen before looks like the Easy Remove Axle. The lever of the rear axle is integrated into the body itself. Technology for the user.

EJE TRASERO

Ningún eje que hayas visto antes se parece al Easy Remove Axle. La palanca del eje trasero queda integrada en el cuerpo del mismo. Tecnología al servicio del usuario.

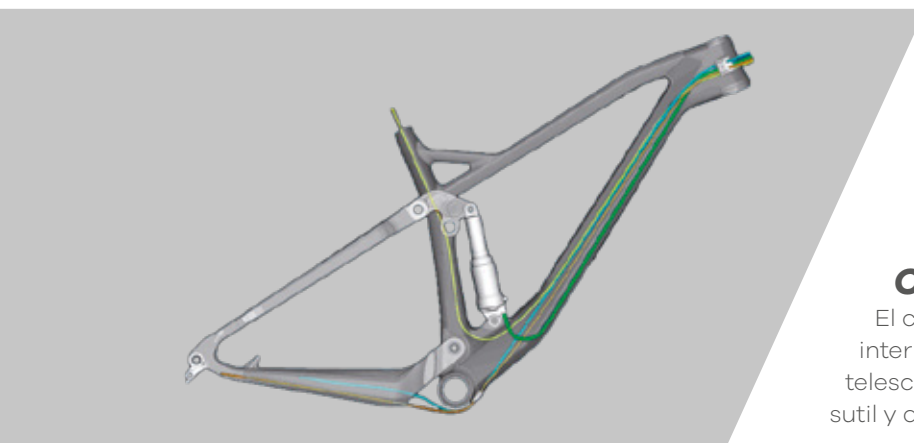
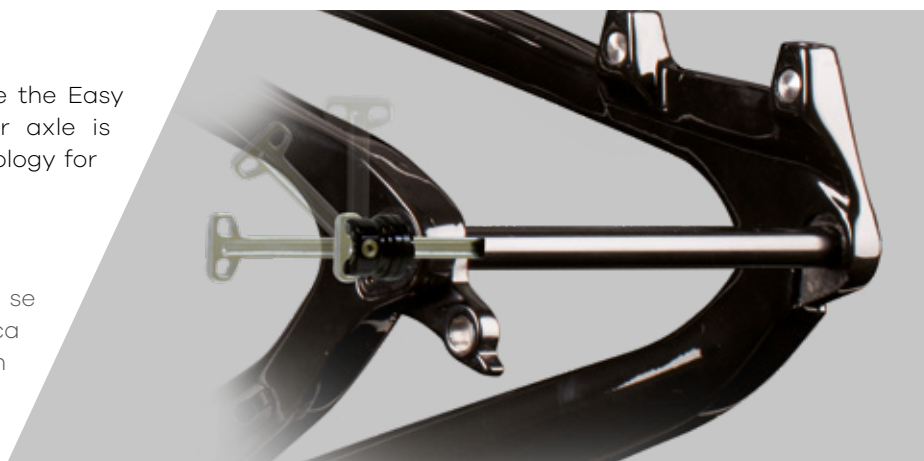

CABLE ROUTING

The frame comes ready for the Smart Design internal wiring. It is compatible with telescopic seat post and Di2. Visual cleanliness for a subtle and attractive design.

CABLEADO INTERNO

El cuadro viene preparado para cableado interno Smart Design. Es compatible con tija telescópica y Di2. Limpieza visual para un diseño sutil y atractivo sin igual.

FULL CARBON FRAME

The frame of the Megamo Track is built entirely with carbon, without inserts of other materials. The new TRACK improves the layout of the multitude of carbon parts that make up the different parts of the frame in precise places and thus increases rigidity and improves driving control. The bottom bracket is BB92, strength and lightness.

CUADRO FULL CARBON

El cuadro de la Megamo Track está construido íntegramente en carbono, sin insertos de otros materiales. La nueva TRACK mejora la disposición de la multitud de piezas de carbono que componen las diferentes partes del cuadro en sitios precisos y así aumenta la rigidez y mejora el control en la conducción. La caja de pedalier es BB92, solidez y ligereza.



TRACK ELITE ENVE EDITION ORANGE



SPECIFICATIONS / ESPECIFICACIONES

 LIGHTWEIGHT FULL CARBON FRAME HIGH MODULE WITH FSC TECHNOLOGY BB92 CARBON SWINGARM BOOST 12X148MM TRAVEL 100MM

 FOX 32 FACTORY STEPCAST KASHIMA FIT4 100 mm REMOTE LOCKOUT, 15x110 BOOST

 FOX FLOAT DPS FACTORY KASHIMA Remote Evol LV MEGAMO Custom Reb. Adj. Travel 100 Locjout 165x38mm

 FSA 1-1/8 1-1/2 * 1.5 TAPERED CARBON

 ENVE - Bar MTB Sweep 760mm

 ENVE STEM

 ENVE 31,6

 SELLE ITALIA X-LR CARBON RAIL

 SRAM XX1 EAGLE 12s

 SRAM XX1 EAGLE 12s DUB

 SRAM XX1 EAGLE 12s

 SRAM LEVEL ULTIMATE

 DT SWIS 240 CL 15x110 / 12x148 BOOST

 ENVE M525 CARBON FIBER WHEELSET

 MAXXIS IKON 29X2,2 SKINWALL EXO 3D TR

 SRAM XX1 EAGLE 10-50T 12s GOLD

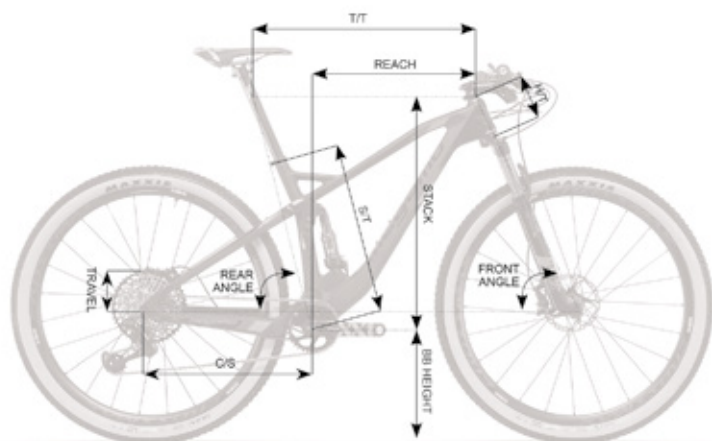

TRACK ELITE ENVE

	S	M	L	XL
SIZE	15,5"	17,5"	19"	21"
T/T	568	600	627	650
C/S	435	435	435	435
S/T	395	445	483	520
H/T	95	95	105	115
REACH	399	432	457	488
STACK	584	584	594	603
BB HEIGHT	308	308	308	308
FRONT ANGLE	69	69	69	69
REAR ANGLE	74	74	74	75

TRACK ELITE ENVE EDITION GREEN

E-BIKES

MTB

ROAD

FAT

TREKKING

















CITY

KIDS BMX

WEAR/ROPA



SPECIFICATIONS / ESPECIFICACIONES

-  LIGHTWEIGHT FULL CARBON FRAME HIGH MODULE WITH FSC TECHNOLOGY BB92 CARBON SWINGARM BOOST 12X148MM TRAVEL 100MM
-  FOX 32 FACTORY STEPCAST KASHIMA FIT4 100 mm REMOTE LOCKOUT, 15x110 BOOST
-  FOX FLOAT DPS FACTORY KASHIMA Remote Evol LV MEGAMO Custom Reb. Adj. Travel 100 Locjout 165x38mm
-  FSA 1-1/8 1-1/2 * 1.5 TAPERED CARBON
-  ENVE - Bar MTB Sweep 760mm
-  ENVE STEM
-  ENVE 31,6
-  SELLE ITALIA X-LR CARBON RAIL
-  SRAM XX1 EAGLE 12s
-  SRAM XX1 EAGLE 12s DUB
-  SRAM XX1 EAGLE 12s
-  SRAM LEVEL ULTIMATE
-  DT SWIS 240 CL 15x110 / 12x148 BOOST
-  ENVE M525 CARBON FIBER WHEELSET
-  MAXXIS IKON 29X2,2 SKINWALL EXO 3D TR
-  SRAM XX1 EAGLE 10-50T 12s GOLD

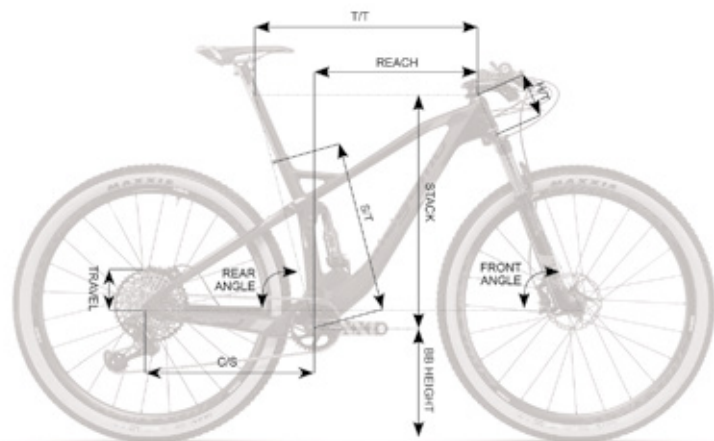

TRACK ELITE ENVE

	S	M	L	XL
SIZE	15,5"	17,5"	19"	21"
T/T	568	600	627	650
C/S	435	435	435	435
S/T	395	445	483	520
H/T	95	95	105	115
REACH	399	432	457	488
STACK	584	584	594	603
BB HEIGHT	308	308	308	308
FRONT ANGLE	69	69	69	69
REAR ANGLE	74	74	74	75

TRACK ELITE ENVE EDITION BLACK



SPECIFICATIONS / ESPECIFICACIONES

 LIGHTWEIGHT FULL CARBON FRAME HIGH MODULE WITH FSC TECHNOLOGY BB92 CARBON SWINGARM BOOST 12X148MM TRAVEL 100MM

 FOX 32 FACTORY STEPCAST KASHIMA FIT4 100 mm REMOTE LOCKOUT, 15x110 BOOST

 FOX FLOAT DPS FACTORY KASHIMA Remote Evol LV MEGAMO Custom Reb. Adj. Travel 100 Locjout 165x38mm

 FSA 1-1/8 1-1/2 * 1.5 TAPERED CARBON

 ENVE - Bar MTB Sweep 760mm

 ENVE STEM

 ENVE 31,6

 SELLE ITALIA X-LR CARBON RAIL

 SRAM XX1 EAGLE 12s

 SRAM XX1 EAGLE 12s DUB

 SRAM XX1 EAGLE 12s

 SRAM LEVEL ULTIMATE

 DT SWIS 240 CL 15x110 / 12x148 BOOST

 ENVE M525 CARBON FIBER WHEELSET

 MAXXIS IKON 29X2,2 SKINWALL EXO 3D TR

 SRAM XX1 EAGLE 10-50T 12s GOLD

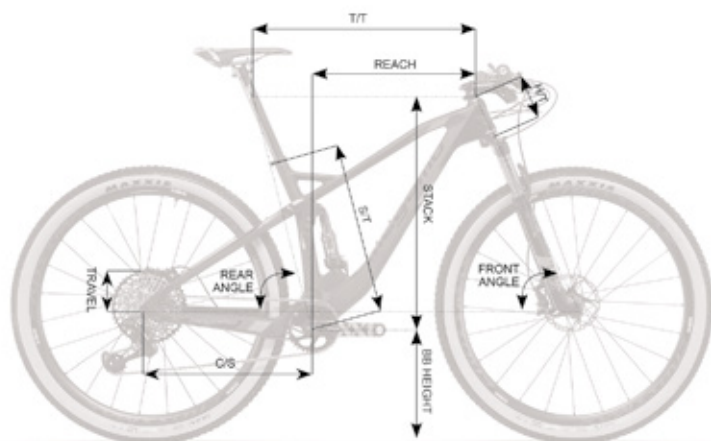

TRACK ELITE ENVE

	S	M	L	XL
SIZE	15,5"	17,5"	19"	21"
T/T	568	600	627	650
C/S	435	435	435	435
S/T	395	445	483	520
H/T	95	95	105	115
REACH	399	432	457	488
STACK	584	584	594	603
BB HEIGHT	308	308	308	308
FRONT ANGLE	69	69	69	69
REAR ANGLE	74	74	74	75

TRACK ELITE 01 ORANGE





SPECIFICATIONS / ESPECIFICACIONES

 LIGHTWEIGHT FULL CARBON FRAME HIGH MODULE WITH FSC TECHNOLOGY BB92 CARBON SWINGARM BOOST 12X148MM TRAVEL 100MM

 FOX 32 FACTORY STEPCAST KASHIMA FIT4 100 mm REMOTE LOCKOUT, 15x110 BOOST

 FOX FLOAT DPS FACTORY KASHIMA Remote Evol LV MEGAMO Custom Reb. Adj. Travel 100 Locjout 165x38mm

 FSA 1-1/8 1-1/2 * 1.5 TAPERED CARBON

 MEGAMO CARBON 710mm

 MEGAMO ADVANCED 17°

 MEGAMO FACTORY ELITE 31,6mm

 SELLE ITALIA X-LR TITANIUM RAIL

 SRAM XX1 EAGLE 12s

 SRAM XX1 EAGLE 12s DUB

 SRAM XX1 EAGLE 12s

 SHIMANO XT 8000

 MAVIC CROSSMAX ELITE CARBON 15X110 BOOST / 12X148 BOOST

 MAVIC CROSSMAX ELITE CARBON 15X110 BOOST / 12X148 BOOST

 MAXXIS IKON 29X2,2 SKINWALL EXO 3D TR

 SRAM XX1 EAGLE 10-50T 12s GOLD

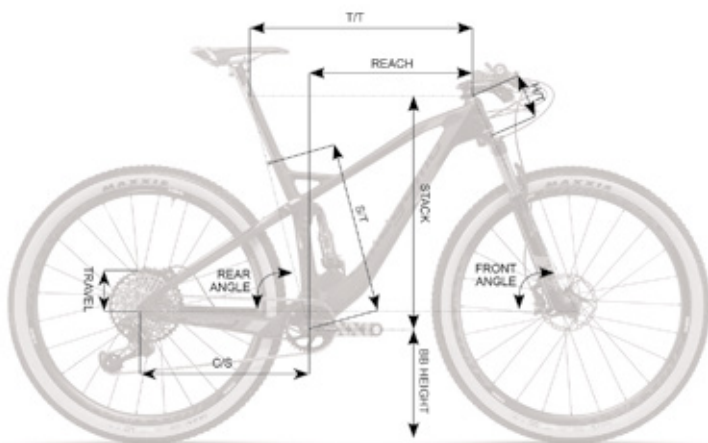

TRACK ELITE 01

	S	M	L	XL
SIZE	15,5"	17,5"	19"	21"
T/T	568	600	627	650
C/S	435	435	435	435
S/T	395	445	483	520
H/T	95	95	105	115
REACH	399	432	457	488
STACK	584	584	594	603
BB HEIGHT	308	308	308	308
FRONT ANGLE	69	69	69	69
REAR ANGLE	74	74	74	75

TRACK ELITE 01 GREEN





SPECIFICATIONS / ESPECIFICACIONES

 LIGHTWEIGHT FULL CARBON FRAME HIGH MODULE WITH FSC TECHNOLOGY BB92 CARBON SWINGARM BOOST 12X148MM TRAVEL 100MM

 FOX 32 FACTORY STEPCAST KASHIMA FIT4 100 mm REMOTE LOCKOUT, 15x110 BOOST

 FOX FLOAT DPS FACTORY KASHIMA Remote Evol LV MEGAMO Custom Reb. Adj. Travel 100 Locjout 165x38mm

 FSA 1-1/8 1-1/2 * 1.5 TAPERED CARBON

 MEGAMO CARBON 710mm

 MEGAMO ADVANCED 17°

 MEGAMO FACTORY ELITE 31,6mm

 SELLE ITALIA X-LR TITANIUM RAIL

 SRAM XX1 EAGLE 12s

 SRAM XX1 EAGLE 12s DUB

 SRAM XX1 EAGLE 12s

 SHIMANO XT 8000

 MAVIC CROSSMAX ELITE CARBON 15X110 BOOST / 12X148 BOOST

 MAVIC CROSSMAX ELITE CARBON 15X110 BOOST / 12X148 BOOST

 MAXXIS IKON 29X2,2 SKINWALL EXO 3D TR

 SRAM XX1 EAGLE 10-50T 12s GOLD

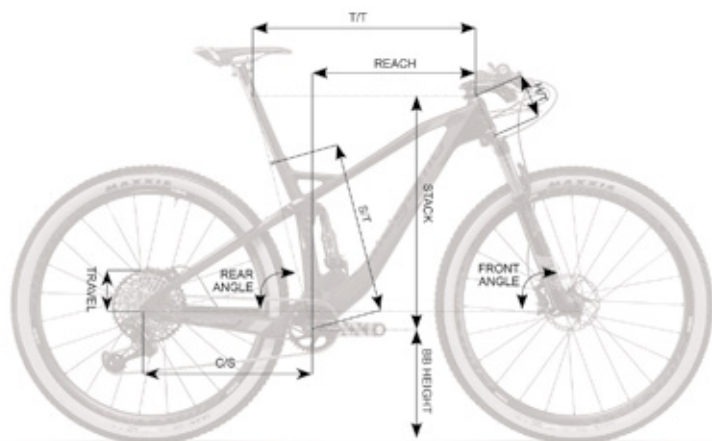

















TRACK ELITE 01

	S	M	L	XL
SIZE	15,5"	17,5"	19"	21"
T/T	568	600	627	650
C/S	435	435	435	435
S/T	395	445	483	520
H/T	95	95	105	115
REACH	399	432	457	488
STACK	584	584	594	603
BB HEIGHT	308	308	308	308
FRONT ANGLE	69	69	69	69
REAR ANGLE	74	74	74	75

TRACK ELITE 01 BLACK



SPECIFICATIONS / ESPECIFICACIONES

<ul style="list-style-type: none">  LIGHTWEIGHT FULL CARBON FRAME HIGH MODULE WITH FSC TECHNOLOGY BB92 CARBON SWINGARM BOOST 12X148MM TRAVEL 100MM  FOX 32 FACTORY STEPCAST KASHIMA FIT4 100 mm REMOTE LOCKOUT, 15x110 BOOST  FOX FLOAT DPS FACTORY KASHIMA Remote Evol LV MEGAMO Custom Reb. Adj. Travel 100 Locjout 165x38mm  FSA 1-1/8 1-1/2 * 1.5 TAPERED CARBON  MEGAMO CARBON 710mm  MEGAMO ADVANCED 17°  MEGAMO FACTORY ELITE 31,6mm 	<ul style="list-style-type: none">  SELLE ITALIA X-LR TITANIUM RAIL  SRAM XX1 EAGLE 12s  SRAM XX1 EAGLE 12s DUB  SRAM XX1 EAGLE 12s  SHIMANO XT 8000  MAVIC CROSSMAX ELITE CARBON 15X110 BOOST / 12X148 BOOST  MAVIC CROSSMAX ELITE CARBON 15X110 BOOST / 12X148 BOOST  MAXXIS IKON 29X2,2 SKINWALL EXO 3D TR  SRAM XX1 EAGLE 10-50T 12s GOLD
---	---

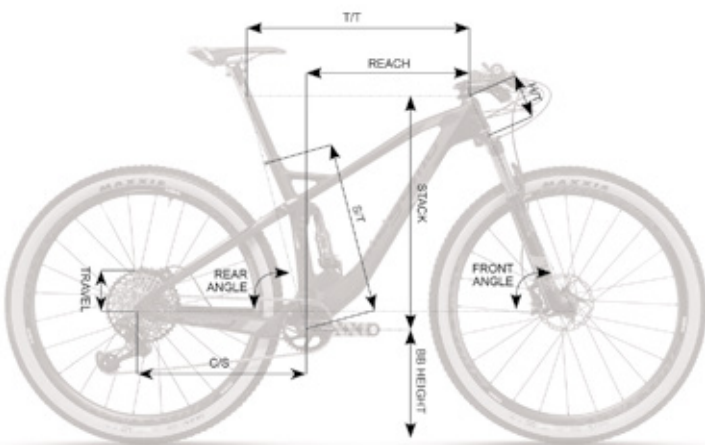

TRACK ELITE 01

	S	M	L	XL
SIZE	15,5"	17,5"	19"	21"
T/T	568	600	627	650
C/S	435	435	435	435
S/T	395	445	483	520
H/T	95	95	105	115
REACH	399	432	457	488
STACK	584	584	594	603
BB HEIGHT	308	308	308	308
FRONT ANGLE	69	69	69	69
REAR ANGLE	74	74	74	75

TRACK ELITE 03 ORANGE





SPECIFICATIONS / ESPECIFICACIONES

 29 TRACK FS Full Carbon Construction FSC Technology BB92 Carbon Swingarm Boost 12x148mm Travel 100mm

 FOX 32 FACTORY STEPCAST KASHIMA FIT4 100 mm REMOTE LOCKOUT, 15x110 BOOST

 FOX FLOAT DPS FACTORY KASHIMA Remote Evol LV MEGAMO Custom Reb. Adj. Travel 100 Locjout 165x38mm

 FSA 1-1/8 1-1/2 * 1.5 TAPERED

 MEGAMO CARBON 710mm

 MEGAMO ADVANCED 17°

 MEGAMO FACTORY ELITE 31,6mm

 SELLE ITALIA X-LR TITANIUM RAIL

 SRAM XO EAGLE 12s

 SRAM XO EAGLE 12s

 SRAM XO EAGLE 12s

 SHIMANO XT 8000

 MAVIC CROSSMAX PRO 15X110 BOOST / 12X148 BOOST

 MAVIC CROSSMAX PRO 15X110 BOOST / 12X148 BOOST

 MAXXIS IKON 29X2,2 SKINWALL EXO 3D TR

 SRAM XO EAGLE 11-50T 12s

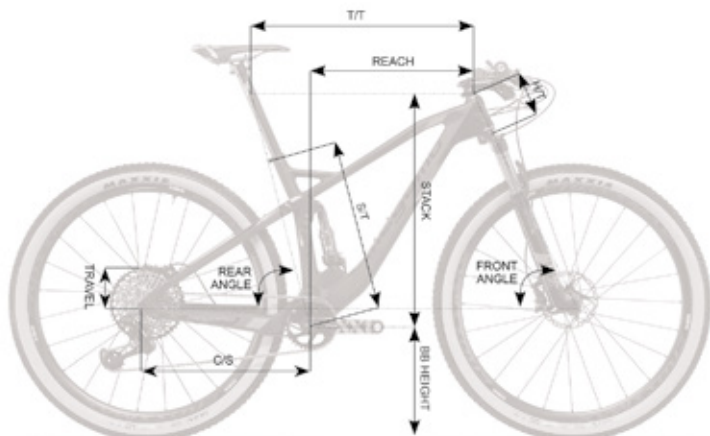

TRACK ELITE 03

	S	M	L	XL
SIZE	15,5"	17,5"	19"	21"
T/T	568	600	627	650
C/S	435	435	435	435
S/T	395	445	483	520
H/T	95	95	105	115
REACH	399	432	457	488
STACK	584	584	594	603
BB HEIGHT	308	308	308	308
FRONT ANGLE	69	69	69	69
REAR ANGLE	74	74	74	75

TRACK ELITE 03 GREEN



SPECIFICATIONS / ESPECIFICACIONES

 29 TRACK FS Full Carbon Construction FSC Technology BB92 Carbon Swingarm Boost 12x148mm Travel 100mm

 FOX 32 FACTORY STEPCAST KASHIMA FIT4 100 mm REMOTE LOCKOUT, 15x110 BOOST

 FOX FLOAT DPS FACTORY KASHIMA Remote Evol LV MEGAMO Custom Reb. Adj. Travel 100 Locjout 165x38mm

 FSA 1-1/8 1-1/2 * 1.5 TAPERED

 MEGAMO CARBON 710mm

 MEGAMO ADVANCED 17°

 MEGAMO FACTORY ELITE 31,6mm

 SELLE ITALIA X-LR TITANIUM RAIL

 SRAM X0 EAGLE 12s

 SRAM X0 EAGLE 12s

 SRAM X0 EAGLE 12s

 SHIMANO XT 8000

 MAVIC CROSSMAX PRO 15X110 BOOST / 12X148 BOOST

 MAVIC CROSSMAX PRO 15X110 BOOST / 12X148 BOOST

 MAXXIS IKON 29X2,2 SKINWALL EXO 3D TR

 SRAM X0 EAGLE 11-50T 12s

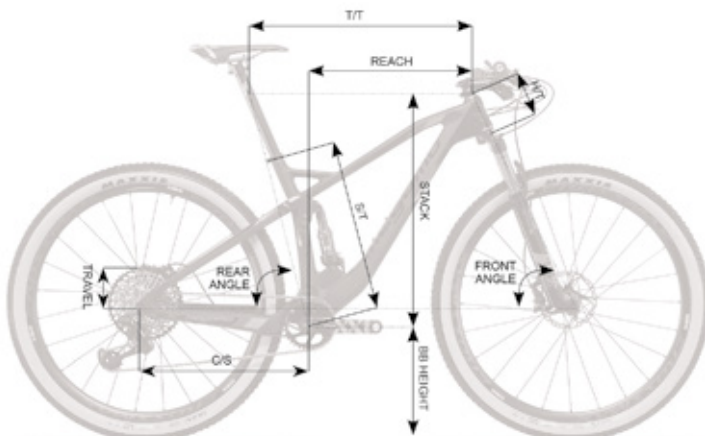

TRACK ELITE 03

	S	M	L	XL
SIZE	15,5"	17,5"	19"	21"
T/T	568	600	627	650
C/S	435	435	435	435
S/T	395	445	483	520
H/T	95	95	105	115
REACH	399	432	457	488
STACK	584	584	594	603
BB HEIGHT	308	308	308	308
FRONT ANGLE	69	69	69	69
REAR ANGLE	74	74	74	75

TRACK ELITE 03 BLACK





SPECIFICATIONS / ESPECIFICACIONES

 29 TRACK FS Full Carbon Construction FSC Technology BB92 Carbon Swingarm Boost 12x148mm Travel 100mm

 FOX 32 FACTORY STEPCAST KASHIMA FIT4 100 mm REMOTE LOCKOUT, 15x110 BOOST

 FOX FLOAT DPS FACTORY KASHIMA Remote Evol LV MEGAMO Custom Reb. Adj. Travel 100 Locjout 165x38mm

 FSA 1-1/8 1-1/2 * 1.5 TAPERED

 MEGAMO CARBON 710mm

 MEGAMO ADVANCED 17°

 MEGAMO FACTORY ELITE 31,6mm

 SELLE ITALIA X-LR TITANIUM RAIL

 SRAM XO EAGLE 12s

 SRAM XO EAGLE 12s

 SRAM XO EAGLE 12s

 SHIMANO XT 8000

 MAVIC CROSSMAX PRO 15X110 BOOST / 12X148 BOOST

 MAVIC CROSSMAX PRO 15X110 BOOST / 12X148 BOOST

 MAXXIS IKON 29X2,2 SKINWALL EXO 3D TR

 SRAM XO EAGLE 11-50T 12s

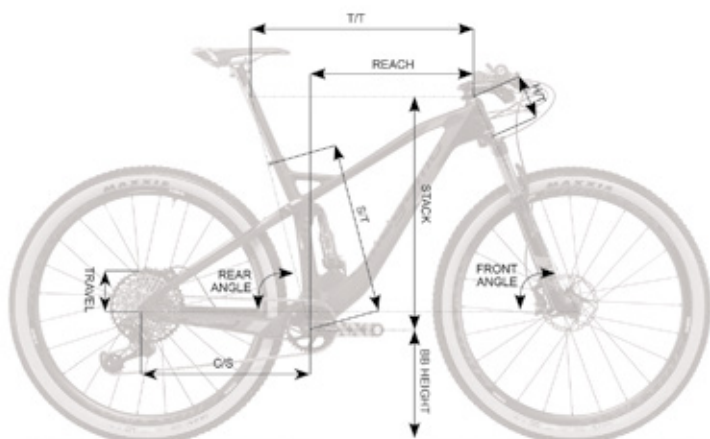

TRACK ELITE 03

	S	M	L	XL
SIZE	15,5"	17,5"	19"	21"
T/T	568	600	627	650
C/S	435	435	435	435
S/T	395	445	483	520
H/T	95	95	105	115
REACH	399	432	457	488
STACK	584	584	594	603
BB HEIGHT	308	308	308	308
FRONT ANGLE	69	69	69	69
REAR ANGLE	74	74	74	75

TRACK ELITE 05 ORANGE

E-BIKES

MTB

ROAD

FAT

TREKKING

CITY

KIDS BMX

WEAR/ROPA





SPECIFICATIONS / ESPECIFICACIONES

 29 TRACK FS Full Carbon Construction FSC Technology BB92 Carbon Swingarm Boost 12x148mm Travel 100mm

 FOX 32 FACTORY STEPCAST KASHIMA FIT4 100 mm REMOTE LOCKOUT, 15x110 BOOST

 FOX FLOAT DPS FACTORY KASHIMA Remote Evol LV MEGAMO Custom Reb. Adj. Travel 100 Locjout 165x38mm

 FSA 1-1/8 1-1/2 * 1.5 TAPERED

 MEGAMO CARBON 710mm

 MEGAMO ADVANCED 17°

 MEGAMO FACTORY ELITE 31,6mm

 SELLE ITALIA X-LR TITANIUM RAIL

 SRAM GX EAGLE 12s

 SRAM STYLO 32 T 12 s

 SRAM GX EAGLE 12s

 SHIMANO XT 8000

 MAVIC CROSSMAX ELITE 15X110 BOOST / 12X148 BOOST

 MAVIC CROSSMAX ELITE 15X110 BOOST / 12X148 BOOST

 MAXXIS IKON 29X2,2 SKINWALL EXO 3D TR

 SRAM GX EAGLE 11-50T 12s

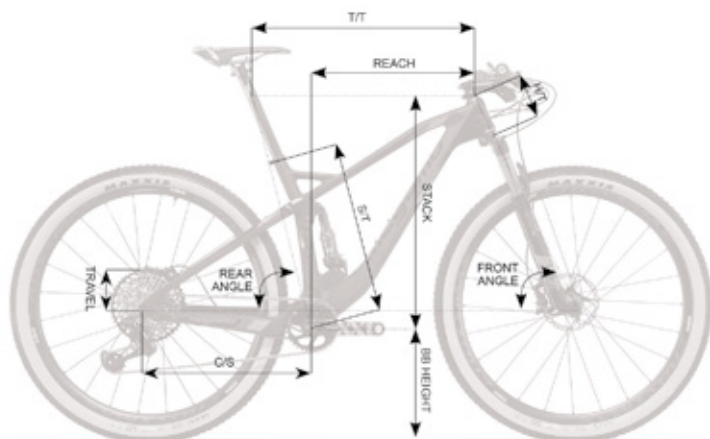

TRACK ELITE 05

	S	M	L	XL
SIZE	15,5"	17,5"	19"	21"
T/T	568	600	627	650
C/S	435	435	435	435
S/T	395	445	483	520
H/T	95	95	105	115
REACH	399	432	457	488
STACK	584	584	594	603
BB HEIGHT	308	308	308	308
FRONT ANGLE	69	69	69	69
REAR ANGLE	74	74	74	75

TRACK ELITE 05 GREEN



SPECIFICATIONS / ESPECIFICACIONES

 29 TRACK FS Full Carbon Construction FSC Technology BB92 Carbon Swingarm Boost 12x148mm Travel 100mm

 FOX 32 FACTORY STEPCAST KASHIMA FIT4 100 mm REMOTE LOCKOUT, 15x110 BOOST

 FOX FLOAT DPS FACTORY KASHIMA Remote Evol LV MEGAMO Custom Reb. Adj. Travel 100 Locjout 165x38mm

 FSA 1-1/8 1-1/2 * 1.5 TAPERED

 MEGAMO CARBON 710mm

 MEGAMO ADVANCED 17°

 MEGAMO FACTORY ELITE 31,6mm

 SELLE ITALIA X-LR TITANIUM RAIL

 SRAM GX EAGLE 12s

 SRAM STYLO 32 T 12 s

 SRAM GX EAGLE 12s

 SHIMANO XT 8000

 MAVIC CROSSMAX ELITE 15X110 BOOST / 12X148 BOOST

 MAVIC CROSSMAX ELITE 15X110 BOOST / 12X148 BOOST

 MAXXIS IKON 29X2,2 SKINWALL EXO 3D TR

 SRAM GX EAGLE 11-50T 12s

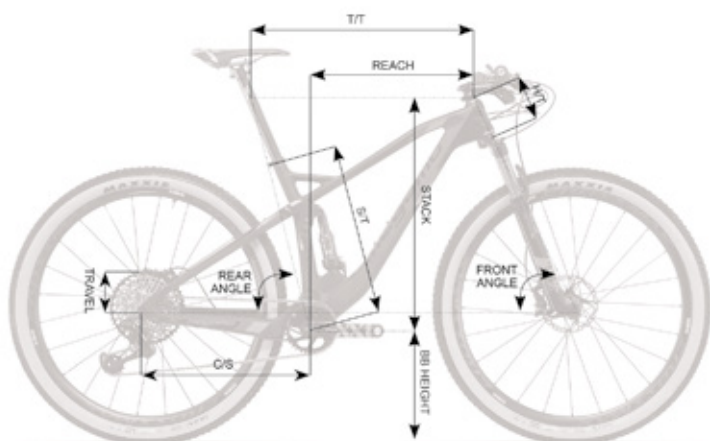

















TRACK ELITE 05

	S	M	L	XL
SIZE	15,5"	17,5"	19"	21"
T/T	568	600	627	650
C/S	435	435	435	435
S/T	395	445	483	520
H/T	95	95	105	115
REACH	399	432	457	488
STACK	584	584	594	603
BB HEIGHT	308	308	308	308
FRONT ANGLE	69	69	69	69
REAR ANGLE	74	74	74	75

TRACK ELITE 05 BLACK



SPECIFICATIONS / ESPECIFICACIONES

-  29 TRACK FS Full Carbon Construction FSC Technology BB92 Carbon Swingarm Boost 12x148mm Travel 100mm
-  FOX 32 FACTORY STEPCAST KASHIMA FIT4 100 mm REMOTE LOCKOUT, 15x110 BOOST
-  FOX FLOAT DPS FACTORY KASHIMA Remote Evol LV MEGAMO Custom Reb. Adj. Travel 100 Locjout 165x38mm
-  FSA 1-1/8 1-1/2 * 1.5 TAPERED
-  MEGAMO CARBON 710mm
-  MEGAMO ADVANCED 17°
-  MEGAMO FACTORY ELITE 31,6mm
-  SELLE ITALIA X-LR TITANIUM RAIL
-  SRAM GX EAGLE 12s
-  SRAM STYLO 32 T 12 s
-  SRAM GX EAGLE 12s
-  SHIMANO XT 8000
-  MAVIC CROSSMAX ELITE 15X110 BOOST / 12X148 BOOST
-  MAVIC CROSSMAX ELITE 15X110 BOOST / 12X148 BOOST
-  MAXXIS IKON 29X2,2 SKINWALL EXO 3D TR
-  SRAM GX EAGLE 11-50T 12s

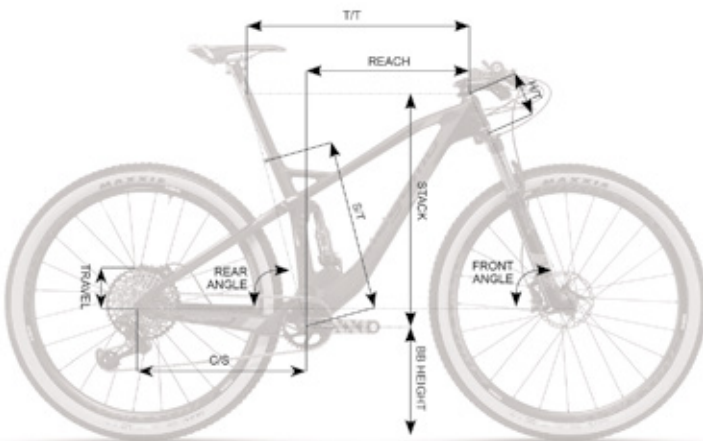

















TRACK ELITE 05

	S	M	L	XL
SIZE	15,5"	17,5"	19"	21"
T/T	568	600	627	650
C/S	435	435	435	435
S/T	395	445	483	520
H/T	95	95	105	115
REACH	399	432	457	488
STACK	584	584	594	603
BB HEIGHT	308	308	308	308
FRONT ANGLE	69	69	69	69
REAR ANGLE	74	74	74	75

TRACK 07 ORANGE



SPECIFICATIONS / ESPECIFICACIONES

 29 TRACK FS Full Carbon Construction FSC Technology BB92 Carbon Swingarm Boost 12x148mm Travel 100mm	 SELLE ITALIA X-LR
 FOX STEP CAST 32 PERFORMANCE, TRAVEL 100mm 15x110 BOOST + REMOTE LOCKOUT	 SRAM GX EAGLE 12s
 FOX FLOAT PERFORMANCE ELITE, REMOTE LOCKOUT, LV EVOL , TRAVEL 100mm / 165x68mm	 SRAM STYLO 32 T 12 s
 FSA 1-1/8 1-1/2 * 1.5 TAPERED	 SRAM GX EAGLE 12s
 MEGAMO FOV COMPACT	 SHIMANO MT500
 MEGAMO FOV COMPACT	 MAVIC CROSSMAX 15X110 BOOST / 12X148 BOOST
 MEGAMO 31,6mm	 MAVIC CROSSMAX 15X110 BOOST / 12X148 BOOST
	 MAXXIS IKON 29X2,2 SKINWALL EXO 3D TR
	 SRAM GX EAGLE 11-50T 12s

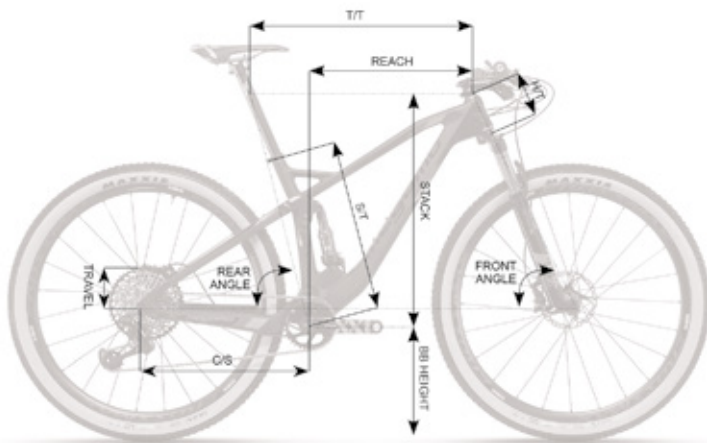

TRACK 07

	S	M	L	XL
SIZE	15,5"	17,5"	19"	21"
T/T	568	600	627	650
C/S	435	435	435	435
S/T	395	445	483	520
H/T	95	95	105	115
REACH	399	432	457	488
STACK	584	584	594	603
BB HEIGHT	308	308	308	308
FRONT ANGLE	69	69	69	69
REAR ANGLE	74	74	74	75

TRACK 07 GREEN

E-BIKES

MTB

ROAD

FAT

TREKKING















CITY

KIDS BMX

WEAR/ROPA



SPECIFICATIONS / ESPECIFICACIONES

-  29 TRACK FS Full Carbon Construction FSC Technology BB92 Carbon Swingarm Boost 12x148mm Travel 100mm
-  FOX STEP CAST 32 PERFORMANCE, TRAVEL 100mm 15x110 BOOST + REMOTE LOCKOUT
-  FOX FLOAT PERFORMANCE ELITE, REMOTE LOCKOUT, LV EVOL, TRAVEL 100mm / 165x68mm
-  FSA 1-1/8 1-1/2 * 1.5 TAPERED
-  MEGAMO FOV COMPACT
-  MEGAMO FOV COMPACT
-  MEGAMO 31,6mm
-  SELLE ITALIA X-LR
-  SRAM GX EAGLE 12s
-  SRAM STYLO 32 T 12 s
-  SRAM GX EAGLE 12s
-  SHIMANO MT500
-  MAVIC CROSSMAX 15X110 BOOST / 12X148 BOOST
-  MAVIC CROSSMAX 15X110 BOOST / 12X148 BOOST
-  MAXXIS IKON 29X2,2 SKINWALL EXO 3D TR
-  SRAM GX EAGLE 11-50T 12s

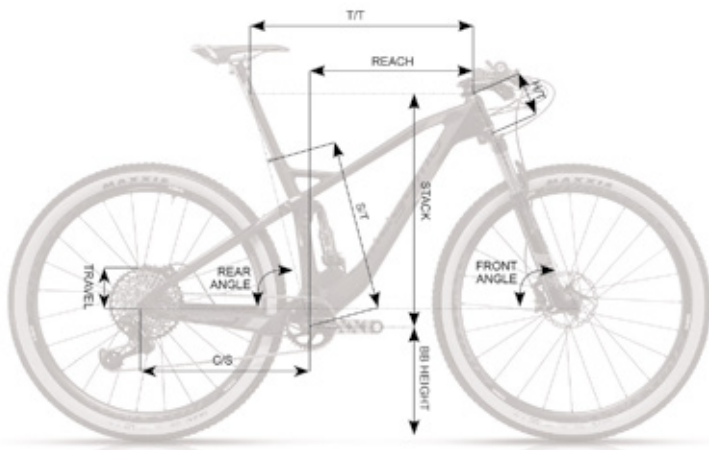

















TRACK 07

	S	M	L	XL
SIZE	15,5"	17,5"	19"	21"
T/T	568	600	627	650
C/S	435	435	435	435
S/T	395	445	483	520
H/T	95	95	105	115
REACH	399	432	457	488
STACK	584	584	594	603
BB HEIGHT	308	308	308	308
FRONT ANGLE	69	69	69	69
REAR ANGLE	74	74	74	75

TRACK 07 BLACK



SPECIFICATIONS / ESPECIFICACIONES

 29 TRACK FS Full Carbon Construction FSC Technology BB92 Carbon Swingarm Boost 12x148mm Travel 100mm	 SELLE ITALIA X-LR
 FOX STEP CAST 32 PERFORMANCE, TRAVEL 100mm 15x110 BOOST + REMOTE LOCKOUT	 SRAM GX EAGLE 12s
 FOX FLOAT PERFORMANCE ELITE, REMOTE LOCKOUT, LV EVOL , TRAVEL 100mm / 165x68mm	 SRAM STYLO 32 T 12 s
 FSA 1-1/8 1-1/2 * 1.5 TAPERED	 SRAM GX EAGLE 12s
 MEGAMO FOV COMPACT	 SHIMANO MT500
 MEGAMO FOV COMPACT	 MAVIC CROSSMAX 15X110 BOOST / 12X148 BOOST
 MEGAMO 31,6mm	 MAVIC CROSSMAX 15X110 BOOST / 12X148 BOOST
	 MAXXIS IKON 29X2,2 SKINWALL EXO 3D TR
	 SRAM GX EAGLE 11-50T 12s

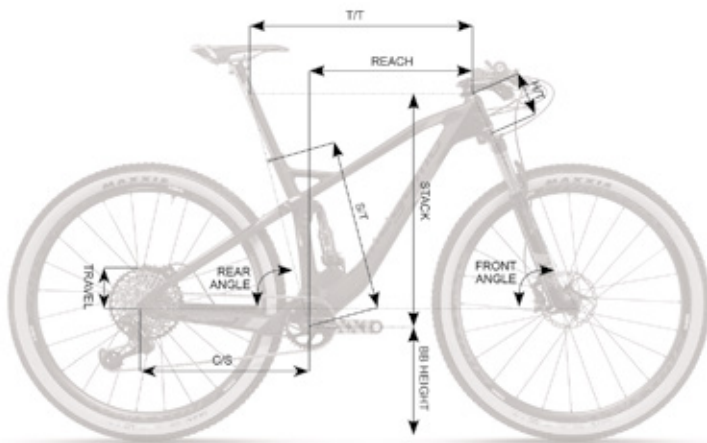

TRACK 07

	S	M	L	XL
SIZE	15,5"	17,5"	19"	21"
T/T	568	600	627	650
C/S	435	435	435	435
S/T	395	445	483	520
H/T	95	95	105	115
REACH	399	432	457	488
STACK	584	584	594	603
BB HEIGHT	308	308	308	308
FRONT ANGLE	69	69	69	69
REAR ANGLE	74	74	74	75

TRACK 10 ORANGE

E-BIKES

MTB

ROAD

FAT

TREKKING

















CITY

KIDS BMX

WEAR/ROPA



SPECIFICATIONS / ESPECIFICACIONES

-  29 TRACK FS Full Carbon Construction FSC Technology BB92 Carbon Swingarm Boost 12x148mm Travel 100mm
-  FOX RHYTHM 32, TRAVEL 100mm 15x110 BOOST + REMOTE LOCKOUT
-  FOX FLOAT PERFORMANCE ELITE, REMOTE LOCKOUT, LV EVOL., TRAVEL 100mm / 165x68mm
-  FSA 1-1/8 1-1/2 * 1.5 TAPERED
-  MEGAMO FOV COMPACT
-  MEGAMO FOV COMPACT
-  MEGAMO 31,6mm
-  SELLE ITALIA X3
-  SRAM NX EAGLE 12s
-  SRAM NX EAGLE 32T 12s
-  SRAM NX EAGLE 12s
-  SHIMANO M500
-  FORMULA ELITE 15X110 BOOST / 12X148 BOOST
-  SUNRINGLE INFERNO 25 15X110 BOOST / 12X148 BOOST
-  MAXXIS IKON 29X2,2 SKINWALL
-  SRAM NX EAGLE 11-50T 12s

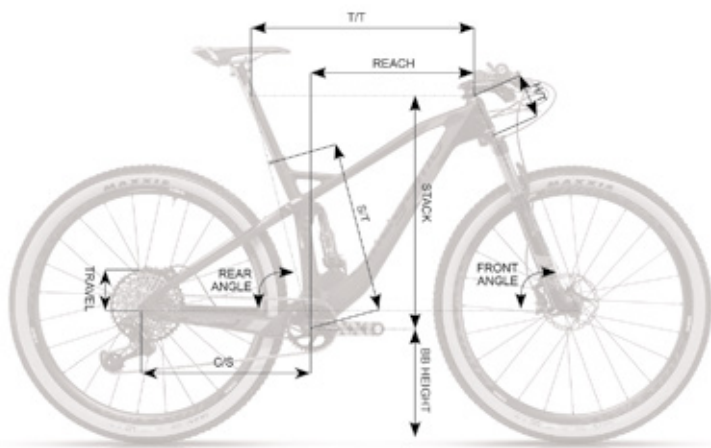

















TRACK 10

	S	M	L	XL
SIZE	15,5"	17,5"	19"	21"
T/T	568	600	627	650
C/S	435	435	435	435
S/T	395	445	483	520
H/T	95	95	105	115
REACH	399	432	457	488
STACK	584	584	594	603
BB HEIGHT	308	308	308	308
FRONT ANGLE	69	69	69	69
REAR ANGLE	74	74	74	75

TRACK 10 GREEN



SPECIFICATIONS / ESPECIFICACIONES

 29 TRACK FS Full Carbon Construction FSC Technology BB92 Carbon Swingarm Boost 12x148mm Travel 100mm	 SELLE ITALIA X3
 FOX RHYTHM 32, TRAVEL 100mm 15x110 BOOST + REMOTE LOCKOUT	 SRAM NX EAGLE 12s
 FOX FLOAT PERFORMANCE ELITE, REMOTE LOCKOUT, LV EVOL , TRAVEL 100mm / 165x68mm	 SRAM NX EAGLE 32T 12s
 FSA 1-1/8 1-1/2 * 1.5 TAPERED	 SRAM NX EAGLE 12s
 MEGAMO FOV COMPACT	 SHIMANO M500
 MEGAMO FOV COMPACT	 FORMULA ELITE 15X110 BOOST / 12X148 BOOST
 MEGAMO 31,6mm	 SUNRINGLE INFERNO 25 15X110 BOOST / 12X148 BOOST
	 MAXXIS IKON 29X2,2 SKINWALL
	 SRAM NX EAGLE 11-50T 12s

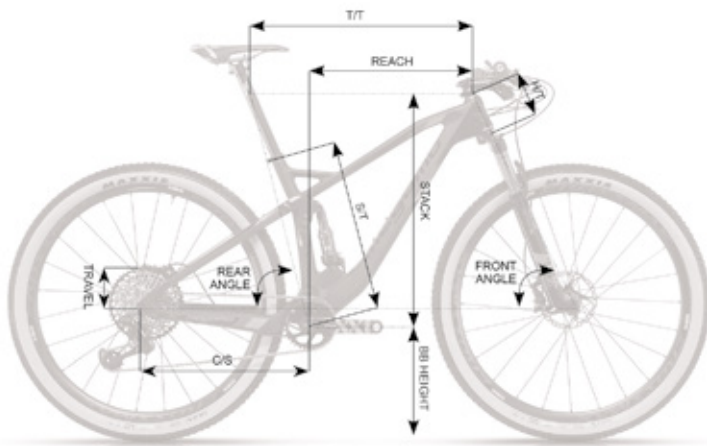

TRACK 10

	S	M	L	XL
SIZE	15,5"	17,5"	19"	21"
T/T	568	600	627	650
C/S	435	435	435	435
S/T	395	445	483	520
H/T	95	95	105	115
REACH	399	432	457	488
STACK	584	584	594	603
BB HEIGHT	308	308	308	308
FRONT ANGLE	69	69	69	69
REAR ANGLE	74	74	74	75

TRACK 10 BLACK

E-BIKES

MTB

ROAD

FAT

TREKKING







CITY

KIDS BMX

WEAR/ROPA



SPECIFICATIONS / ESPECIFICACIONES

-  29 TRACK FS Full Carbon Construction FSC Technology BB92 Carbon Swingarm Boost 12x148mm Travel 100mm
-  FOX RHYTHM 32, TRAVEL 100mm 15x110 BOOST + REMOTE LOCKOUT
-  FOX FLOAT PERFORMANCE ELITE, REMOTE LOCKOUT, LV EVOL., TRAVEL 100mm / 165x68mm
-  FSA 1-1/8 1-1/2 * 1.5 TAPERED
-  MEGAMO FOV COMPACT
-  MEGAMO FOV COMPACT
-  MEGAMO 31,6mm

-  SELLE ITALIA X3
-  SRAM NX EAGLE 12s
-  SRAM NX EAGLE 32T 12s
-  SRAM NX EAGLE 12s
-  SHIMANO M500
-  FORMULA ELITE 15X110 BOOST / 12X148 BOOST
-  SUNRINGLE INFERNO 25 15X110 BOOST / 12X148 BOOST
-  MAXXIS IKON 29X2,2 SKINWALL
-  SRAM NX EAGLE 11-50T 12s

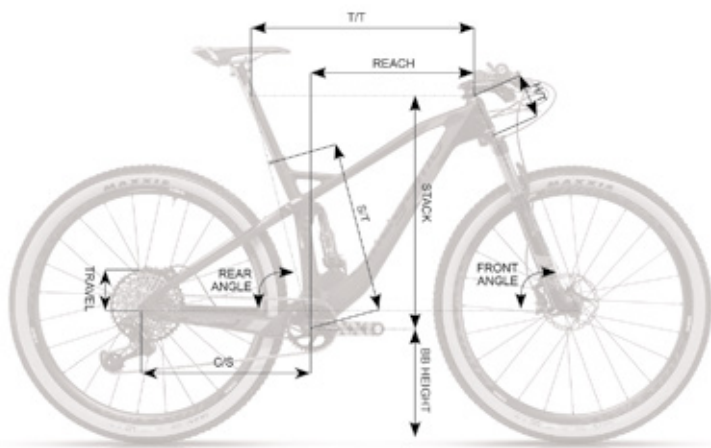

TRACK 10

	S	M	L	XL
SIZE	15,5"	17,5"	19"	21"
T/T	568	600	627	650
C/S	435	435	435	435
S/T	395	445	483	520
H/T	95	95	105	115
REACH	399	432	457	488
STACK	584	584	594	603
BB HEIGHT	308	308	308	308
FRONT ANGLE	69	69	69	69
REAR ANGLE	74	74	74	75





WEAR/ROPA

KIDS BMX

CITY

TREKKING

FAT

ROAD

MTB

E-BIKES

FACTORY



You will find no limits! Created to win! The monocoque frame developed with thinner and optimized tights is stiffer but lighter. It has all the technical characteristics that you expect.

No encontrarás límites! Diseñada para triunfar. El cuadro monocasco desarrollado con unas vainas estilizadas y optimizadas que garantizan rigidez y ligereza simultáneamente, cubre todas las expectativas técnicas.





STRUCTURAL CONSTRUCTION

Layering for each zone according to its effort and solicitation.

CONSTRUCCIÓN ESTRUCTURAL

Una tubería optimizada para cada zona según su esfuerzo y sollicitación.

ABSORTION AND RIGIDITY

Absence of union pieces in the seat area providing more comfortable races, with wider tires and seat post 30.9.

ABSORCIÓN Y RIGIDEZ

Ausencia de puente de unión en la zona del sillín, paso de rueda mayor y tija de 30.9.



GEOMETRY

Lower dimensions, greater steering control and a shorter rear with specific size measures.

GEOMETRÍA

Cotas más bajas, mayor control de la dirección y una parte trasera más corta con medidas específicas por tallas.



BOOST STANDARD

The rear axle Boost allows improving the chain line without losing rigidity.

BOOST STANDARD















El eje trasero Boost permite mejorar la línea de cadena sin perder rigidez.



FACTORY ELITE 03 EAGLE ORANGE



SPECIFICATIONS / ESPECIFICACIONES

 FACTORY CARBON ADVANCED FRAME, 12x148 BOOST, INTERNAL CABLE ROUTING, SUITABLE DI2	 SRAM XX1 EAGLE 12s
 FOX 32 FACTORY STEPCAST KASHIMA FIT4 100 mm REMOTE LOCKOUT, 15x110 BOOST	 SRAM XX1 EAGLE 12s
 FSA 1-1/8 1-1/2 * 1.5 TAPERED	 SRAM XX1 EAGLE 12s
 HPC 29er CARBON 176 gr	 SHIMANO XT-8000
 HPC COMP +-17° FOV	 MAVIC CROSSMAX ELITE CARBON 15X110 BOOST / 12X148 BOOST
 HPC PRO 31,6 x 410	 MAVIC CROSSMAX ELITE CARBON 15X110 BOOST / 12X148 BOOST
 SELLE ITALIA X-LR TITANIUM RAIL	 MAXXIS IKON 29X2,2 SKINWALL EXO 3D TR
	 SRAM XX1 EAGLE 12s 10-50T

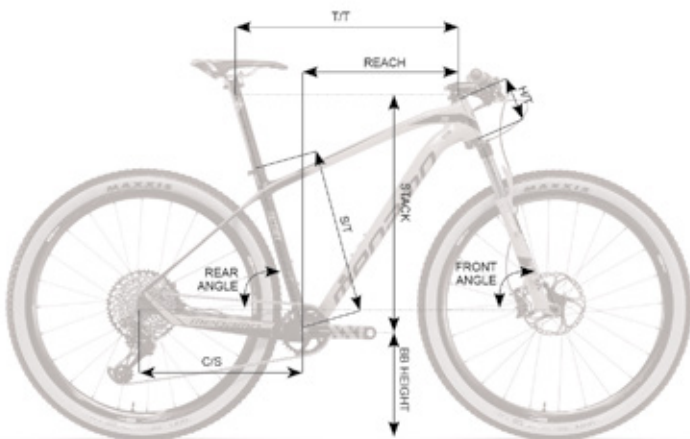

FACTORY ELITE 03 EAGLE







29"

	S	M	L	XL
SIZE	16"	17,5"	19"	21"
T/T	575	595	620	645
C/S	445	445	445	445
S/T	409	447	489	530
H/T	102	107	117	132
REACH	384	404	429	454
STACK	624	626	638	652
BB HEIGHT	308	308	308	308
FRONT ANGLE	71	71	71	71
REAR ANGLE	74	74	74	74

FACTORY ELITE 03 EAGLE GREEN



SPECIFICATIONS / ESPECIFICACIONES

-  FACTORY CARBON ADVANCED FRAME, 12x148 BOOST, INTERNAL CABLE ROUTING, SUITABLE Di2
-  FOX 32 FACTORY STEPCAST KASHIMA FIT4 100 mm REMOTE LOCKOUT, 15x110 BOOST
-  FSA 1-1/8 1-1/2 * 1.5 TAPERED
-  HPC 29er CARBON 176 gr
-  HPC COMP +-17° FOV
-  HPC PRO 31,6 x 410
-  SELLE ITALIA X-LR TITANIUM RAIL

-  SRAM XX1 EAGLE 12s
-  SRAM XX1 EAGLE 12s
-  SRAM XX1 EAGLE 12s
-  SHIMANO XT-8000
-  MAVIC CROSSMAX ELITE CARBON 15X110 BOOST / 12X148 BOOST
-  MAVIC CROSSMAX ELITE CARBON 15X110 BOOST / 12X148 BOOST
-  MAXXIS IKON 29X2,2 SKINWALL EXO 3D TR
-  SRAM XX1 EAGLE 12s 10-50T

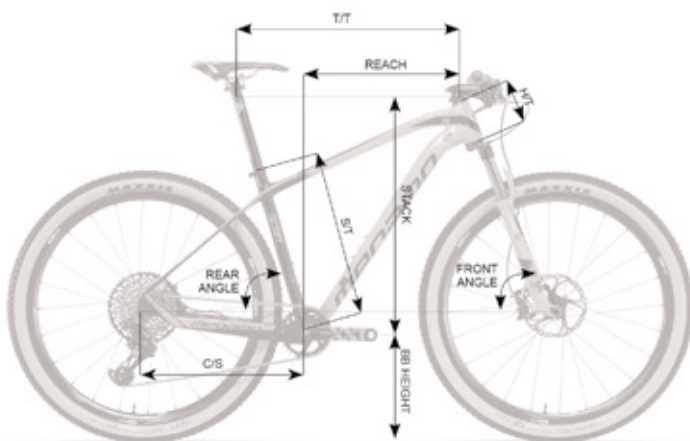

FACTORY ELITE 03 EAGLE















29"

	S	M	L	XL
SIZE	16"	17,5"	19"	21"
T/T	575	595	620	645
C/S	445	445	445	445
S/T	409	447	489	530
H/T	102	107	117	132
REACH	384	404	429	454
STACK	624	626	638	652
BB HEIGHT	308	308	308	308
FRONT ANGLE	71	71	71	71
REAR ANGLE	74	74	74	74

FACTORY ELITE 03 EAGLE BLACK



SPECIFICATIONS / ESPECIFICACIONES

 FACTORY CARBON ADVANCED FRAME, 12x148 BOOST, INTERNAL CABLE ROUTING, SUITABLE DI2	 SRAM XX1 EAGLE 12s
 FOX 32 FACTORY STEPCAST KASHIMA FIT4 100 mm REMOTE LOCKOUT, 15x110 BOOST	 SRAM XX1 EAGLE 12s
 FSA 1-1/8 1-1/2 * 1.5 TAPERED	 SRAM XX1 EAGLE 12s
 HPC 29er CARBON 176 gr	 SHIMANO XT-8000
 HPC COMP +-17° FOV	 MAVIC CROSSMAX ELITE CARBON 15X110 BOOST / 12X148 BOOST
 HPC PRO 31,6 x 410	 MAVIC CROSSMAX ELITE CARBON 15X110 BOOST / 12X148 BOOST
 SELLE ITALIA X-LR TITANIUM RAIL	 MAXXIS IKON 29X2,2 SKINWALL EXO 3D TR
	 SRAM XX1 EAGLE 12s 10-50T

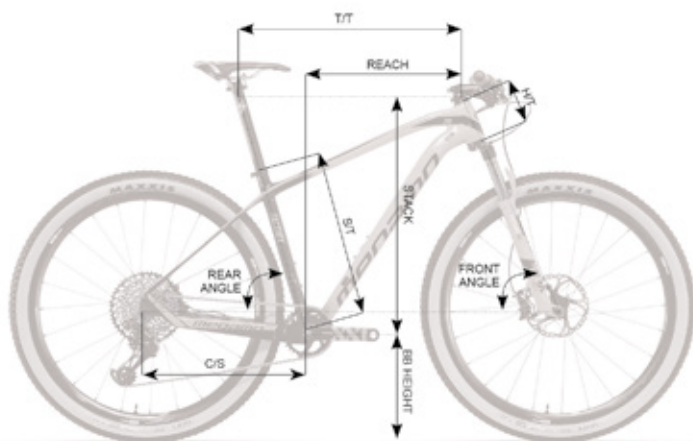

FACTORY ELITE 03 EAGLE

29"

	S	M	L	XL
SIZE	16"	17,5"	19"	21"
T/T	575	595	620	645
C/S	445	445	445	445
S/T	409	447	489	530
H/T	102	107	117	132
REACH	384	404	429	454
STACK	624	626	638	652
BB HEIGHT	308	308	308	308
FRONT ANGLE	71	71	71	71
REAR ANGLE	74	74	74	74

FACTORY ELITE 05 EAGLE ORANGE

E-BIKES

MTB

ROAD

FAT

TREKKING







CITY

KIDS BMX

WEAR/ROPA



SPECIFICATIONS / ESPECIFICACIONES

-  FACTORY CARBON ADVANCED FRAME, 12x148 BOOST, INTERNAL CABLE ROUTING, SUITABLE Di2
-  FOX 32 FACTORY STEPCAST KASHIMA FIT4 100 mm REMOTE LOCKOUT, 15x110 BOOST
-  FSA 1-1/8 1-1/2 * 1.5 TAPERED
-  HPC 29er CARBON 176 gr
-  HPC COMP +-17° FOV
-  HPC PRO 31,6 x 410
-  SELLE ITALIA X-LR TITANIUM RAIL

-  SRAM GX EAGLE 12s
-  SRAM STYLO EAGLE 32T 12s
-  SRAM GX EAGLE 12s
-  SHIMANO XT-8000
-  MAVIC CROSSMAX ELITE 15x110 BOOST / 12x148 BOOST
-  MAVIC CROSSMAX ELITE 15x110 BOOST / 12x148 BOOST
-  MAXXIS IKON 29x2,2 SKINWALL
-  SRAM GX EAGLE 12s 10-50T

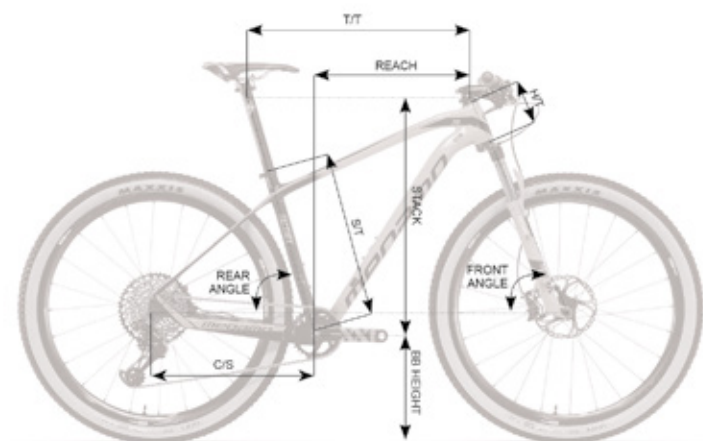

FACTORY ELITE 05 EAGLE







29"

	S	M	L	XL
SIZE	16"	17,5"	19"	21"
T/T	575	595	620	645
C/S	445	445	445	445
S/T	409	447	489	530
H/T	102	107	117	132
REACH	384	404	429	454
STACK	624	626	638	652
BB HEIGHT	308	308	308	308
FRONT ANGLE	71	71	71	71
REAR ANGLE	74	74	74	74

FACTORY ELITE 05 EAGLE GREEN



SPECIFICATIONS / ESPECIFICACIONES

-  FACTORY CARBON ADVANCED FRAME, 12x148 BOOST, INTERNAL CABLE ROUTING, SUITABLE Di2
-  FOX 32 FACTORY STEPCAST KASHIMA FIT4 100 mm REMOTE LOCKOUT, 15x110 BOOST
-  FSA 1-1/8 1-1/2 * 1.5 TAPERED
-  HPC 29er CARBON 176 gr
-  HPC COMP +-17° FOV
-  HPC PRO 31,6 x 410
-  SELLE ITALIA X-LR TITANIUM RAIL

-  SRAM GX EAGLE 12s
-  SRAM STYLO EAGLE 32T 12s
-  SRAM GX EAGLE 12s
-  SHIMANO XT-8000
-  MAVIC CROSSMAX ELITE 15X110 BOOST / 12X148 BOOST
-  MAVIC CROSSMAX ELITE 15X110 BOOST / 12X148 BOOST
-  MAXXIS IKON 29X2,2 SKINWALL
-  SRAM GX EAGLE 12s 10-50T

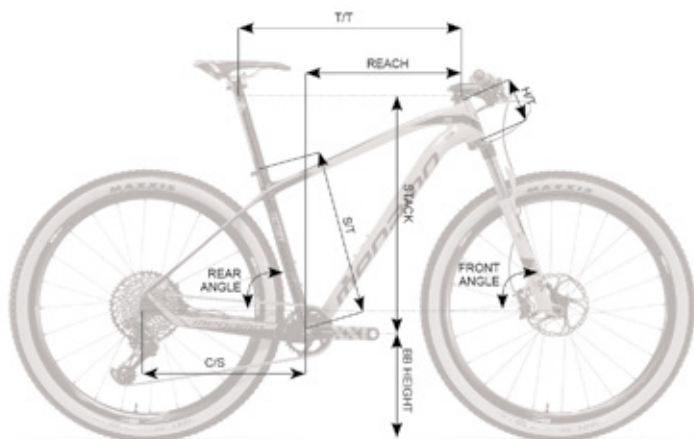

FACTORY ELITE 05 EAGLE

29"

	S	M	L	XL
SIZE	16"	17,5"	19"	21"
T/T	575	595	620	645
C/S	445	445	445	445
S/T	409	447	489	530
H/T	102	107	117	132
REACH	384	404	429	454
STACK	624	626	638	652
BB HEIGHT	308	308	308	308
FRONT ANGLE	71	71	71	71
REAR ANGLE	74	74	74	74

FACTORY ELITE 05 EAGLE BLACK

E-BIKES

MTB

ROAD

FAT

TREKKING







CITY

KIDS BMX

WEAR/ROPA



SPECIFICATIONS / ESPECIFICACIONES

-  FACTORY CARBON ADVANCED FRAME, 12x148 BOOST, INTERNAL CABLE ROUTING, SUITABLE Di2
-  FOX 32 FACTORY STEPCAST KASHIMA FIT4 100 mm REMOTE LOCKOUT, 15x110 BOOST
-  FSA 1-1/8 1-1/2 * 1.5 TAPERED
-  HPC 29er CARBON 176 gr
-  HPC COMP +-17° FOV
-  HPC PRO 31,6 x 410
-  SELLE ITALIA X-LR TITANIUM RAIL

-  SRAM GX EAGLE 12s
-  SRAM STYLO EAGLE 32T 12s
-  SRAM GX EAGLE 12s
-  SHIMANO XT-8000
-  MAVIC CROSSMAX ELITE 15x110 BOOST / 12x148 BOOST
-  MAVIC CROSSMAX ELITE 15x110 BOOST / 12x148 BOOST
-  MAXXIS IKON 29x2,2 SKINWALL
-  SRAM GX EAGLE 12s 10-50T

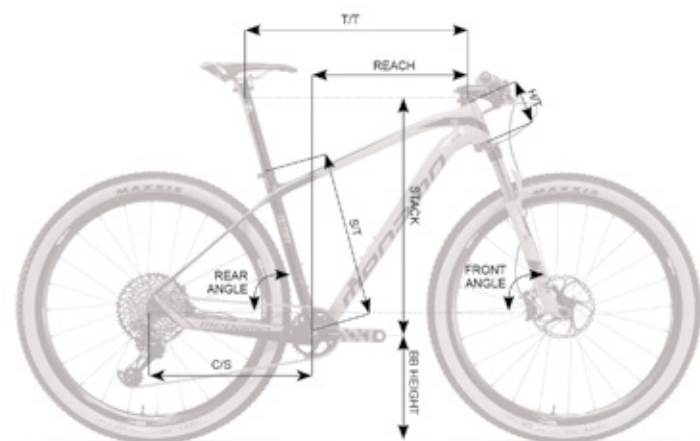

FACTORY ELITE 05 EAGLE















29"

	S	M	L	XL
SIZE	16"	17,5"	19"	21"
T/T	575	595	620	645
C/S	445	445	445	445
S/T	409	447	489	530
H/T	102	107	117	132
REACH	384	404	429	454
STACK	624	626	638	652
BB HEIGHT	308	308	308	308
FRONT ANGLE	71	71	71	71
REAR ANGLE	74	74	74	74

FACTORY 07 EAGLE ORANGE



SPECIFICATIONS / ESPECIFICACIONES

 FACTORY CARBON ADVANCED FRAME, 12x148 BOOST, INTERNAL CABLE ROUTING, SUITABLE Di2	 SRAM GX EAGLE 12s
 FOX STEP CAST 32 PERFORMANCE, TRAVEL 100mm 15x110 BOOST + REMOTE LOCKOUT	 SRAM STYLO EAGLE 32T 12s
 FSA 1-1/8 1-1/2 * 1.5 TAPERED	 SRAM GX EAGLE 12s
 MEGAMO FOV COMPACT	 SHIMANO MT-500 HYDRAULIC DISC
 MEGAMO FOV COMPACT	 MAVIC CROSSMAX 15X110 BOOST / 12X148 BOOST
 MEGAMO 30,9mm	 MAVIC CROSSMAX 15X110 BOOST / 12X148 BOOST
 SELLE ITALIA X3	 MAXXIS IKON 29x2,2
	 SRAM GX EAGLE 12s 10-50T

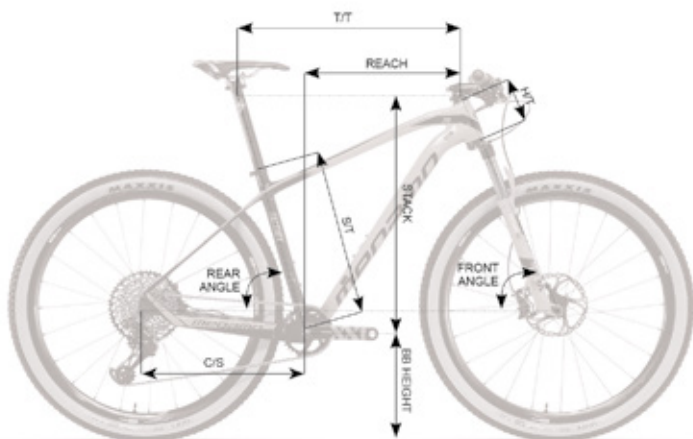















FACTORY 07 EAGLE

	S	M	L	XL
SIZE	16"	17,5"	19"	21"
T/T	575	595	620	645
C/S	445	445	445	445
S/T	409	447	489	530
H/T	102	107	117	132
REACH	384	404	429	454
STACK	624	626	638	652
BB HEIGHT	308	308	308	308
FRONT ANGLE	71	71	71	71
REAR ANGLE	74	74	74	74

FACTORY 07 EAGLE GREEN



SPECIFICATIONS / ESPECIFICACIONES

-  FACTORY CARBON ADVANCED FRAME, 12x148 BOOST, INTERNAL CABLE ROUTING, SUITABLE Di2
-  FOX STEP CAST 32 PERFORMANCE, TRAVEL 100mm 15x110 BOOST + REMOTE LOCKOUT
-  FSA 1-1/8 1-1/2 * 1.5 TAPERED
-  MEGAMO FOV COMPACT
-  MEGAMO FOV COMPACT
-  MEGAMO 30,9mm
-  SELLE ITALIA X3
-  SRAM GX EAGLE 12s
-  SRAM STYLO EAGLE 32T 12s
-  SRAM GX EAGLE 12s
-  SHIMANO MT-500 HYDRAULIC DISC
-  MAVIC CROSSMAX 15X110 BOOST / 12X148 BOOST
-  MAVIC CROSSMAX 15X110 BOOST / 12X148 BOOST
-  MAXXIS IKON 29x2,2
-  SRAM GX EAGLE 12s 10-50T

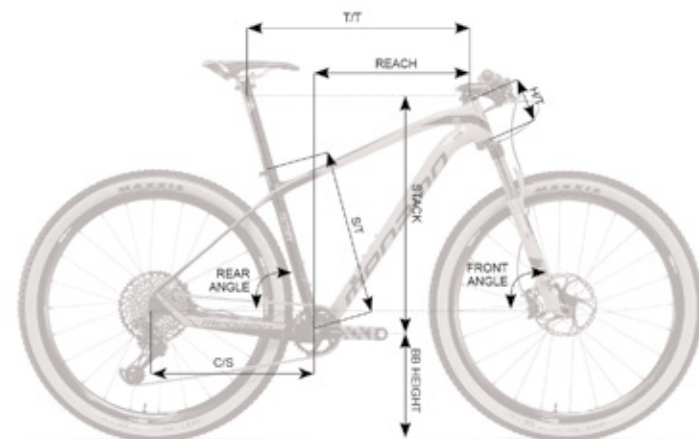















FACTORY 07 EAGLE

	S	M	L	XL
SIZE	16"	17,5"	19"	21"
T/T	575	595	620	645
C/S	445	445	445	445
S/T	409	447	489	530
H/T	102	107	117	132
REACH	384	404	429	454
STACK	624	626	638	652
BB HEIGHT	308	308	308	308
FRONT ANGLE	71	71	71	71
REAR ANGLE	74	74	74	74

FACTORY 07 EAGLE BLACK



SPECIFICATIONS / ESPECIFICACIONES

 FACTORY CARBON ADVANCED FRAME, 12x148 BOOST, INTERNAL CABLE ROUTING, SUITABLE Di2	 SRAM GX EAGLE 12s
 FOX STEP CAST 32 PERFORMANCE, TRAVEL 100mm 15x110 BOOST + REMOTE LOCKOUT	 SRAM STYLO EAGLE 32T 12s
 FSA 1-1/8 1-1/2 * 1.5 TAPERED	 SRAM GX EAGLE 12s
 MEGAMO FOV COMPACT	 SHIMANO MT-500 HYDRAULIC DISC
 MEGAMO FOV COMPACT	 MAVIC CROSSMAX 15X110 BOOST / 12X148 BOOST
 MEGAMO 30,9mm	 MAVIC CROSSMAX 15X110 BOOST / 12X148 BOOST
 SELLE ITALIA X3	 MAXXIS IKON 29x2,2
	 SRAM GX EAGLE 12s 10-50T

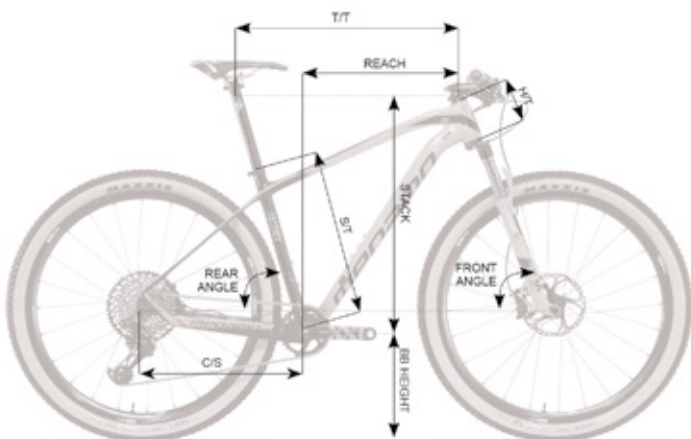















FACTORY 07 EAGLE

	S	M	L	XL
SIZE	16"	17,5"	19"	21"
T/T	575	595	620	645
C/S	445	445	445	445
S/T	409	447	489	530
H/T	102	107	117	132
REACH	384	404	429	454
STACK	624	626	638	652
BB HEIGHT	308	308	308	308
FRONT ANGLE	71	71	71	71
REAR ANGLE	74	74	74	74

FACTORY 15 EAGLE ORANGE



SPECIFICATIONS / ESPECIFICACIONES

-  FACTORY CARBO N ADVANCED FRAME, 12x148 BOOST, INTERNAL CABLE ROUTING, SUITABLE Di2
-  FOX RHYTHM 32, TRAVEL 100mm 15x110 BOOST + REMOTE LOCKOUT
-  FSA 1-1/8 1-1/2 * 1.5 TAPERED
-  MEGAMO FOV COMPACT
-  MEGAMO FOV COMPACT
-  MEGAMO 30,9mm
-  SELLE ITALIA X3
-  SRAM NX EAGLE 12s
-  SRAM NX EAGLE 32T 12s
-  SRAM NX EAGLE 12s
-  SHIMANO MT500 HYDRAULIC DISC
-  FORMULA ELITE 15x110 BOOST / 12x148 BOOST
-  SUNRINGLE INFERNO 25 15x110 BOOST / 12x148 BOOST
-  MAXXIS IKON 29x2,2 SKINWALL
-  SRAM NX EAGLE 12s 10-50T

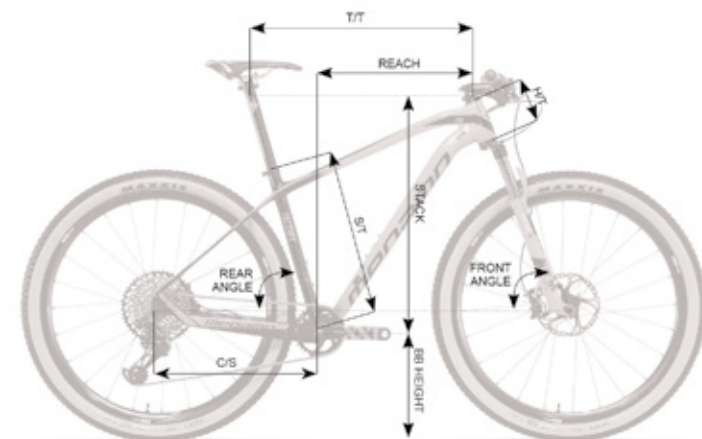







FACTORY 15 EAGLE









	S	M	L	XL
SIZE	16"	17,5"	19"	21"
T/T	575	595	620	645
C/S	445	445	445	445
S/T	409	447	489	530
H/T	102	107	117	132
REACH	384	404	429	454
STACK	624	626	638	652
BB HEIGHT	308	308	308	308
FRONT ANGLE	71	71	71	71
REAR ANGLE	74	74	74	74

FACTORY 15 EAGLE GREEN



SPECIFICATIONS / ESPECIFICACIONES

-  FACTORY CARBON ADVANCED FRAME, 12x148 BOOST, INTERNAL CABLE ROUTING, SUITABLE DI2
-  FOX RHYTHM 32, TRAVEL 100mm 15x110 BOOST + REMOTE LOCKOUT
-  FSA 1-1/8 1-1/2 * 1.5 TAPERED
-  MEGAMO FOV COMPACT
-  MEGAMO FOV COMPACT
-  MEGAMO 30,9mm
-  SELLE ITALIA X3

-  SRAM NX EAGLE 12s
-  SRAM NX EAGLE 32T 12s
-  SRAM NX EAGLE 12s
-  SHIMANO MT500 HYDRAULIC DISC
-  FORMULA ELITE 15x110 BOOST / 12x148 BOOST
-  SUNRINGLE INFERNO 25 15x110 BOOST / 12x148 BOOST
-  MAXXIS IKON 29x2,2 SKINWALL
-  SRAM NX EAGLE 12s 10-50T

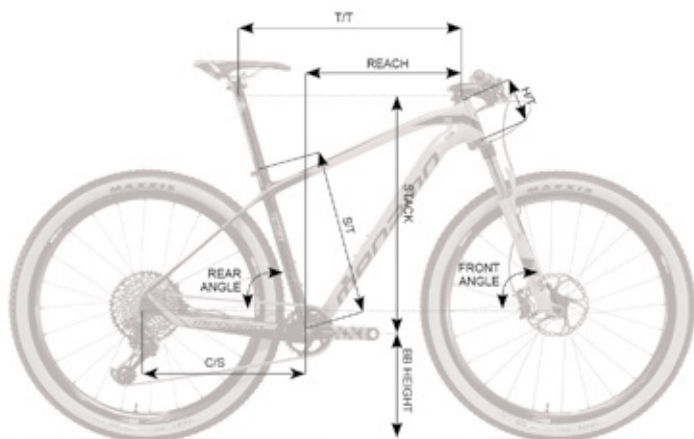







FACTORY 15 EAGLE

	S	M	L	XL
SIZE	16"	17,5"	19"	21"
T/T	575	595	620	645
C/S	445	445	445	445
S/T	409	447	489	530
H/T	102	107	117	132
REACH	384	404	429	454
STACK	624	626	638	652
BB HEIGHT	308	308	308	308
FRONT ANGLE	71	71	71	71
REAR ANGLE	74	74	74	74

FACTORY 15 EAGLE BLACK



SPECIFICATIONS / ESPECIFICACIONES

-  FACTORY CARBO N ADVANCED FRAME, 12x148 BOOST, INTERNAL CABLE ROUTING, SUITABLE Di2
-  FOX RHYTHM 32, TRAVEL 100mm 15x110 BOOST + REMOTE LOCKOUT
-  FSA 1-1/8 1-1/2 * 1.5 TAPERED
-  MEGAMO FOV COMPACT
-  MEGAMO FOV COMPACT
-  MEGAMO 30,9mm
-  SELLE ITALIA X3

-  SRAM NX EAGLE 12s
-  SRAM NX EAGLE 32T 12s
-  SRAM NX EAGLE 12s
-  SHIMANO MT500 HYDRAULIC DISC
-  FORMULA ELITE 15x110 BOOST / 12x148 BOOST
-  SUNRINGLE INFERNO 25 15x110 BOOST / 12x148 BOOST
-  MAXXIS IKON 29x2,2 SKINWALL
-  SRAM NX EAGLE 12s 10-50T

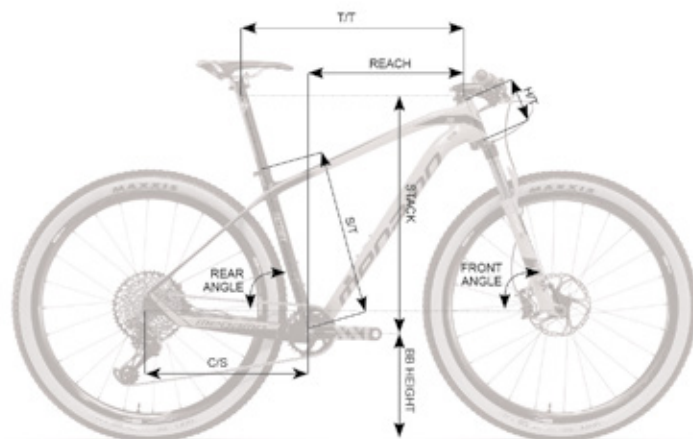









FACTORY 15 EAGLE









	S	M	L	XL
SIZE	16"	17,5"	19"	21"
T/T	575	595	620	645
C/S	445	445	445	445
S/T	409	447	489	530
H/T	102	107	117	132
REACH	384	404	429	454
STACK	624	626	638	652
BB HEIGHT	308	308	308	308
FRONT ANGLE	71	71	71	71
REAR ANGLE	74	74	74	74

FACTORY 20 ORANGE



SPECIFICATIONS / ESPECIFICACIONES

-  FACTORY CARBON ADVANCED FRAME, 12x148 BOOST, INTERNAL CABLE ROUTING, SUITABLE Di2
-  FOX RHYTHM 32, TRAVEL 100mm 15x110 BOOST + REMOTE LOCKOUT
-  FSA 1-1/8 1-1/2 * 1.5 TAPERED
-  MEGAMO FOV COMPACT
-  MEGAMO FOV COMPACT
-  MEGAMO 30,9mm
-  SELLE ITALIA X3
-  SHIMANO XT 8000 11s

-  SHIMANO XT 8000 11s
-  SHIMANO XT 8000 32T 1x11 /// 36-26T 2x11s
-  SHIMANO XT 8000 11s
-  SHIMANO XT 8000
-  MAVIC CROSSMAX 15X110 BOOST / 12X148 BOOST
-  MAVIC CROSSMAX 15X110 BOOST / 12X148 BOOST
-  MAXXIS IKON 29x2,2 SKINWALL
-  SHIMANO XT 8000 11-46T 11s

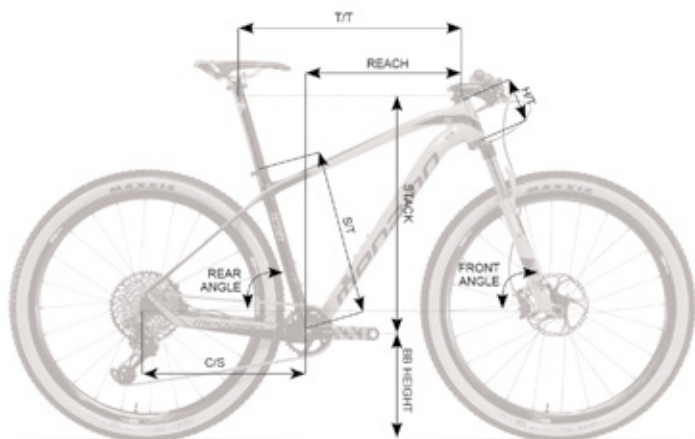

















FACTORY 20

	S	M	L	XL
SIZE	16"	17,5"	19"	21"
T/T	575	595	620	645
C/S	445	445	445	445
S/T	409	447	489	530
H/T	102	107	117	132
REACH	384	404	429	454
STACK	624	626	638	652
BB HEIGHT	308	308	308	308
FRONT ANGLE	71	71	71	71
REAR ANGLE	74	74	74	74



SPECIFICATIONS / ESPECIFICACIONES

-  FACTORY CARBON ADVANCED FRAME, 12x148 BOOST, INTERNAL CABLE ROUTING, SUITABLE Di2
-  FOX RHYTHM 32, TRAVEL 100mm 15x110 BOOST + REMOTE LOCKOUT
-  FSA 1-1/8 1-1/2 * 1.5 TAPERED
-  MEGAMO FOV COMPACT
-  MEGAMO FOV COMPACT
-  MEGAMO 30,9mm
-  SELLE ITALIA X3
-  SHIMANO XT 8000 11s

-  SHIMANO XT 8000 11s
-  SHIMANO XT 8000 32T 1x11 // 36-26T 2x11s
-  SHIMANO XT 8000 11s
-  SHIMANO XT 8000
-  MAVIC CROSSMAX 15X110 BOOST / 12X148 BOOST
-  MAVIC CROSSMAX 15X110 BOOST / 12X148 BOOST
-  MAXXIS IKON 29x2,2 SKINWALL
-  SHIMANO XT 8000 11-46T 11s

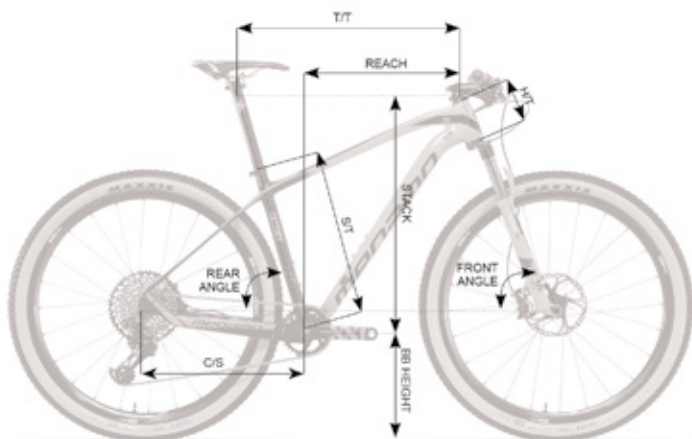









FACTORY 20









	S	M	L	XL
SIZE	16"	17,5"	19"	21"
T/T	575	595	620	645
C/S	445	445	445	445
S/T	409	447	489	530
H/T	102	107	117	132
REACH	384	404	429	454
STACK	624	626	638	652
BB HEIGHT	308	308	308	308
FRONT ANGLE	71	71	71	71
REAR ANGLE	74	74	74	74

FACTORY 20 BLACK



SPECIFICATIONS / ESPECIFICACIONES

-  FACTORY CARBON ADVANCED FRAME, 12x148 BOOST, INTERNAL CABLE ROUTING, SUITABLE Di2
-  FOX RHYTHM 32, TRAVEL 100mm 15x110 BOOST + REMOTE LOCKOUT
-  FSA 1-1/8 1-1/2 * 1.5 TAPERED
-  MEGAMO FOV COMPACT
-  MEGAMO FOV COMPACT
-  MEGAMO 30,9mm
-  SELLE ITALIA X3
-  SHIMANO XT 8000 11s

-  SHIMANO XT 8000 11s
-  SHIMANO XT 8000 32T 1x11 /// 36-26T 2x11s
-  SHIMANO XT 8000 11s
-  SHIMANO XT 8000
-  MAVIC CROSSMAX 15X110 BOOST / 12X148 BOOST
-  MAVIC CROSSMAX 15X110 BOOST / 12X148 BOOST
-  MAXXIS IKON 29x2,2 SKINWALL
-  SHIMANO XT 8000 11-46T 11s

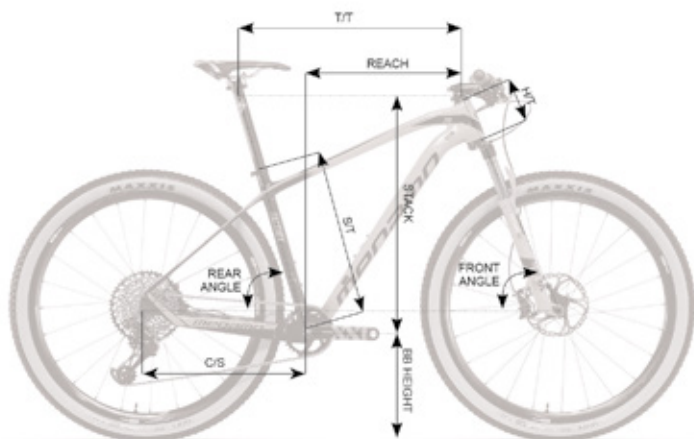







FACTORY 20

	S	M	L	XL
SIZE	16"	17,5"	19"	21"
T/T	575	595	620	645
C/S	445	445	445	445
S/T	409	447	489	530
H/T	102	107	117	132
REACH	384	404	429	454
STACK	624	626	638	652
BB HEIGHT	308	308	308	308
FRONT ANGLE	71	71	71	71
REAR ANGLE	74	74	74	74

FACTORY 30 EAGLE ORANGE



SPECIFICATIONS / ESPECIFICACIONES

-  FACTORY CARBON ADVANCED FRAME, 12x148 BOOST, INTERNAL CABLE ROUTING, SUITABLE Di2
-  ROCK SHOX JUDY SILVER, REMOTE 29" BOOST 15x110MM SOLO AIR 100MM BLACK UPPERS, TAPERED
-  FSA 1-1/8 1-1/2 * 1.5 TAPERED
-  MEGAMO FOV COMPACT
-  MEGAMO FOV COMPACT
-  MEGAMO 30,9mm
-  SELLE ITALIA X3

-  SRAM NX EAGLE 12s
-  SRAM NX EAGLE 32T 12s
-  SRAM NX EAGLE 12s
-  SHIMANO MT500 HYDRAULIC DISC
-  FORMULA ELITE 15x110 BOOST / 12x148 BOOST
-  SUNRINGLE INFERNO 25 15x110 BOOST / 12x148 BOOST
-  MAXXIS IKON 29x2,2 SKINWALL
-  SRAM NX EAGLE 12s 10-50T

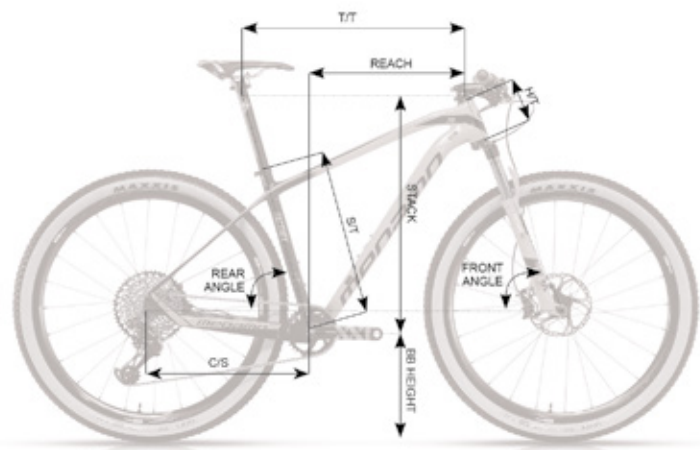

FACTORY 30 EAGLE

	S	M	L	XL
SIZE	16"	17,5"	19"	21"
T/T	575	595	620	645
C/S	445	445	445	445
S/T	409	447	489	530
H/T	102	107	117	132
REACH	384	404	429	454
STACK	624	626	638	652
BB HEIGHT	308	308	308	308
FRONT ANGLE	71	71	71	71
REAR ANGLE	74	74	74	74

FACTORY 30 EAGLE GREEN



SPECIFICATIONS / ESPECIFICACIONES

 FACTORY CARBON ADVANCED FRAME, 12x148 BOOST, INTERNAL CABLE ROUTING, SUITABLE Di2

 ROCK SHOX JUDY SILVER, REMOTE 29" BOOST 15x110MM SOLO AIR 100MM BLACK UPPERS, TAPERED

 FSA 1-1/8 1-1/2 * 1.5 TAPERED

 MEGAMO FOV COMPACT

 MEGAMO FOV COMPACT

 MEGAMO 30,9mm

 SELLE ITALIA X3

 SRAM NX EAGLE 12s

 SRAM NX EAGLE 32T 12s

 SRAM NX EAGLE 12s

 SHIMANO MT500 HYDRAULIC DISC

 FORMULA ELITE 15x110 BOOST / 12x148 BOOST

 SUNRINGLE INFERNO 25 15x110 BOOST / 12x148 BOOST

 MAXXIS IKON 29x2,2 SKINWALL

 SRAM NX EAGLE 12s 10-50T

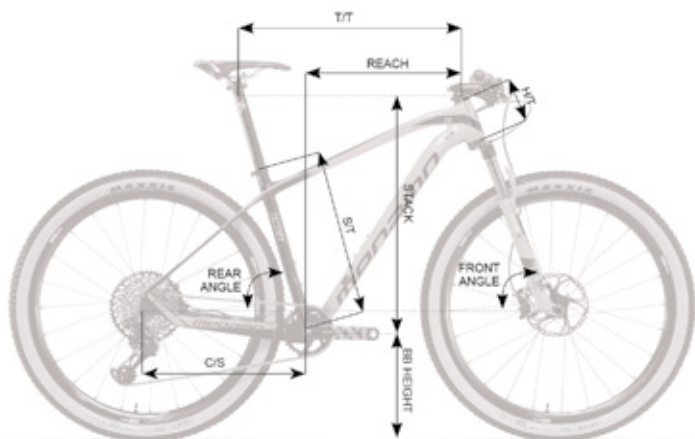







FACTORY 30 EAGLE

	S	M	L	XL
SIZE	16"	17,5"	19"	21"
T/T	575	595	620	645
C/S	445	445	445	445
S/T	409	447	489	530
H/T	102	107	117	132
REACH	384	404	429	454
STACK	624	626	638	652
BB HEIGHT	308	308	308	308
FRONT ANGLE	71	71	71	71
REAR ANGLE	74	74	74	74

FACTORY 30 EAGLE BLACK



SPECIFICATIONS / ESPECIFICACIONES

-  FACTORY CARBON ADVANCED FRAME, 12x148 BOOST, INTERNAL CABLE ROUTING, SUITABLE Di2
-  ROCK SHOX JUDY SILVER, REMOTE 29" BOOST 15X110MM SOLO AIR 100MM BLACK UPPERS, TAPERED
-  FSA 1-1/8 1-1/2 * 1.5 TAPERED
-  MEGAMO FOV COMPACT
-  MEGAMO FOV COMPACT
-  MEGAMO 30,9mm
-  SELLE ITALIA X3

-  SRAM NX EAGLE 12s
-  SRAM NX EAGLE 32T 12s
-  SRAM NX EAGLE 12s
-  SHIMANO MT500 HYDRAULIC DISC
-  FORMULA ELITE 15x110 BOOST / 12x148 BOOST
-  SUNRINGLE INFERNO 25 15x110 BOOST / 12x148 BOOST
-  MAXXIS IKON 29x2,2 SKINWALL
-  SRAM NX EAGLE 12s 10-50T

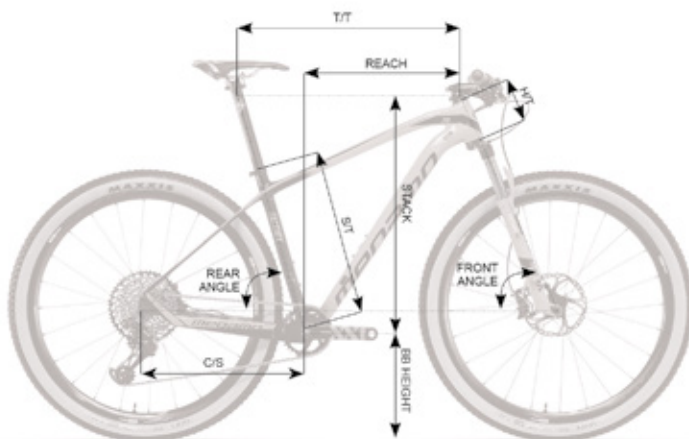







FACTORY 30 EAGLE

	S	M	L	XL
SIZE	16"	17,5"	19"	21"
T/T	575	595	620	645
C/S	445	445	445	445
S/T	409	447	489	530
H/T	102	107	117	132
REACH	384	404	429	454
STACK	624	626	638	652
BB HEIGHT	308	308	308	308
FRONT ANGLE	71	71	71	71
REAR ANGLE	74	74	74	74

FACTORY 40 ORANGE



SPECIFICATIONS / ESPECIFICACIONES

-  FACTORY CARBON ADVANCED FRAME, 12x148 BOOST, INTERNAL CABLE ROUTING, SUITABLE Di2
-  FOX RHYTHM 32, TRAVEL 100mm 15x110 BOOST + REMOTE LOCKOUT
-  FSA 1-1/8 1-1/2 * 1.5 TAPERED
-  MEGAMO FOV COMPACT
-  MEGAMO FOV COMPACT
-  MEGAMO 30,9mm
-  SELLE ITALIA X3

-  SHIMANO SLX 7000 11s
-  FSA COMET BOOST 1x11 (32T)
-  SHIMANO SLX 7000 11s
-  SHIMANO MT500 HYDRAULIC DISC
-  FORMULA ELITE 15x110 BOOST / 12x148 BOOST
-  SUNRINGLE INFERNO 25 15x110 BOOST / 12x148 BOOST
-  MAXXIS IKON 29x2,2 SKINWALL
-  SHIMANO SLX 7000 11s 11-46

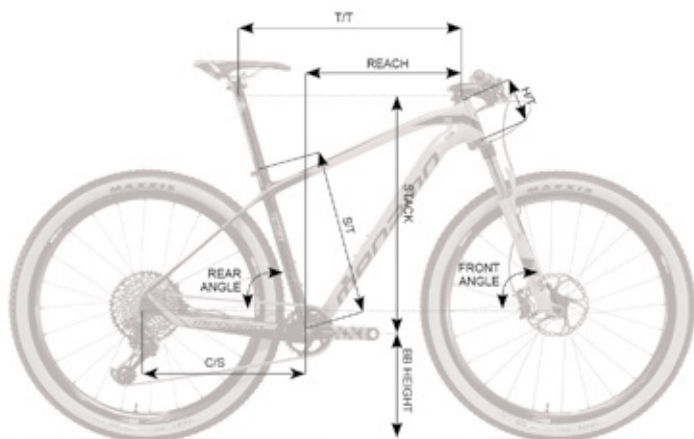

FACTORY 40

	S	M	L	XL
SIZE	16"	17,5"	19"	21"
T/T	575	595	620	645
C/S	445	445	445	445
S/T	409	447	489	530
H/T	102	107	117	132
REACH	384	404	429	454
STACK	624	626	638	652
BB HEIGHT	308	308	308	308
FRONT ANGLE	71	71	71	71
REAR ANGLE	74	74	74	74

FACTORY 40 GREEN

E-BIKES

MTB

ROAD

FAT

TREKKING















CITY

KIDS BMX

WEAR/ROPA



SPECIFICATIONS / ESPECIFICACIONES

-  FACTORY CARBON ADVANCED FRAME, 12x148 BOOST, INTERNAL CABLE ROUTING, SUITABLE Di2
-  FOX RHYTHM 32, TRAVEL 100mm 15x110 BOOST + REMOTE LOCKOUT
-  FSA 1-1/8 1-1/2 * 1.5 TAPERED
-  MEGAMO FOV COMPACT
-  MEGAMO FOV COMPACT
-  MEGAMO 30,9mm
-  SELLE ITALIA X3
-  SHIMANO SLX 7000 11s
-  FSA COMET BOOST 1x11 (32T)
-  SHIMANO SLX 7000 11s
-  SHIMANO MT500 HYDRAULIC DISC
-  FORMULA ELITE 15x110 BOOST / 12x148 BOOST
-  SUNRINGLE INFERNO 25 15x110 BOOST / 12x148 BOOST
-  MAXXIS IKON 29x2,2 SKINWALL
-  SHIMANO SLX 7000 11s 11-46

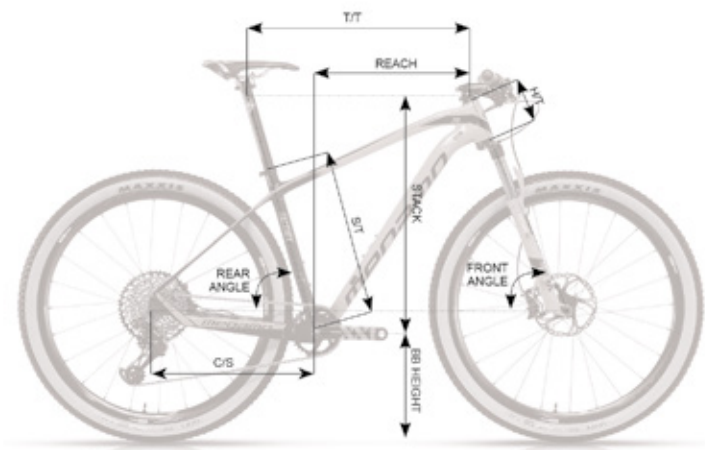















FACTORY 40

	S	M	L	XL
SIZE	16"	17,5"	19"	21"
T/T	575	595	620	645
C/S	445	445	445	445
S/T	409	447	489	530
H/T	102	107	117	132
REACH	384	404	429	454
STACK	624	626	638	652
BB HEIGHT	308	308	308	308
FRONT ANGLE	71	71	71	71
REAR ANGLE	74	74	74	74

FACTORY 40 BLACK



SPECIFICATIONS / ESPECIFICACIONES

 FACTORY CARBON ADVANCED FRAME, 12x148 BOOST, INTERNAL CABLE ROUTING, SUITABLE Di2	 SHIMANO SLX 7000 11s
 FOX RHYTHM 32, TRAVEL 100mm 15x110 BOOST + REMOTE LOCKOUT	 FSA COMET BOOST 1x11 (32T)
 FSA 1-1/8 1-1/2 * 1.5 TAPERED	 SHIMANO SLX 7000 11s
 MEGAMO FOV COMPACT	 SHIMANO MT500 HYDRAULIC DISC
 MEGAMO FOV COMPACT	 FORMULA ELITE 15x110 BOOST / 12x148 BOOST
 MEGAMO 30,9mm	 SUNRINGLE INFERNO 25 15x110 BOOST / 12x148 BOOST
 SELLE ITALIA X3	 MAXXIS IKON 29x2,2 SKINWALL
	 SHIMANO SLX 7000 11s 11-46

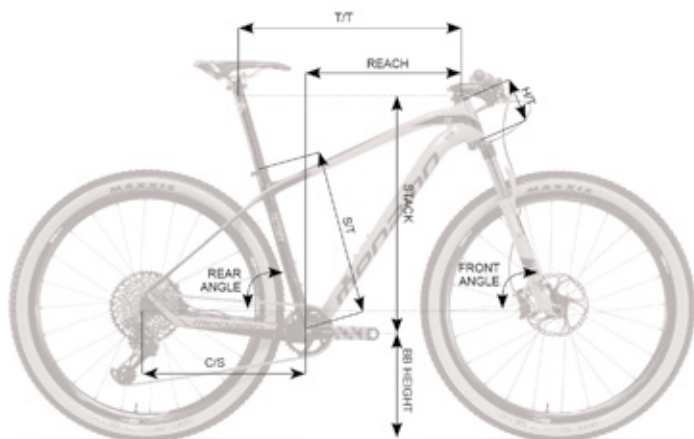

FACTORY 40

	S	M	L	XL
SIZE	16"	17,5"	19"	21"
T/T	575	595	620	645
C/S	445	445	445	445
S/T	409	447	489	530
H/T	102	107	117	132
REACH	384	404	429	454
STACK	624	626	638	652
BB HEIGHT	308	308	308	308
FRONT ANGLE	71	71	71	71
REAR ANGLE	74	74	74	74



WEAR/ROPA

KIDS BMX

CITY

TREKKING

FAT

ROAD

MTB

E-BIKES



Play with the ground of your favourite paths. Descend faster than the last time. Lean into curves. Don't fear braking last minute. Climb to the top. This is Enduro. Enjoy descending but never giving up on hills. After spending time developing, Megamo introduces its new platform called XR. Designed to be strong, comfortable, handy, exciting and confident. The all mountain geometry and the long-travel suspension ensure the perfect traction and grip.

Juega con el terreno de tus senderos favoritos. Baja más rápido que la última vez. Tumbate más al girar. Apura más al frenar. Sube hasta la cima. Esto es enduro. Disfruta cuesta abajo sin temer llegar a la cima. Tras mucho tiempo de desarrollo, Megamo presenta la plataforma XR. Diseñada para ser robusta, comfortable, manejable, divertida y con un buen aplomo. Una geometría all-mountain junto a la suspensión de largo recorrido proporcionan un agarre y tracción nunca antes vistos.



SUSPENSION SYSTEM

A pivot system that optimizes feelings by riding the bike. Designed to go up and down, without pedaling contamination.

SISTEMA SUSPENSIÓN

Un sistema de pivotaje que optimiza sensaciones encima de la bici. Diseñada para subir y bajar, sin contaminación de pedalada existente.

SHORT REAR STAYS

XR is able to trim the length of rear stays and the entire swingarm from the pivot point. Consequently one of the most reactive and agile bikes for the most energetic and sharp turns.

VAINAS TRASERAS CORTAS

XR consigue recortar la longitud de vainas traseras y en conjunto todo el basculante desde el punto de pivotaje. En consecuencia una de las bicicletas más reactivas y ágiles para los giros más energéticos y cortantes.



TAPERED HEAD TUBE

The Zero Stack head tube system, increases the mechanical stiffness on the head set. It contributes on more rigidity and precision on the control of the bike.

TAPERED HEAD TUBE

Este sistema de pipa cónica denominada Zero Stack incrementa la resistencia mecánica al conjunto del juego de dirección aportando mayor rigidez y precisión en el control de la bicicleta.

DIRECT POST MOUNT

The Direct Post Mount standard has so many advantages. For example, the braking action is more efficient, and also the vibes are reduced. In addition, we save a few weight. The situation of the Direct Post Mount into the rear part, reduces the possibility to twist the disc brakes in case of falling.

DIRECT POST MOUNT

















El sistema Post Mount aporta grandes ventajas como una mayor eficacia en la frenada, la reducción de las vibraciones en la pinza así como la disminución del peso. También, al estar ubicada en el interior de las dos vainas, reduce la posibilidad de torsión del disco en caso de caída y le protege de posibles impactos.



XR 05 GREEN



SPECIFICATIONS / ESPECIFICACIONES

-  ALLOY 6061 TRIPLE BUTTED 12x148 BOOST, INTERNAL CABLE ROUTING HORST LINK 4, WHEEL TRAVEL: 140 mm
-  FOX 34 27 '5 RHYTHM Sweep adjust EVOL, 140mm, low/high-speed compression, 15x110mm BOOST
-  FOX FLOAT DPS, P-S, 3 POSITION EVOL LV 190x50
-  FSA ORBIT 1,5 E ZS 1-1/8"-1,5"
-  MEGAMO FOV COMPACT
-  MEGAMO FOV COMPACT
-  TELESCOPIC SEAT POST, REMOTE ADJUSTMENT
-  MEGAMO
-  SHIMANO XT M8000 11s
-  FSA COMET BOOST 1x11 32T
-  SHIMANO SLX 7000 11s
-  SHIMANO MT-500 HYDRAULIC DISC
-  FORMULA ELITE 15x110 BOOST / 12x148 BOOST
-  SUNRINGLE INFERNO 25 15x110 BOOST / 12x148 BOOST
-  MAXXIS ARDENT 27,5x2,4
-  SHIMANO SLX 7000 11s 11-46T

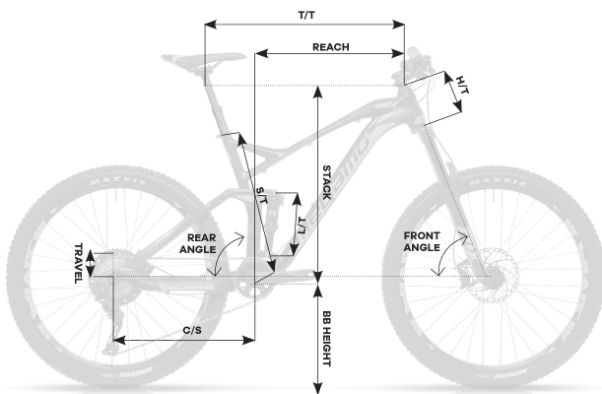











XR 05





27,5"

	S	M	L
SIZE	17"	18,5"	20,5"
T/T	597	620	650
C/S	435	435	435
S/T	432	470	520
H/T	110	115	125
REACH	433	454	482
STACK	591	596	605
FRONT ANGLE	65,7°	65,7°	65,7°
REAR ANGLE	74,5°	74,5°	74,5°
L/T	190x50	190x50	190x50
TRAVEL	140	140	140



SPECIFICATIONS / ESPECIFICACIONES

-  ALLOY 6061 TRIPLE BUTTED 12x148 BOOST, INTERNAL CABLE ROUTING HORST LINK 4, WHEEL TRAVEL: 140 mm
-  FOX 34 27 '5 RHYTHM Sweep adjust EVOL, 140mm, low/high-speed compression, 15x110mm BOOST
-  FOX FLOAT DPS, P-S, 3 POSITION EVOL LV 190x50
-  FSA ORBIT 1,5 E ZS 1-1/8"-1,5"
-  MEGAMO FOV COMPACT
-  MEGAMO FOV COMPACT
-  TELESCOPIC SEAT POST, REMOTE ADJUSTMENT
-  MEGAMO
-  SHIMANO XT M8000 11s
-  FSA COMET BOOST 1x11 32T
-  SHIMANO SLX 7000 11s

-  SHIMANO MT-500 HYDRAULIC DISC
-  FORMULA ELITE 15x110 BOOST / 12x148 BOOST
-  SUNRINGLE INFERNO 25 15x110 BOOST / 12x148 BOOST
-  MAXXIS ARDENT 27,5x2,4
-  SHIMANO SLX 7000 11s 11-46T

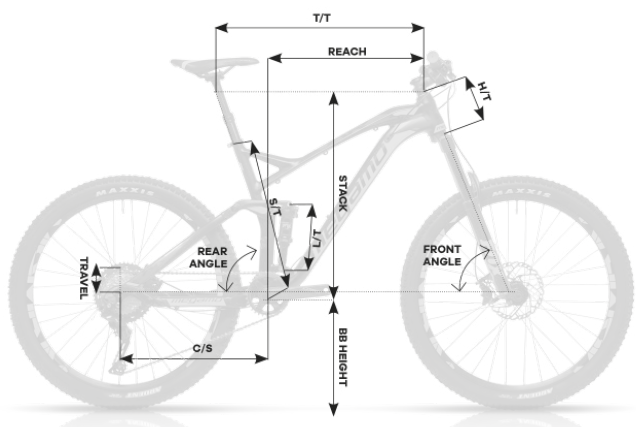

XR 05

















27,5"

	S	M	L
SIZE	17"	18,5"	20,5"
T/T	597	620	650
C/S	435	435	435
S/T	432	470	520
H/T	110	115	125
REACH	433	454	482
STACK	591	596	605
FRONT ANGLE	65,7°	65,7°	65,7°
REAR ANGLE	74,5°	74,5°	74,5°
L/T	190x50	190x50	190x50
TRAVEL	140	140	140

XR 10 GREEN



SPECIFICATIONS / ESPECIFICACIONES

-  ALLOY 6061 TRIPLE BUTTED 12x148 BOOST, INTERNAL CABLE ROUTING HORST LINK 4, WHEEL TRAVEL: 140 mm
-  ROCKSHOX RECON AIR RL 27,5, TRAVEL 140MM, 15x110 BOOST
-  ROCK SHOX MONARCH RL 190x51 Lockout
-  FSA ORBIT 1,5 E ZS 1-1/8"-1,5"
-  MEGAMO FOV COMPACT
-  MEGAMO FOV COMPACT
-  TELESCOPIC SEAT POST, REMOTE ADJUSTMENT
-  MEGAMO
-  SHIMANO DEORE 6000 10s
-  SHIMANO DEORE 6000 10s
-  SHIMANO DEORE 6000 10s
-  SHIMANO DEORE 6000 10s
-  SHIMANO 365 HYDRAULIC DISCS
-  FORMULA ELITE 15x110 BOOST / 12x148 BOOST
-  SUNRINGLE INFERNO 25 15x110 BOOST / 12x148 BOOST
-  MAXXIS ARDENT 27,5x2,4
-  SHIMANO DEORE 6000 10s 11-42T

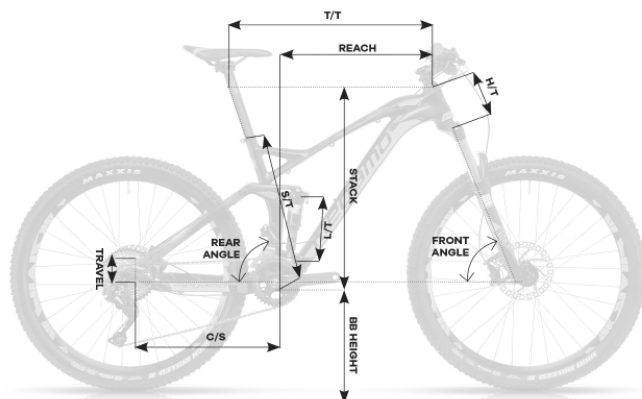













XR 10





27,5"

	S	M	L
SIZE	17"	18,5"	20,5"
T/T	597	620	650
C/S	435	435	435
S/T	432	470	520
H/T	110	115	125
REACH	433	454	482
STACK	591	596	605
FRONT ANGLE	65,7°	65,7°	65,7°
REAR ANGLE	74,5°	74,5°	74,5°
L/T	190x50	190x50	190x50
TRAVEL	140	140	140



SPECIFICATIONS / ESPECIFICACIONES

-  ALLOY 6061 TRIPLE BUTTED 12x148 BOOST, INTERNAL CABLE ROUTING HORST LINK 4, WHEEL TRAVEL: 140 mm
-  ROCKSHOX RECON AIR RL 27,5, TRAVEL 140MM, 15x110 BOOST
-  ROCK SHOX MONARCH RL 190x51 Lockout
-  FSA ORBIT 1,5 E ZS 1-1/8"-1,5"
-  MEGAMO FOV COMPACT
-  MEGAMO FOV COMPACT
-  TELESCOPIC SEAT POST, REMOTE ADJUSTMENT
-  MEGAMO
-  SHIMANO DEORE 6000 10s
-  SHIMANO DEORE 6000 10s
-  SHIMANO DEORE 6000 10s
-  SHIMANO DEORE 6000 10s

-  SHIMANO 365 HYDRAULIC DISCS
-  FORMULA ELITE 15x110 BOOST / 12x148 BOOST
-  SUNRINGLE INFERNO 25 15x110 BOOST / 12x148 BOOST
-  MAXXIS ARDENT 27,5x2,4
-  SHIMANO DEORE 6000 10s 11-42T

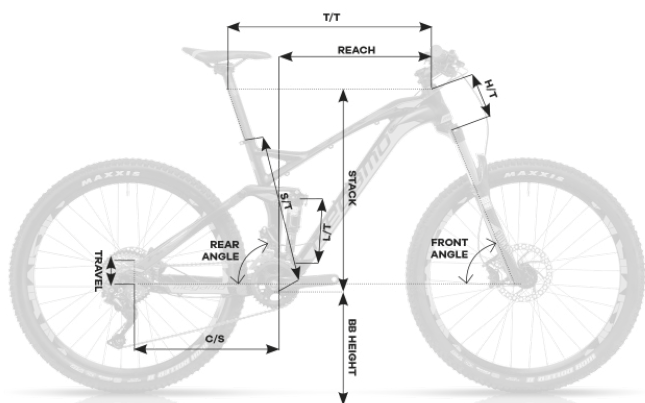

XR 10

27,5"

	S	M	L
SIZE	17"	18,5"	20,5"
T/T	597	620	650
C/S	435	435	435
S/T	432	470	520
H/T	110	115	125
REACH	433	454	482
STACK	591	596	605
FRONT ANGLE	65,7°	65,7°	65,7°
REAR ANGLE	74,5°	74,5°	74,5°
L/T	190x50	190x50	190x50
TRAVEL	140	140	140



Without the rush of races but never giving up in hills, the concept of trail is to ride wherever you want.... even if it's far. These are comfortable and very safe bikes that want high speed. Its comfort helps you during longer routes. There's no ground or trail you won't be able to ride. An all-round bike that allows leaning into curves faster, climbing tops never reached and descending safer thanks to the rear suspension. Pure sensations.

Sin las prisas de las carreras pero sin rendirse en las cuestas, el concepto trail se traduce en pedalear por cualquier terreno. Son bicicletas cómodas con las que se puede llegar a ir muy rápido, siempre de forma segura y sin renunciar a la comodidad que te permitirá realizar rutas de larga duración.

Podrás afrontar cualquier terreno, ningún camino se te resistirá. Una bici versátil y polivalente que te permitirá tomar las curvas más rápido, subir hasta dónde ahora no has llegado y bajar más seguro gracias a la suspensión trasera.

Puras sensaciones.

SINGLE PIVOT

The rear triangle can be directly attached to the rear shock for a fairly linear leverage ratio between wheel travel and shock absorber travel.

The main advantage of the single pivot design is its simplicity. It has few moving parts, few pivot points, has good small bump compliance.

PIVOTE SIMPLE

El triángulo trasero se puede unir directamente al amortiguador trasero para una relación de palanca bastante lineal entre el recorrido de la rueda y el recorrido del amortiguador.

La principal ventaja del diseño de pivote simple es su simplicidad. Tiene pocas partes móviles, pocos puntos de pivote, tiene un buen cumplimiento de baches pequeños.



TAPERED HEAD TUBE

The Zero Stack head tube system, increases the mechanical stiffness on the head set. It contributes on more rigidity and precision on the control of the bike.

TAPERED HEAD TUBE

Este sistema de pipa cónica denominada Zero Stack incrementa la resistencia mecánica al conjunto del juego de dirección aportando mayor rigidez y precisión en el control de la bicicleta.



DIRECT POST MOUNT

The Direct Post Mount standard has so many advantages. For example, the braking action is more efficient, and also the vibes are reduced. In addition, we save a few weight. The situation of the Direct Post Mount into the rear part, reduces the possibility to twist the disc brakes in case of falling.

DIRECT POST MOUNT

















El sistema Post Mount aporta grandes ventajas como una mayor eficacia en la frenada, la reducción de las vibraciones en la pinza así como la disminución del peso. También, al estar ubicada en el interior de las dos vainas, reduce la posibilidad de torsión del disco en caso de caída y le protege de posibles impactos.



XC 03



SPECIFICATIONS / ESPECIFICACIONES

 ALLOY 6061 TRIPLE BUTTED 12x148 BOOST, INTERNAL CABLE ROUTING HORST LINK 4, WHEEL TRAVEL: 110 mm	 SRAM NX EAGLE 12s
 FOX RHYTHM 32 TRAVEL 120mm 15x110 BOOST + REMOTE LOCKOUT	 SRAM NX EAGLE 32T 12s
 FOX FLOAT PERFORMANCE 184x44	 SRAM NX EAGLE 12s
 FSA ORBIT 1,5 E ZS 1-1/8"-1,5"	 SHIMANO MT500 HYDRAULIC DISC
 MEGAMO FOV COMPACT	 FORMULA ELITE 15x110 BOOST / 12x148 BOOST
 MEGAMO FOV COMPACT	 SUNRINGLE INFERNO 25 15x110 BOOST / 12x148 BOOST
 MEGAMO 31,6	 MAXXIS IKON 29x2,2 SKINWALL
 MEGAMO ELITE	 SRAM NX EAGLE 11-50T 12s

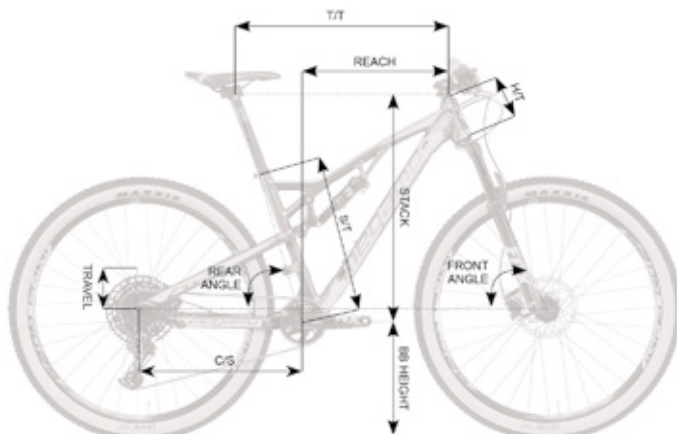

XC 03

	S	M	L
SIZE	15,5"	16,5"	19"
T/T	570	590	605
C/S	450	450	450
S/T	377	420	482
H/T	105	110	120
REACH	398	417	429
STACK	599	604	613
BB HEIGHT	331	331	331
FRONT ANGLE	70	70	70
REAR ANGLE	74	74	74
L/T	184x44	188x44	188x44
TRAVEL	110	110	110



WEAR/ROPA

KIDS BMX

CITY

TREKKING

FAT

ROAD

MTB

E-BIKES

NATURAL



Our aluminium top frame is called Natural Elite. With a modern and racing geometry full of technology: triple butted tube, tapered head tube, rear brake's clamp integrated between tights, internal wiring and adapted for the new Side Swing from Shimano. Nothing is missed in the mounting of this bike. Everything so you can enjoy mountain bike without worrying.

Nuestro cuadro tope de gama en aluminio se llama Natural Elite. Este cuadro de geometría moderna y racing, es pura tecnología: tubería triple butted, pipa de dirección cónica, pinza de disco integrada, cableado interno y anclaje de desviador directo. La bicicleta viene preparado para que no te falte de nada. Todo para disfrutar del ciclismo de montaña sin preocupaciones.



TRIPLE BUTTED

The new anchorage and routing developed by Shimano is a good advantage on technical aspects and esthetic. The gearshift is smoother, and more efficient. The beauty of the frame is increased.

TRIPLE BUTTED

El sistema de desviador desarrollado por SHIMANO nos aporta un gran avance técnico así como estético. Por una parte, nos proporciona una ejecución más suave y eficaz del proceso de cambio y por otro lado el cuadro queda más limpio.

TAPERED HEAD TUBE

The Zero Stack head tube system, increases the mechanical stiffness on the head set. It contributes on more rigidity and precision on the control of the bike.

TAPERED HEAD TUBE

Este sistema de pipa cónica denominada Zero Stack incrementa la resistencia mecánica al conjunto del juego de dirección aportando mayor rigidez y precisión en el control de la bicicleta.



DIRECT POST MOUNT

The Direct Post Mount standard has so many advantages. For example, the braking action is more efficient, and also the vibes are reduced. In addition, we save a few weight. The situation of the Direct Post Mount into the rear part, reduces the possibility to twist the disc brakes in case of falling.







DIRECT POST MOUNT









El sistema Post Mount aporta grandes ventajas como una mayor eficacia en la frenada, la reducción de las vibraciones en la pinza así como la disminución del peso. También, al estar ubicada en el interior de las dos vainas, reduce la posibilidad de torsión del disco en caso de caída y le protege de posibles impactos.

29 NATURAL ELITE 11 EAGLE GREEN



SPECIFICATIONS / ESPECIFICACIONES

-  ALLOY 6061 TRIPLE BUTTED, HYDROFORMED TECHNOLOGY, INTERNAL CABLE ROUTING TAPERED HEAD TUBE
-  FOX RHYTHM 32, TRAVEL 100mm 15x110 BOOST + REMOTE LOCKOUT
-  CH-6502 1-1/8 - 1-1/2" TAPERED
-  MEGAMO FOV COMPACT
-  MEGAMO FOV COMPACT
-  MEGAMO 30,9mm
-  MEGAMO

-  SRAM NX EAGLE 12s
-  SRAM NX EAGLE 32T 12s
-  SRAM NX EAGLE 12s
-  SHIMANO MT500 HYDRAULIC DISC
-  FORMULA
-  SUNRINGLE INFERNO 25
-  MAXXIS IKON 29x2,2 SKINWALL
-  SRAM NX EAGLE 11-50T 12s

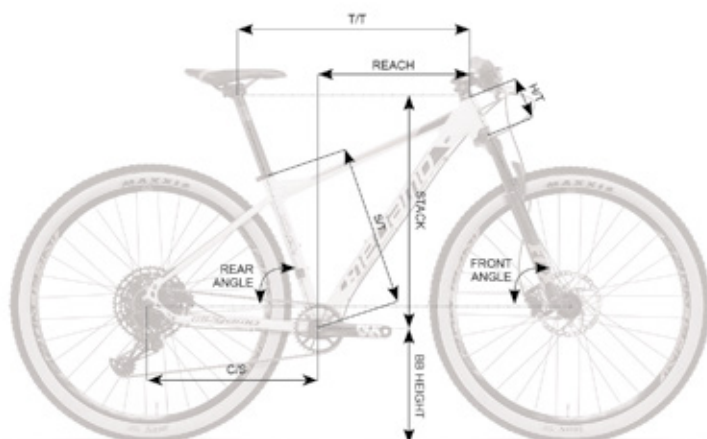

29 NATURAL ELITE 11 EAGLE

	S	M	L	XL
SIZE	15,5"	17"	19"	20,5"
T/T	565	595	620	640
C/S	445	445	445	445
S/T	395	432	470	520
H/T	95	105	110	115
REACH	368	395	419	436
STACK	598	608	612	617
BB HEIGHT	-	-	-	-
FRONT ANGLE	70	70	70	70
REAR ANGLE	72	72	72	72

29 NATURAL ELITE 11 EAGLE GREY

E-BIKES

MTB

ROAD

FAT

TREKKING















CITY

KIDS BMX

WEAR/ROPA



SPECIFICATIONS / ESPECIFICACIONES

-  ALLOY 6061 TRIPLE BUTTED, HYDROFORMED TECHNOLOGY, INTERNAL CABLE ROUTING TAPERED HEAD TUBE
-  FOX RHYTHM 32, TRAVEL 100mm 15x110 BOOST + REMOTE LOCKOUT
-  CH-6502 1-1/8 - 1-1/2" TAPERED
-  MEGAMO FOV COMPACT
-  MEGAMO FOV COMPACT
-  MEGAMO 30,9mm
-  MEGAMO
-  SRAM NX EAGLE 12s
-  SRAM NX EAGLE 32T 12s
-  SRAM NX EAGLE 12s
-  SHIMANO MT500 HYDRAULIC DISC
-  FORMULA
-  SUNRINGLE INFERNO 25
-  MAXXIS IKON 29x2,2 SKINWALL
-  SRAM NX EAGLE 11-50T 12s

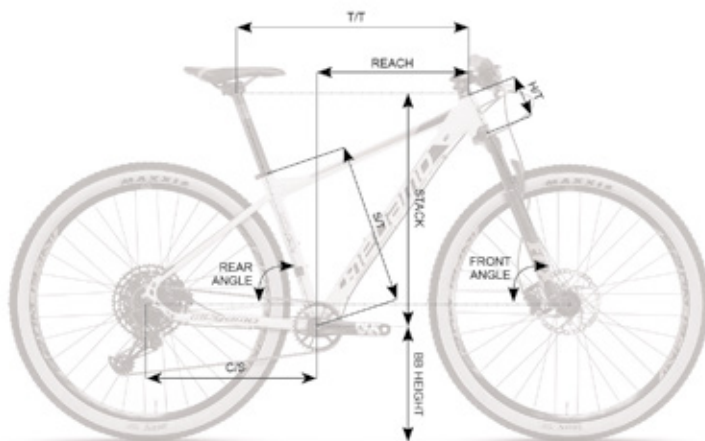















29 NATURAL ELITE 11 EAGLE

	S	M	L	XL
SIZE	15,5"	17"	19"	20,5"
T/T	565	595	620	640
C/S	445	445	445	445
S/T	395	432	470	520
H/T	95	105	110	115
REACH	368	395	419	436
STACK	598	608	612	617
BB HEIGHT	-	-	-	-
FRONT ANGLE	70	70	70	70
REAR ANGLE	72	72	72	72

29 NATURAL ELITE 12 EAGLE GREEN



SPECIFICATIONS / ESPECIFICACIONES

 ALLOY 6061 TRIPLE BUTTED, HYDROFORMED TECHNOLOGY, INTERNAL CABLE ROUTING TAPERED HEAD TUBE	 SRAM NX EAGLE 12s
 ROCK SHOX JUDY SILVER, REMOTE 29" BOOST 15X110MM SOLO AIR 100MM BLACK UPPERS, TAPERED	 SRAM NX EAGLE 32T 12s
 CH-6502 1-1/8 - 1-1/2" TAPERED	 SRAM NX EAGLE 12s
 MEGAMO FOV COMPACT	 SHIMANO MT500 HYDRAULIC DISC
 MEGAMO FOV COMPACT	 FORMULA
 MEGAMO 30,9mm	 SUNRINGLE INFERNO 25
 MEGAMO	 MAXXIS IKON 29x2,2 SKINWALL
	 SRAM NX EAGLE 11-50T 12s

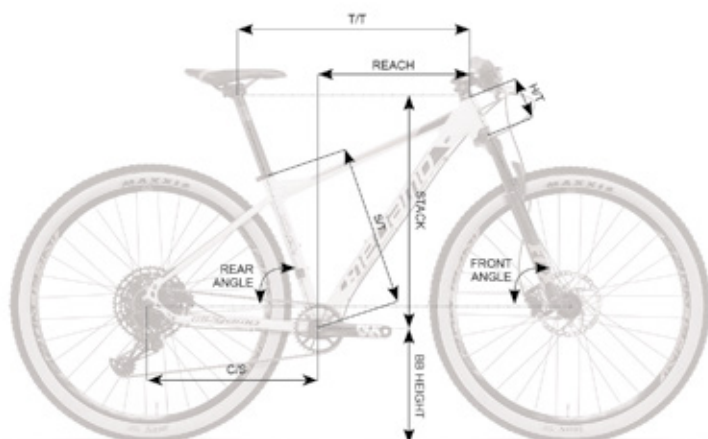

29 NATURAL ELITE 12 EAGLE

	S	M	L	XL
SIZE	15,5"	17"	19"	20,5"
T/T	565	595	620	640
C/S	445	445	445	445
S/T	395	432	470	520
H/T	95	105	110	115
REACH	368	395	419	436
STACK	598	608	612	617
BB HEIGHT	-	-	-	-
FRONT ANGLE	70	70	70	70
REAR ANGLE	72	72	72	72

29 NATURAL ELITE 12 EAGLE GREY

E-BIKES

MTB

ROAD

FAT

TREKKING















CITY

KIDS BMX

WEAR/ROPA



SPECIFICATIONS / ESPECIFICACIONES

 ALLOY 6061 TRIPLE BUTTED, HYDROFORMED TECHNOLOGY, INTERNAL CABLE ROUTING TAPERED HEAD TUBE	 SRAM NX EAGLE 12s
 ROCK SHOX JUDY SILVER, REMOTE 29" BOOST 15X110MM SOLO AIR 100MM BLACK UPPERS, TAPERED	 SRAM NX EAGLE 32T 12s
 CH-6502 1-1/8 - 1-1/2" TAPERED	 SRAM NX EAGLE 12s
 MEGAMO FOV COMPACT	 SHIMANO MT500 HYDRAULIC DISC
 MEGAMO FOV COMPACT	 FORMULA
 MEGAMO 30,9mm	 SUNRINGLE INFERNO 25
 MEGAMO	 MAXXIS IKON 29x2,2 SKINWALL
	 SRAM NX EAGLE 11-50T 12s

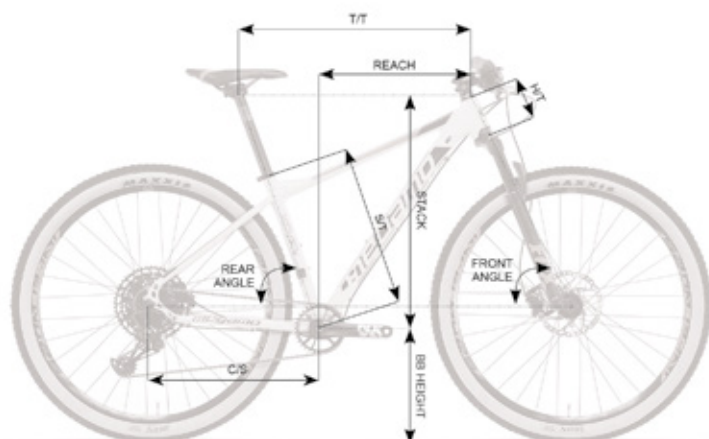















29 NATURAL ELITE 12 EAGLE

	S	M	L	XL
SIZE	15,5"	17"	19"	20,5"
T/T	565	595	620	640
C/S	445	445	445	445
S/T	395	432	470	520
H/T	95	105	110	115
REACH	368	395	419	436
STACK	598	608	612	617
BB HEIGHT	-	-	-	-
FRONT ANGLE	70	70	70	70
REAR ANGLE	72	72	72	72

29 NATURAL ELITE 13 GREEN



SPECIFICATIONS / ESPECIFICACIONES

 ALLOY 6061 TRIPLE BUTTED, HYDROFORMED TECHNOLOGY, INTERNAL CABLE ROUTING TAPERED HEAD TUBE	 SHIMANO SLX 7000 11s
 FOX RHYTHM 32, TRAVEL 100mm 15x110 BOOST + REMOTE LOCKOUT	 FSA COMET 1x11 (32T)
 CH-6502 1-1/8 - 1-1/2" TAPERED	 SHIMANO SLX 7000 11s
 MEGAMO FOV COMPACT	 SHIMANO MT201 HYDRAULIC DISC
 MEGAMO FOV COMPACT	 FORMULA
 MEGAMO 30,9mm	 SUNRINGLE INFERNO 25
 MEGAMO	 MAXXIS IKON 29x2,2
	 SHIMANO SLX 7000 11-46T 11s

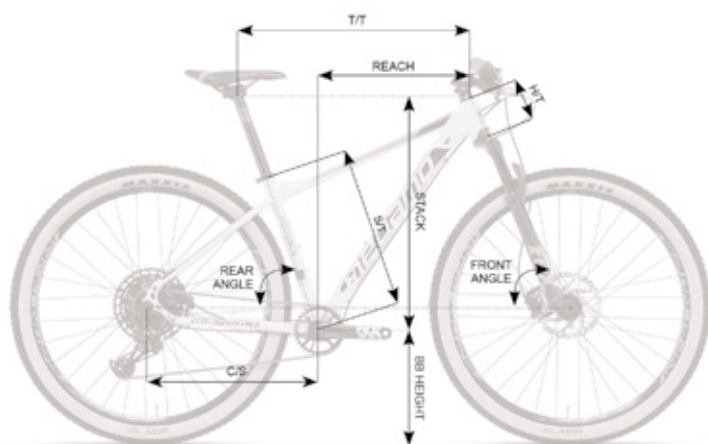

29 NATURAL ELITE 13

	S	M	L	XL
SIZE	15,5"	17"	19"	20,5"
T/T	565	595	620	640
C/S	445	445	445	445
S/T	395	432	470	520
H/T	95	105	110	115
REACH	368	395	419	436
STACK	598	608	612	617
BB HEIGHT	-	-	-	-
FRONT ANGLE	70	70	70	70
REAR ANGLE	72	72	72	72

29 NATURAL ELITE 13 GREY

E-BIKES

MTB

ROAD

FAT

TREKKING







CITY

KIDS BMX

WEAR/ROPA



SPECIFICATIONS / ESPECIFICACIONES

-  ALLOY 6061 TRIPLE BUTTED, HYDROFORMED TECHNOLOGY, INTERNAL CABLE ROUTING TAPERED HEAD TUBE
-  FOX RHYTHM 32, TRAVEL 100mm 15x110 BOOST + REMOTE LOCKOUT
-  CH-6502 1-1/8 - 1-1/2" TAPERED
-  MEGAMO FOV COMPACT
-  MEGAMO FOV COMPACT
-  MEGAMO 30,9mm
-  MEGAMO

-  SHIMANO SLX 7000 11s
-  FSA COMET 1x11 (32T)
-  SHIMANO SLX 7000 11s
-  SHIMANO MT201 HYDRAULIC DISC
-  FORMULA
-  SUNRINGLE INFERNO 25
-  MAXXIS IKON 29x2,2
-  SHIMANO SLX 7000 11-46T 11s

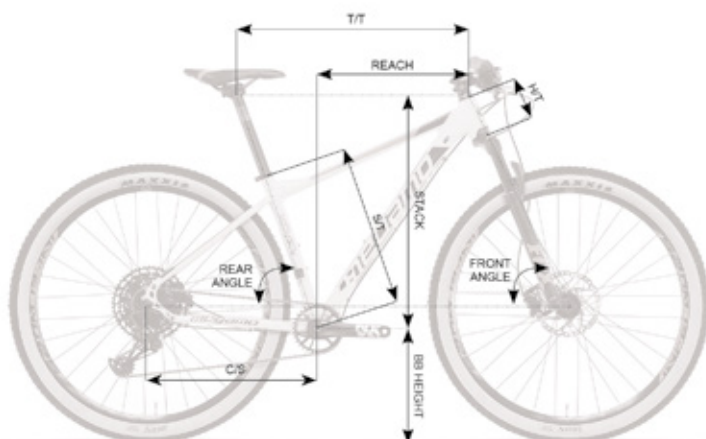

29 NATURAL ELITE 13

	S	M	L	XL
SIZE	15,5"	17"	19"	20,5"
T/T	565	595	620	640
C/S	445	445	445	445
S/T	395	432	470	520
H/T	95	105	110	115
REACH	368	395	419	436
STACK	598	608	612	617
BB HEIGHT	-	-	-	-
FRONT ANGLE	70	70	70	70
REAR ANGLE	72	72	72	72

29 NATURAL ELITE 17 GREEN



SPECIFICATIONS / ESPECIFICACIONES

	ALLOY 6061 TRIPLE BUTTED, HYDROFORMED TECHNOLOGY, INTERNAL CABLE ROUTING TAPERED HEAD TUBE		SHIMANO SLX 7000 11s
	ROCK SHOX JUDY SILVER, REMOTE 29" BOOST 15X110MM SOLO AIR 100MM BLACK UPPERS, TAPERED		FSA COMET 1x11 (32T)
	CH-6502 1-1/8 - 1-1/2" TAPERED		SHIMANO SLX 7000 11s
	MEGAMO FOV COMPACT		SHIMANO MT201 HYDRAULIC DISC
	MEGAMO FOV COMPACT		FORMULA
	MEGAMO 30,9mm		SUNRINGLE INFERNO 25
	MEGAMO		MAXXIS IKON 29x2,2
			SHIMANO SLX 7000 11-46T 11s

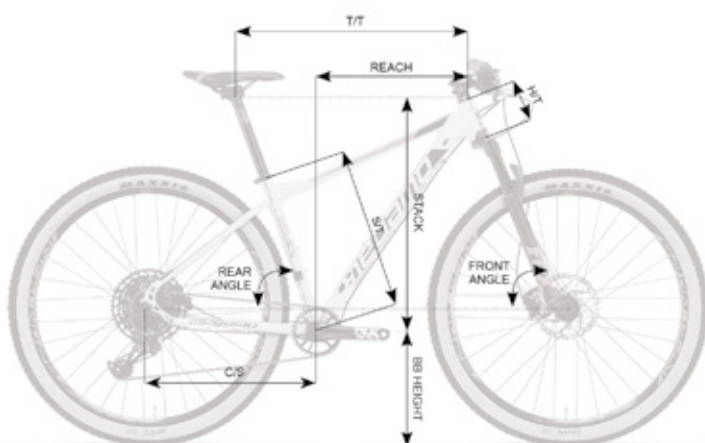







29 NATURAL ELITE 17









	S	M	L	XL
SIZE	15,5"	17"	19"	20,5"
T/T	565	595	620	640
C/S	445	445	445	445
S/T	395	432	470	520
H/T	95	105	110	115
REACH	368	395	419	436
STACK	598	608	612	617
BB HEIGHT	-	-	-	-
FRONT ANGLE	70	70	70	70
REAR ANGLE	72	72	72	72

29 NATURAL ELITE 17 GREY



SPECIFICATIONS / ESPECIFICACIONES

-  ALLOY 6061 TRIPLE BUTTED, HYDROFORMED TECHNOLOGY, INTERNAL CABLE ROUTING TAPERED HEAD TUBE
-  ROCK SHOX JUDY SILVER, REMOTE 29" BOOST 15X110MM SOLO AIR 100MM BLACK UPPERS, TAPERED
-  CH-6502 1-1/8 - 1-1/2" TAPERED
-  MEGAMO FOV COMPACT
-  MEGAMO FOV COMPACT
-  MEGAMO 30,9mm
-  MEGAMO

-  SHIMANO SLX 7000 11s
-  FSA COMET 1x11 (32T)
-  SHIMANO SLX 7000 11s
-  SHIMANO MT201 HYDRAULIC DISC
-  FORMULA
-  SUNRINGLE INFERNO 25
-  MAXXIS IKON 29x2,2
-  SHIMANO SLX 7000 11-46T 11s

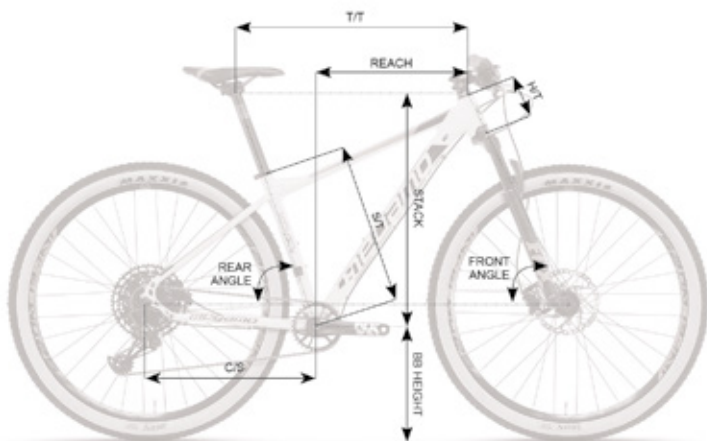









29 NATURAL ELITE 17









	S	M	L	XL
SIZE	15,5"	17"	19"	20,5"
T/T	565	595	620	640
C/S	445	445	445	445
S/T	395	432	470	520
H/T	95	105	110	115
REACH	368	395	419	436
STACK	598	608	612	617
BB HEIGHT	-	-	-	-
FRONT ANGLE	70	70	70	70
REAR ANGLE	72	72	72	72

29 NATURAL RC 35 ORANGE



SPECIFICATIONS / ESPECIFICACIONES

-  ALLOY 6061 TRIPLE BUTTED, HYDROFORMED TECHNOLOGY, INTERNAL CABLE ROUTING TAPERED HEAD TUBE
-  ROCK SHOX JUDY SILVER, REMOTE 29" BOOST 15X110MM SOLO AIR 100MM BLACK UPPERS, TAPERED
-  CH-6502 1-1/8 - 1-1/2" TAPERED
-  MEGAMO FOV COMPACT
-  MEGAMO FOV COMPACT
-  MEGAMO 30,9mm
-  MEGAMO
-  SHIMANO DEORE 6000 10s

-  SHIMANO DEORE 6000 10s
-  SHIMANO DEORE 6000 10s 36-26
-  SHIMANO DEORE 6000 10s
-  SHIMANO MT201 HYDRAULIC DISC
-  FORMULA
-  SUNRINGLE INFERNO 25
-  WTB RANGER 29x2,2
-  SHIMANO DEORE 6000 10s 11-42

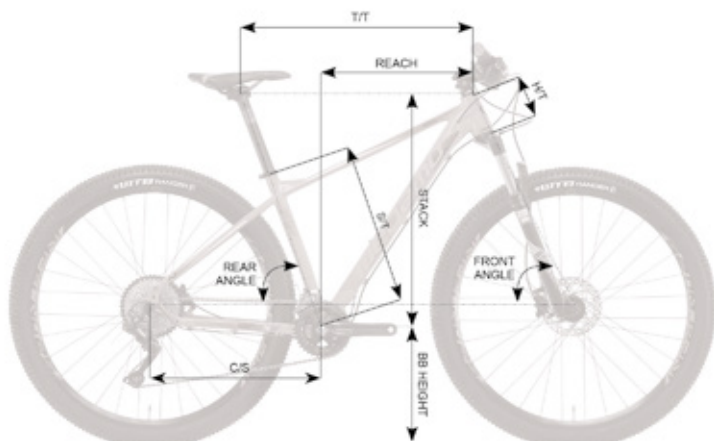

NATURAL RC 35

29"

	S	M	L	XL
SIZE	15,5"	17"	19"	20,5"
T/T	565	595	620	640
C/S	445	445	445	445
S/T	395	432	470	520
H/T	95	105	110	115
REACH	368	395	419	436
STACK	598	608	612	617
BB HEIGHT	-	-	-	-
FRONT ANGLE	70	70	70	70
REAR ANGLE	73	72	72	72

29 NATURAL RC 35 GREY

E-BIKES

MTB

ROAD

FAT

TREKKING















CITY

KIDS BMX

WEAR/ROPA



SPECIFICATIONS / ESPECIFICACIONES

-  ALLOY 6061 TRIPLE BUTTED, HYDROFORMED TECHNOLOGY, INTERNAL CABLE ROUTING TAPERED HEAD TUBE
-  ROCK SHOX JUDY SILVER, REMOTE 29" BOOST 15X110MM SOLO AIR 100MM BLACK UPPERS, TAPERED
-  CH-6502 1-1/8 - 1-1/2" TAPERED
-  MEGAMO FOV COMPACT
-  MEGAMO FOV COMPACT
-  MEGAMO 30,9mm
-  MEGAMO
-  SHIMANO DEORE 6000 10s
-  SHIMANO DEORE 6000 10s 36-26
-  SHIMANO DEORE 6000 10s
-  SHIMANO MT201 HYDRAULIC DISC
-  FORMULA
-  SUNRINGLE INFERNO 25
-  WTB RANGER 29x2,2
-  SHIMANO DEORE 6000 10s 11-42

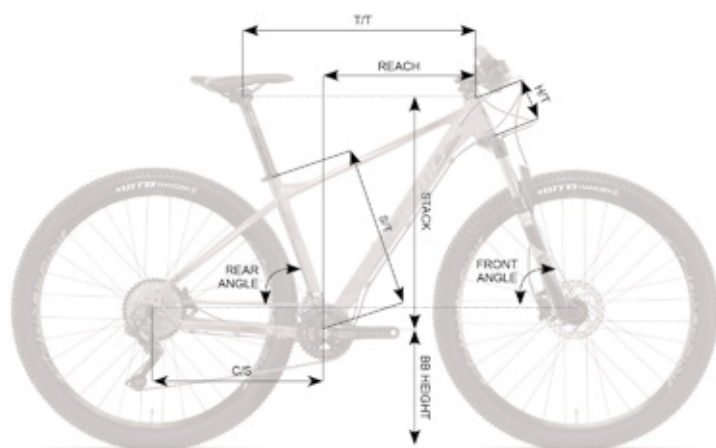

NATURAL RC 35









29"









	S	M	L	XL
SIZE	15,5"	17"	19"	20,5"
T/T	565	595	620	640
C/S	445	445	445	445
S/T	395	432	470	520
H/T	95	105	110	115
REACH	368	395	419	436
STACK	598	608	612	617
BB HEIGHT	-	-	-	-
FRONT ANGLE	70	70	70	70
REAR ANGLE	73	72	72	72

29 NATURAL RC 37 ORANGE



SPECIFICATIONS / ESPECIFICACIONES

-  ALLOY 6061 TRIPLE BUTTED, HYDROFORMED TECHNOLOGY, INTERNAL CABLE ROUTING TAPERED HEAD TUBE
-  SUNTOUR XCR REMOTE LOCKOUT 100mm QR 15mm
-  CH-6502 1-1/8 - 1-1/2" TAPERED
-  MEGAMO FOV COMPACT
-  MEGAMO FOV COMPACT
-  MEGAMO 30,9mm
-  MEGAMO
-  SHIMANO DEORE 6000 10s

-  SHIMANO DEORE 6000 10s
-  SHIMANO DEORE 6000 10s 36-26
-  SHIMANO DEORE 6000 10s
-  SHIMANO MT201 HYDRAULIC DISC
-  FORMULA
-  SUNRINGLE INFERNO 25
-  WTB RANGER 29x2,2
-  SHIMANO DEORE 6000 10s 11-42

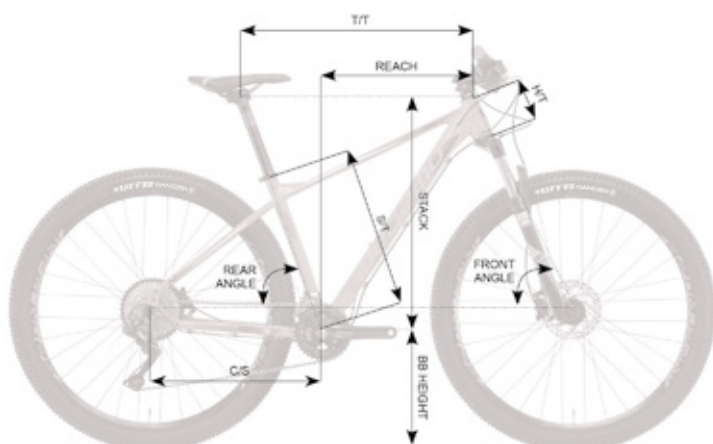

NATURAL RC 37









29"









	S	M	L	XL
SIZE	15,5"	17"	19"	20,5"
T/T	565	595	620	640
C/S	445	445	445	445
S/T	395	432	470	520
H/T	95	105	110	115
REACH	368	395	419	436
STACK	598	608	612	617
BB HEIGHT	-	-	-	-
FRONT ANGLE	70	70	70	70
REAR ANGLE	73	72	72	72

29 NATURAL RC 37 GREY



SPECIFICATIONS / ESPECIFICACIONES

-  ALLOY 6061 TRIPLE BUTTED, HYDROFORMED TECHNOLOGY, INTERNAL CABLE ROUTING TAPERED HEAD TUBE
-  SUNTOUR XCR REMOTE LOCKOUT 100mm QR 15mm
-  CH-6502 1-1/8 - 1-1/2" TAPERED
-  MEGAMO FOV COMPACT
-  MEGAMO FOV COMPACT
-  MEGAMO 30,9mm
-  MEGAMO
-  SHIMANO DEORE 6000 10s

-  SHIMANO DEORE 6000 10s
-  SHIMANO DEORE 6000 10s 36-26
-  SHIMANO DEORE 6000 10s
-  SHIMANO MT201 HYDRAULIC DISC
-  FORMULA
-  SUNRINGLE INFERNO 25
-  WTB RANGER 29x2,2
-  SHIMANO DEORE 6000 10s 11-42

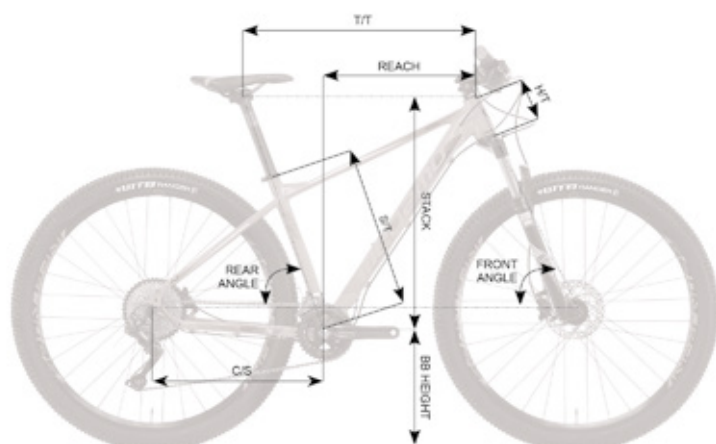

NATURAL RC 37















29"

	S	M	L	XL
SIZE	15,5"	17"	19"	20,5"
T/T	565	595	620	640
C/S	445	445	445	445
S/T	395	432	470	520
H/T	95	105	110	115
REACH	368	395	419	436
STACK	598	608	612	617
BB HEIGHT	-	-	-	-
FRONT ANGLE	70	70	70	70
REAR ANGLE	73	72	72	72

29 NATURAL RC 39 ORANGE



SPECIFICATIONS / ESPECIFICACIONES

 ALLOY 6061 TRIPLE BUTTED, HYDROFORMED TECHNOLOGY, INTERNAL CABLE ROUTING TAPERED HEAD TUBE	 SHIMANO SLX 7000 11s
 SUNTOUR XCR REMOTE LOCKOUT 100mm QR 15mm	 MGM SWHEEL ALUM 32T 1x11s
 CH-6502 1-1/8 - 1-1/2" TAPERED	 SHIMANO SLX 7000 11s
 MEGAMO FOV COMPACT	 SHIMANO MT200 HYDRAULIC DISC
 MEGAMO FOV COMPACT	 FORMULA
 MEGAMO 30,9mm	 SUNRINGLE INFERNO 25
 MEGAMO	 WTB RANGER 29x2,2
	 SHIMANO SLX 7000 11-46T 11s

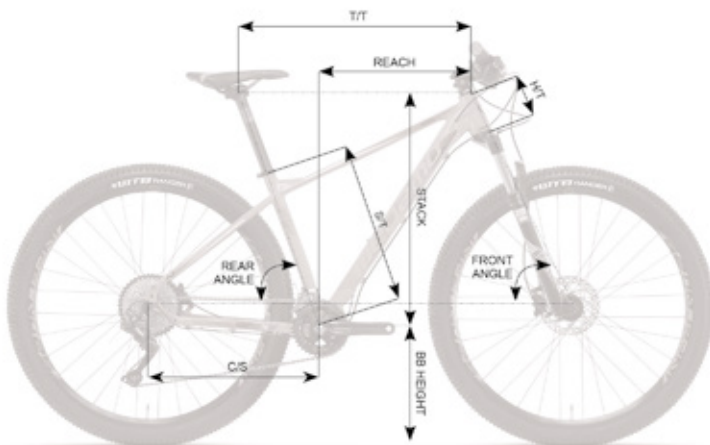

NATURAL RC 39

29"

	S	M	L	XL
SIZE	15,5"	17"	19"	20,5"
T/T	565	595	620	640
C/S	445	445	445	445
S/T	395	432	470	520
H/T	95	105	110	115
REACH	368	395	419	436
STACK	598	608	612	617
BB HEIGHT	-	-	-	-
FRONT ANGLE	70	70	70	70
REAR ANGLE	73	72	72	72

29 NATURAL RC 39 GREY

E-BIKES

MTB

ROAD

FAT

TREKKING







CITY

KIDS BMX

WEAR/ROPA



SPECIFICATIONS / ESPECIFICACIONES

-  ALLOY 6061 TRIPLE BUTTED, HYDROFORMED TECHNOLOGY, INTERNAL CABLE ROUTING TAPERED HEAD TUBE
-  SUNTOUR XCR REMOTE LOCKOUT 100mm QR 15mm
-  CH-6502 1-1/8 - 1-1/2" TAPERED
-  MEGAMO FOV COMPACT
-  MEGAMO FOV COMPACT
-  MEGAMO 30,9mm
-  MEGAMO

-  SHIMANO SLX 7000 11s
-  MGM SWHEEL ALUM 32T 1x11s
-  SHIMANO SLX 7000 11s
-  SHIMANO MT200 HYDRAULIC DISC
-  FORMULA
-  SUNRINGLE INFERNO 25
-  WTB RANGER 29x2,2
-  SHIMANO SLX 7000 11-46T 11s

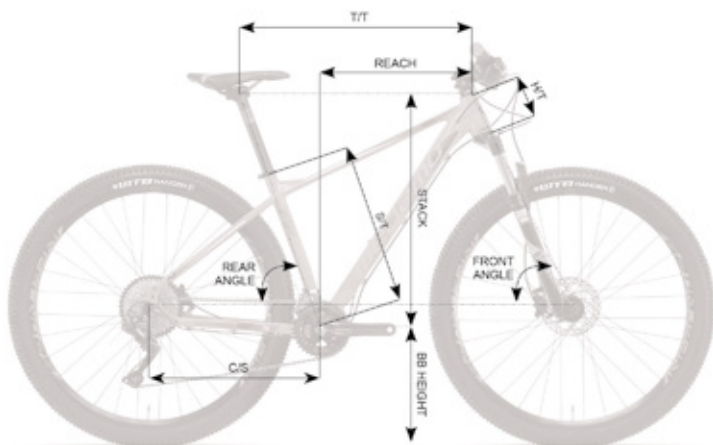

NATURAL RC 39









29"









	S	M	L	XL
SIZE	15,5"	17"	19"	20,5"
T/T	565	595	620	640
C/S	445	445	445	445
S/T	395	432	470	520
H/T	95	105	110	115
REACH	368	395	419	436
STACK	598	608	612	617
BB HEIGHT	-	-	-	-
FRONT ANGLE	70	70	70	70
REAR ANGLE	73	72	72	72

29/27,5 NATURAL 40 ORANGE



SPECIFICATIONS / ESPECIFICACIONES

-  ALLOY 6061 DOUBLE BUTTED, HYDROFORMED TECHNOLOGY, INTERNAL CABLE ROUTING
-  SUNTOUR XCM RLO REMOTE LOCKOUT
-  CH-9190 1-1/8" SEMI INTEGRATED
-  MEGAMO FOV COMPACT
-  MEGAMO FOV COMPACT
-  MEGAMO 27,2mm
-  MEGAMO
-  SHIMANO ACERA 3000 9s

-  SHIMANO ACERA 3x9s
-  SHIMANO TX 701
-  SHIMANO 391 OCTALINK 44-32-22 T
-  SHIMANO MT200 HYDRAULIC DISC
-  FORMULA
-  MEGAMO DOBLE WALL ALLOY DISC
-  WTB RANGER 29x2,2
-  SHIMANO HG-20 9s 11/34T

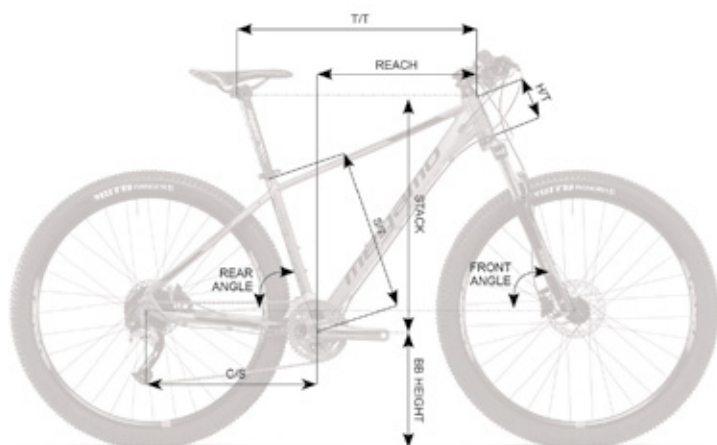

NATURAL 40

29"









27,5"









	29"				27,5"	
	S	M	L	XL	S	M
SIZE	15,5"	17,5"	19"	21"	15"	17,5"
T/T	575	600	625	650	555	600
C/S	450	450	450	450	435	435
S/T	395	440	480	530	385	440
H/T	105	115	125	135	95	115
REACH	394	416	439	461	385	425
STACK	610	620	630	640	573	592
BB HEIGHT	-	-	-	-	-	-
FRONT ANGLE	69	69	69	69	69	69
REAR ANGLE	73,5	73,5	73,5	73,5	73,5	73,5

29/27,5 NATURAL 40 GREY



SPECIFICATIONS / ESPECIFICACIONES

-  ALLOY 6061 DOUBLE BUTTED, HYDROFORMED TECHNOLOGY, INTERNAL CABLE ROUTING
-  SUNTOUR XCM RLO REMOTE LOCKOUT
-  CH-9190 1-1/8" SEMI INTEGRATED
-  MEGAMO FOV COMPACT
-  MEGAMO FOV COMPACT
-  MEGAMO 27,2mm
-  MEGAMO
-  SHIMANO ACERA 3000 9s

-  SHIMANO ACERA 3x9s
-  SHIMANO TX 701
-  SHIMANO 391 OCTALINK 44-32-22 T
-  SHIMANO MT200 HYDRAULIC DISC
-  FORMULA
-  MEGAMO DOBLE WALL ALLOY DISC
-  WTB RANGER 29x2,2
-  SHIMANO HG-20 9s 11/34T

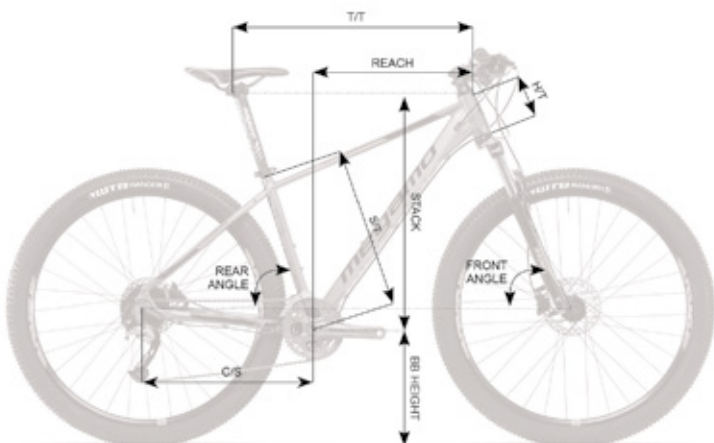

NATURAL 40

29"









27,5"









	29"				27,5"	
	S	M	L	XL	S	M
SIZE	15,5"	17,5"	19"	21"	15"	17,5"
T/T	575	600	625	650	555	600
C/S	450	450	450	450	435	435
S/T	395	440	480	530	385	440
H/T	105	115	125	135	95	115
REACH	394	416	439	461	385	425
STACK	610	620	630	640	573	592
BB HEIGHT	-	-	-	-	-	-
FRONT ANGLE	69	69	69	69	69	69
REAR ANGLE	73,5	73,5	73,5	73,5	73,5	73,5

29/27,5 NATURAL 50 GREEN



SPECIFICATIONS / ESPECIFICACIONES

-  ALLOY 6061, HYDROFORMED TECHNOLOGY, INTERNAL CABLE ROUTING
-  SUNTOUR XCT HLO LOCKOUT 100mm
-  CH-9190 1-1/8" SEMI INTEGRATED
-  MEGAMO FOV COMPACT
-  MEGAMO FOV COMPACT
-  MEGAMO 27,2mm
-  MEGAMO
-  SHIMANO ALTUS 310

-  SHIMANO TX800
-  SHIMANO TX 701
-  SHIMANO ALTUS 310
-  SHIMANO MT200 HYDRAULIC DISC
-  FORMULA
-  MEGAMO DOBLE WALL ALLOY DISC
-  29" x 2,1 MTB / 27,5" x 2,1 MTB
-  SHIMANO HG-20 8s 12/32T

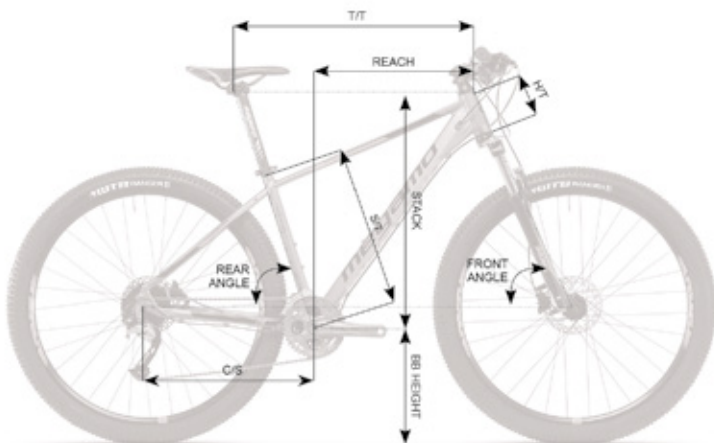

NATURAL 50

29"







27,5"









	29"				27,5"	
	S	M	L	XL	S	M
SIZE	15,5"	17,5"	19"	21"	15"	17,5"
T/T	575	600	625	650	555	600
C/S	450	450	450	450	435	435
S/T	395	440	480	530	385	440
H/T	105	115	125	135	95	115
REACH	394	416	439	461	385	425
STACK	610	620	630	640	573	592
BB HEIGHT	-	-	-	-	-	-
FRONT ANGLE	69	69	69	69	69	69
REAR ANGLE	73,5	73,5	73,5	73,5	73,5	73,5

29/27,5 NATURAL 50 YELLOW



SPECIFICATIONS / ESPECIFICACIONES

-  ALLOY 6061, HYDROFORMED TECHNOLOGY, INTERNAL CABLE ROUTING
-  SUNTOUR XCT HLO LOCKOUT 100mm
-  CH-9190 1-1/8" SEMI INTEGRATED
-  MEGAMO FOV COMPACT
-  MEGAMO FOV COMPACT
-  MEGAMO 27,2mm
-  MEGAMO
- SHIMANO ALTUS 310

-  SHIMANO TX800
-  SHIMANO TX 701
-  SHIMANO ALTUS 310
-  SHIMANO MT200 HYDRAULIC DISC
-  FORMULA
-  MEGAMO DOBLE WALL ALLOY DISC
-  29" x 2,1 MTB / 27,5" x 2,1 MTB
-  SHIMANO HG-20 8s 12/32T

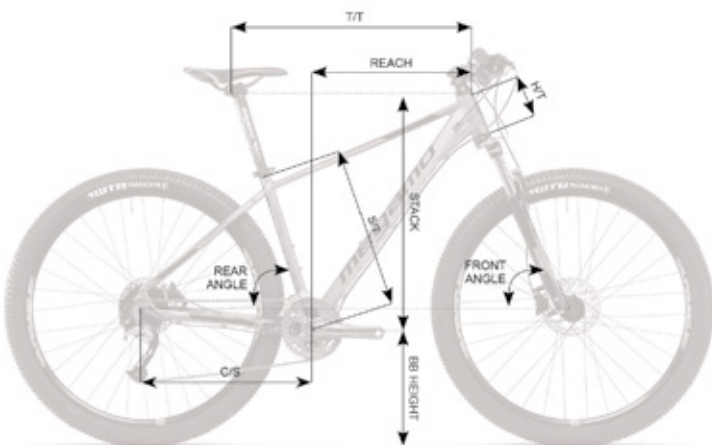

NATURAL 50

29"









27,5"









	29"				27,5"	
	S	M	L	XL	S	M
SIZE	15,5"	17,5"	19"	21"	15"	17,5"
T/T	575	600	625	650	555	600
C/S	450	450	450	450	435	435
S/T	395	440	480	530	385	440
H/T	105	115	125	135	95	115
REACH	394	416	439	461	385	425
STACK	610	620	630	640	573	592
BB HEIGHT	-	-	-	-	-	-
FRONT ANGLE	69	69	69	69	69	69
REAR ANGLE	73,5	73,5	73,5	73,5	73,5	73,5

29/27,5 NATURAL 60 YELLOW



SPECIFICATIONS / ESPECIFICACIONES

-  ALLOY 6061, HYDROFORMED TECHNOLOGY, INTERNAL CABLE ROUTING
-  SUNTOUR XCE
-  CH-9190 1-1/8" SEMI INTEGRATED
-  MEGAMO FOV COMPACT
-  MEGAMO FOV COMPACT
-  MEGAMO 27,2mm
-  MEGAMO
-  SHIMANO TY300

-  SHIMANO TY300
-  SHIMANO TY301 42/34/24
-  SHIMANO ASLM 310 3x7
-  SHIMANO MT200 HYDRAULIC DISC
-  FORMULA
-  MEGAMO DOBLE WALL ALLOY DISC
-  29" x 2,1 MTB / 27,5" x 2,1 MTB
-  SHIMANO AMF TZ-21 7s

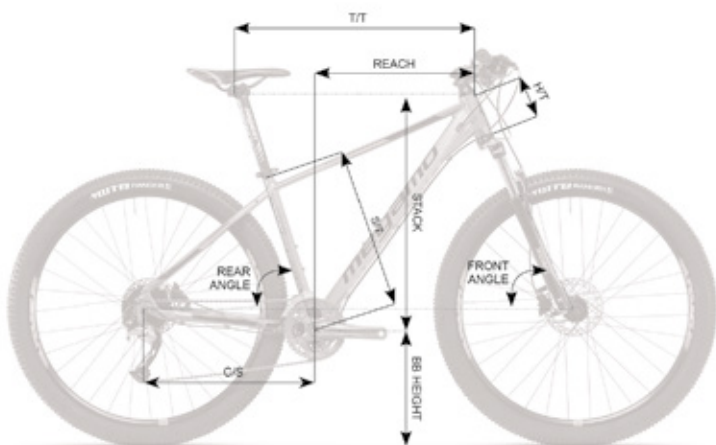

NATURAL 60

29"

27,5"

	29"				27,5"	
	S	M	L	XL	S	M
SIZE	15,5"	17,5"	19"	21"	15"	17,5"
T/T	575	600	625	650	555	600
C/S	450	450	450	450	435	435
S/T	395	440	480	530	385	440
H/T	105	115	125	135	95	115
REACH	394	416	439	461	385	425
STACK	610	620	630	640	573	592
BB HEIGHT	-	-	-	-	-	-
FRONT ANGLE	69	69	69	69	69	69
REAR ANGLE	73,5	73,5	73,5	73,5	73,5	73,5

29/27,5 NATURAL 60 GREEN

E-BIKES

MTB

ROAD

FAT

TREKKING









CITY









KIDS BMX

WEAR/ROPA



SPECIFICATIONS / ESPECIFICACIONES

-  ALLOY 6061, HYDROFORMED TECHNOLOGY, INTERNAL CABLE ROUTING
-  SUNTOUR XCE
-  CH-9190 1-1/8" SEMI INTEGRATED
-  MEGAMO FOV COMPACT
-  MEGAMO FOV COMPACT
-  MEGAMO 27,2mm
-  MEGAMO
-  SHIMANO TY300

-  SHIMANO TY300
-  SHIMANO TY301 42/34/24
-  SHIMANO ASLM 310 3x7
-  SHIMANO MT200 HYDRAULIC DISC
-  FORMULA
-  MEGAMO DOBLE WALL ALLOY DISC
-  29" x 2,1 MTB / 27,5" x 2,1 MTB
-  SHIMANO AMF TZ-21 7s

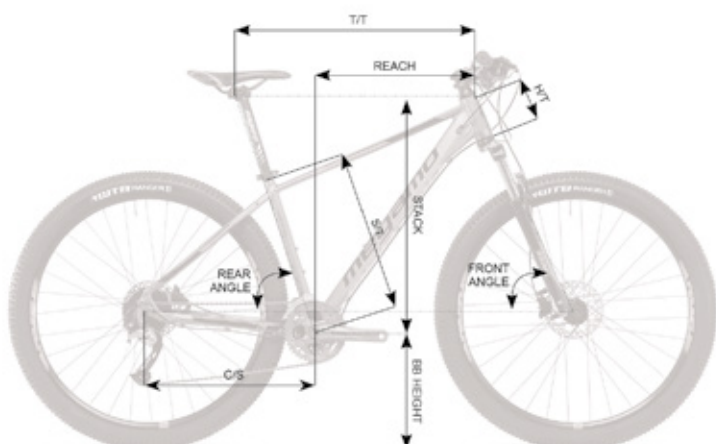

NATURAL 60

29"

















27,5"

	29"				27,5"	
	S	M	L	XL	S	M
SIZE	15,5"	17,5"	19"	21"	15"	17,5"
T/T	575	600	625	650	555	600
C/S	450	450	450	450	435	435
S/T	395	440	480	530	385	440
H/T	105	115	125	135	95	115
REACH	394	416	439	461	385	425
STACK	610	620	630	640	573	592
BB HEIGHT	-	-	-	-	-	-
FRONT ANGLE	69	69	69	69	69	69
REAR ANGLE	73,5	73,5	73,5	73,5	73,5	73,5

29/27,5 NATURAL 60 ORANGE



SPECIFICATIONS / ESPECIFICACIONES

 ALLOY 6061, HYDROFORMED TECHNOLOGY, INTERNAL CABLE ROUTING	 SHIMANO TY300
 SUNTOUR XCE	 SHIMANO TY301 42/34/24
 CH-9190 1-1/8" SEMI INTEGRATED	 SHIMANO ASLM 310 3x7
 MEGAMO FOV COMPACT	 SHIMANO MT200 HYDRAULIC DISC
 MEGAMO FOV COMPACT	 FORMULA
 MEGAMO 27,2mm	 MEGAMO DOBLE WALL ALLOY DISC
 MEGAMO	 29" x 2,1 MTB / 27,5" x 2,1 MTB
 SHIMANO TY300	 SHIMANO AMF TZ-21 7s

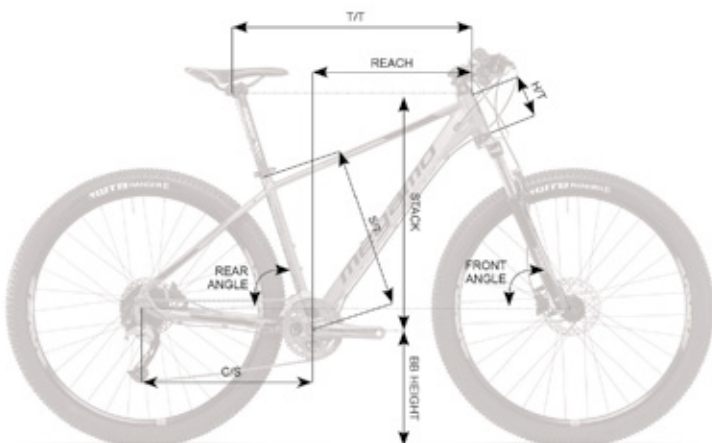

NATURAL 60

29"

27,5"

	29"				27,5"	
	S	M	L	XL	S	M
SIZE	15,5"	17,5"	19"	21"	15"	17,5"
T/T	575	600	625	650	555	600
C/S	450	450	450	450	435	435
S/T	395	440	480	530	385	440
H/T	105	115	125	135	95	115
REACH	394	416	439	461	385	425
STACK	610	620	630	640	573	592
BB HEIGHT	-	-	-	-	-	-
FRONT ANGLE	69	69	69	69	69	69
REAR ANGLE	73,5	73,5	73,5	73,5	73,5	73,5



WEAR/ROPA

KIDS BMX

CITY

TREKKING

FAT

ROAD

MTB

E-BIKES

29/27,5 DX3 BLACK / GREEN

**29/27,5 DX3
BLACK**



**29/27,5 DX3
GREEN**



SPECIFICATIONS / ESPECIFICACIONES

 ALLOY 6061 HYDROFORMED

 ALLOY DISC 386

 SHIMANO TX800

 SHIMANO TZ30

 MEGAMO 920 ALLOY 42-32-22 T

 SHIMANO EF41

 SHIMANO EF41

 MEGAMO DOBLE WALL ALLOY DISC

 29" x 2,1 MTB / 27,5" x 2,1 MTB

 SHIMANO TZ21 7s 14-28 T

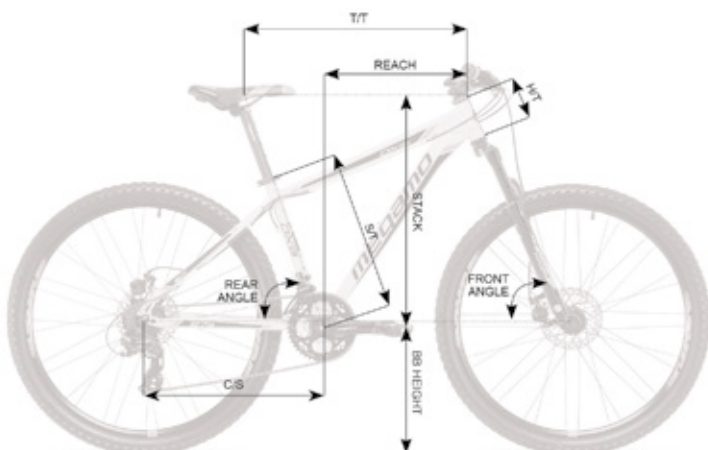

DX3

29"

27,5"

	S	M	L	XL	XS	S	M
SIZE	15"	17"	19"	21"	13	15,5"	18"
T/T	545	573	590	615	530	545	605
C/S	450	450	450	450	440	440	440
S/T	381	432	483	533	330	395	460
H/T	110	120	130	140	80	100	130
FRONT ANGLE	70°	70°	70°	70°	70	70	70
REAR ANGLE	73°	73°	73°	73°	73	73	73

27,5 FUN BLUE / GREEN

**27,5 FUN
BLUE**



**27,5 FUN
GREEN**



SPECIFICATIONS / ESPECIFICACIONES

 ALLOY 6061 HYDROFORMED

 ALLOY 386 80mm

 SHIMANO TX800

 SHIMANO TZ30

 MEGAMO 920 ALLOY 42-32-22 T

 SHIMANO EF41

 SHIMANO EF41

 DOUBLE WALL ALLOY V-BRAKE

 27,5 x 210

 SHIMANO TZ21 7s 14-28 T

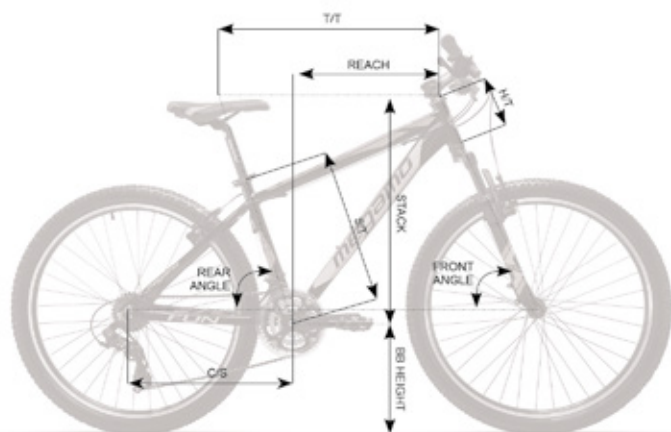

FUN

27,5"

	XS	S	M	L
SIZE	13,5"	16"	18"	21"
T/T	550	560	580	594
C/S	440	440	440	440
S/T	343	406	460	533
H/T	120	120	130	140
FRONT ANGLE	70°	70°	70°	70°
REAR ANGLE	73°	73°	73°	73°

27,5 FUN LADY GREY / WHITE





**27,5 FUN LADY
GREY**







**27,5 FUN LADY
WHITE**



SPECIFICATIONS / ESPECIFICACIONES

-  ALLOY 6061 HYDROFORMED
-  ALLOY 386 80mm
-  SHIMANO TX800
-  SHIMANO TZ30
-  MEGAMO 920 ALLOY 42-32-22 T

-  SHIMANO EF41
-  SHIMANO EF41
-  DOUBLE WALL ALLOY V-BRAKE
-  27,5" x 2,1"
-  SHIMANO TZ21 7s 14-28 T

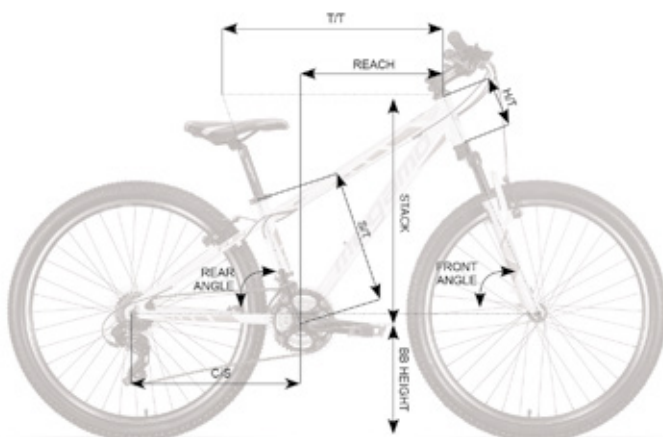

FUN LADY

27,5"

	XS	XM
SIZE	13,5"	16"
T/T	550	560
C/S	440	440
S/T	343	400
H/T	130	140
FRONT ANGLE	70°	70°
REAR ANGLE	73°	73°

26 KU2 DISC YELLOW / BLACK





26 KU2 DISC YELLOW







26 KU2 DISC BLACK



SPECIFICATIONS / ESPECIFICACIONES

-  ALLOY 6061 HYDROFORMED
-  ALLOY DISC 381
-  SHIMANO TX35 21s
-  SHIMANO TZ30
-  MEGAMO 920 42-32-22 T

-  SHIMANO EF41
-  SHIMANO EF41
-  MEGAMO DOBLE WALL ALLOY DISC
-  26" x 1,95"
-  SHIMANO TZ21 7s 14-28 T

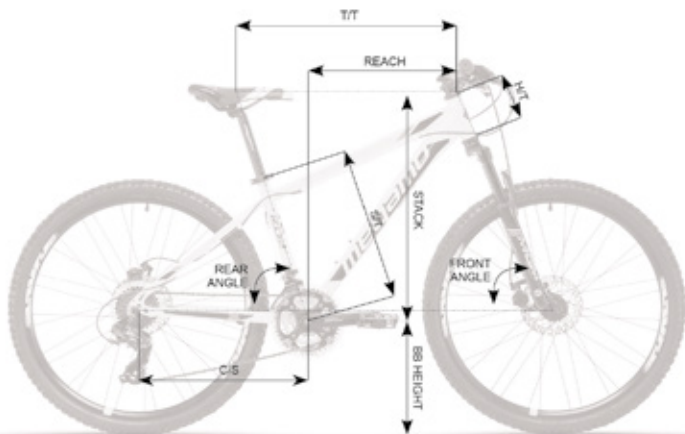

KU2









26"









	XS	S	M
SIZE	13"	15"	17"
T/T	530	550	575
C/S	425	425	425
S/T	330	381	431
H/T	100	110	120
FRONT ANGLE	70°	70°	70°
REAR ANGLE	73°	73°	73°

24 KU4



SPECIFICATIONS / ESPECIFICACIONES

	ALLOY 6061 HYDROFORMED
	ALLOY DISC 381
	AHEAD CH-281
	MEGAMO FOV
	MEGAMO FOV
	MEGAMO 27,2mm
	MEGAMO
	SHIMANO TX35 21s

	SHIMANO TZ30
	MEGAMO 920 42-32-22 T
	SHIMANO EF41
	SHIMANO EF41
	FORMULA ALLOY
	MEGAMO DOBLE WALL ALLOY DISC
	24 x 1,95 MTB
	SHIMANO TZ21 7s 14-28 T

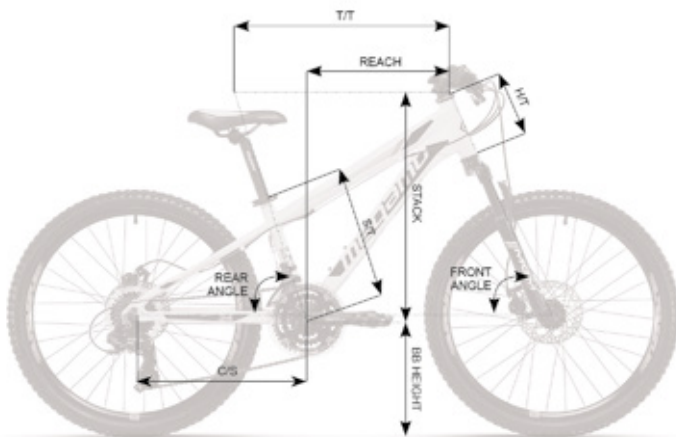

KU4

24"

one size

SIZE	12"
T/T	518
C/S	410
S/T	310
H/T	145
FRONT ANGLE	71°
REAR ANGLE	73°

26 OPEN REPLICA ORANGE / GREY





26 OPEN REPLICA
ORANGE







26 OPEN REPLICA
GREY



SPECIFICATIONS / ESPECIFICACIONES

-  ALLOY 6061 HYDROFORMED
-  ALLOY 386 80mm
-  SHIMANO TX35 21s
-  SHIMANO TZ30
-  MEGAMO 920 42-32-22 T

-  SHIMANO EF41
-  SHIMANO EF41
-  ALLOY SCOUT BLACK
-  26" x 1.95"
-  SHIMANO TZ21 7s 14-28 T

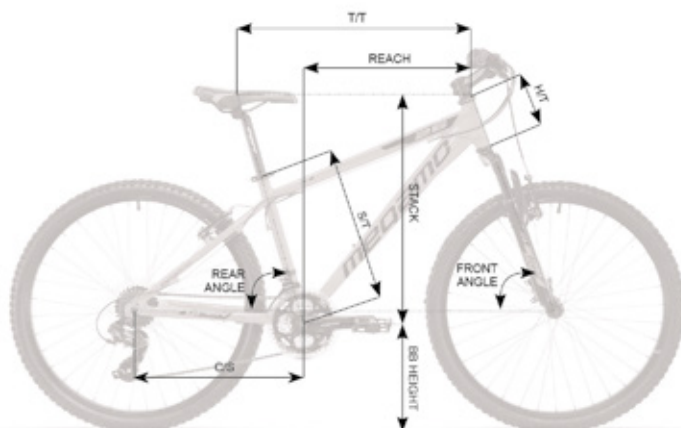

OPEN REPLICA

26"

	XS	S	M	L
SIZE	13"	15,5"	18"	20"
T/T	516	560	575	589
C/S	425	425	425	425
S/T	330	395	460	508
H/T	110	120	130	140
FRONT ANGLE	70°	70°	70°	70°
REAR ANGLE	73°	73°	73°	73°

26 OPEN REPLICA BLUE / YELLOW

26 OPEN REPLICA BLUE



26 OPEN REPLICA YELLOW



SPECIFICATIONS / ESPECIFICACIONES

 ALLOY 6061 HYDROFORMED

 ALLOY 386 80mm

 SHIMANO TX35 21s

 SHIMANO TZ30

 MEGAMO 920 42-32-22 T

 SHIMANO EF41

 SHIMANO EF41

 ALLOY SCOUT BLACK

 26" x 1.95"

 SHIMANO TZ21 7s 14-28 T

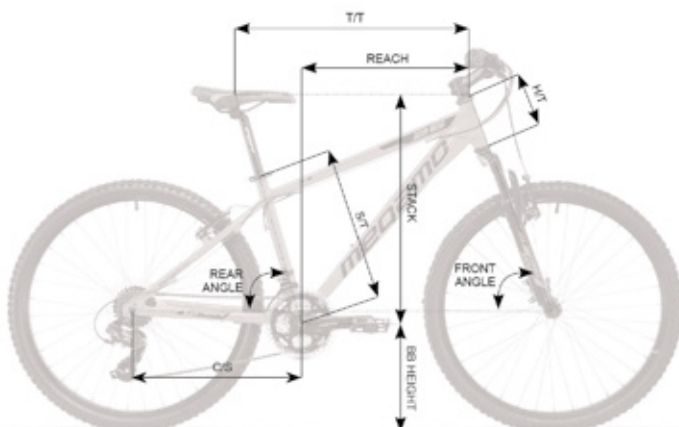

OPEN REPLICA

26"

	XS	S	M	L
SIZE	13"	15,5"	18"	20"
T/T	516	560	575	589
C/S	425	425	425	425
S/T	330	395	460	508
H/T	110	120	130	140
FRONT ANGLE	70°	70°	70°	70°
REAR ANGLE	73°	73°	73°	73°

26 OPEN REPLICA LADY GREEN / BLUE





26 OPEN REPLICA LADY GREEN







26 OPEN REPLICA LADY BLUE



SPECIFICATIONS / ESPECIFICACIONES

-  ALLOY 6061 HYDROFORMED
-  ALLOY 386 80mm
-  SHIMANO TX35 21s
-  SHIMANO TZ30
-  MEGAMO 920 42-32-22 T

-  SHIMANO EF41
-  SHIMANO EF41
-  ALLOY SCOUT BLACK
-  26" x 1.95"
-  SHIMANO TZ21 7s 14-28 T

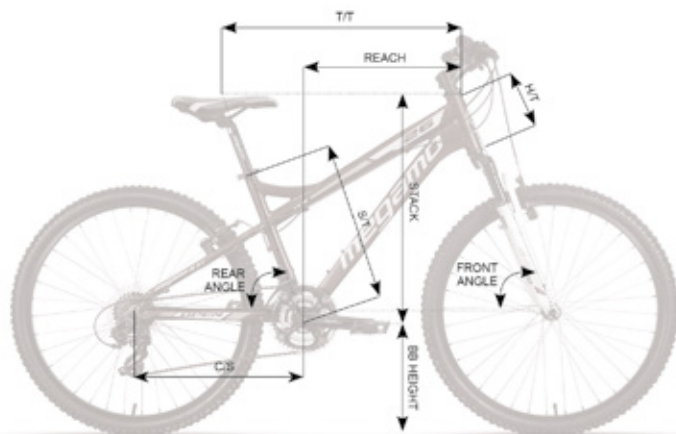

OPEN REPLICA LADY 26"

	XS	XM
SIZE	14"	16"
T/T	537	553
C/S	435	435
S/T	360	400
H/T	150	150
FRONT ANGLE	71°	72°
REAR ANGLE	71°	72°

26 OPEN REPLICA LADY GREY / PINK

26 OPEN REPLICA LADY
GREY



26 OPEN REPLICA LADY
PINK



SPECIFICATIONS / ESPECIFICACIONES

 ALLOY 6061 HYDROFORMED

 ALLOY 386 80mm

 SHIMANO TX35 21s

 SHIMANO TZ30

 MEGAMO 920 42-32-22 T

 SHIMANO EF41

 SHIMANO EF41

 ALLOY SCOUT BLACK

 26" x 1.95"

 SHIMANO TZ21 7s 14-28 T

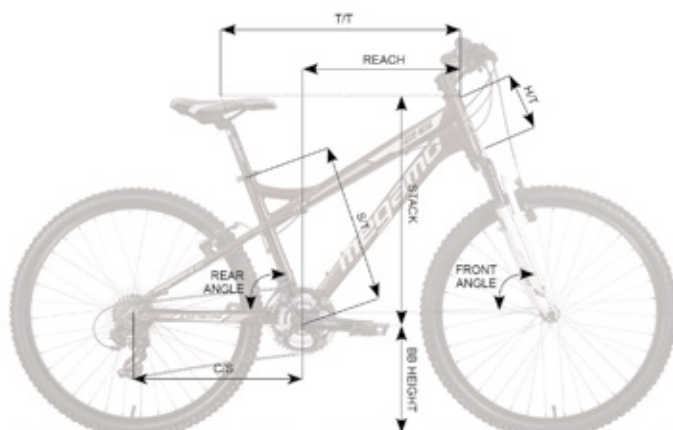

OPEN REPLICA LADY 26"

	XS	XM
SIZE	14"	16"
T/T	537	553
C/S	435	435
S/T	360	400
H/T	150	150
FRONT ANGLE	71°	72°
REAR ANGLE	71°	72°

24 OPEN JUNIOR BOY ORANGE / YELLOW

24 OPEN JUNIOR BOY
ORANGE



24 OPEN JUNIOR BOY
YELLOW



SPECIFICATIONS / ESPECIFICACIONES

 ALLOY 6061 HYDROFORMED

 ALLOY 386 80mm

 SHIMANO TX35 21s

 SHIMANO TZ30

 MEGAMO 926 42-32-22 T

 SHIMANO EF41

 SHIMANO EF41

 ALLOY SCOUT BLACK

 24" x 1.95"

 SHIMANO TZ21 7s 14-28 T

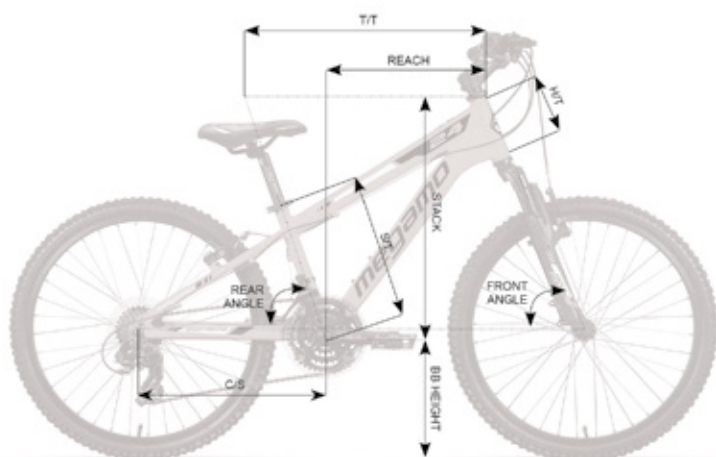

OPEN JUNIOR BOY

24"

SIZE	onesize
T/T	496
C/S	410
S/T	310
H/T	145
FRONT ANGLE	71°
REAR ANGLE	73°

24 OPEN JUNIOR GIRL WHITE / GREEN

**24 OPEN JUNIOR GIRL
WHITE**



**24 OPEN JUNIOR GIRL
GREEN**



SPECIFICATIONS / ESPECIFICACIONES

 ALLOY 6061 HYDROFORMED

 ALLOY 386 80mm

 SHIMANO TX35 21s

 SHIMANO TZ30

 MEGAMO 926 42-32-22 T

 SHIMANO EF41

 SHIMANO EF41

 ALLOY SCOUT BLACK

 24" x 1.95"

 SHIMANO TZ21 7s 14-28 T

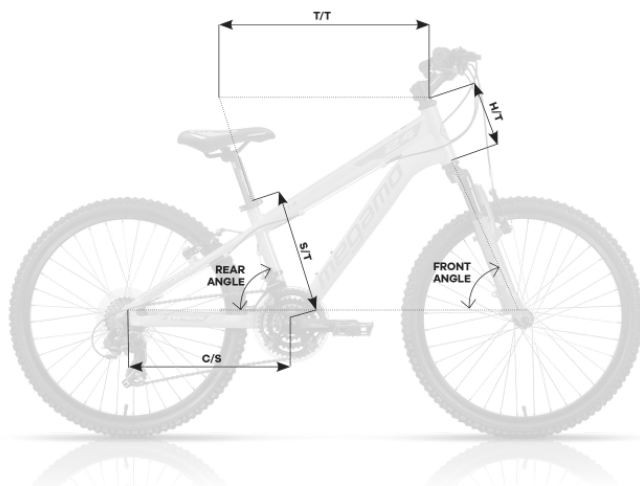

OPEN JUNIOR GIRL

24"

	onesize
SIZE	12"
T/T	496
C/S	410
S/T	310
H/T	145
FRONT ANGLE	71°
REAR ANGLE	73°



WEAR/ROPA

KIDS BMX

CITY

TREKKING

FAT

ROAD

MTB

E-BIKES





megamo

ROAD

RACE SERIES

PULSE ELITE DISC 01 YELLOW / GREEN / GREY.....	160-162
PULSE ELITE DISC 03 YELLOW / GREEN / GREY.....	163-165
PULSE ELITE DISC 05 YELLOW / GREEN / GREY.....	166-168
PULSE ELITE DISC 10 YELLOW / GREEN / GREY.....	169-171
PULSE ELITE DISC 20 YELLOW / GREEN / GREY.....	172-175
PULSE ELITE 01 YELLOW / GREEN / GREY.....	178-180
PULSE ELITE 03 YELLOW / GREEN / GREY.....	181-183
PULSE ELITE 05 YELLOW / GREEN / GREY.....	184-186
PULSE ELITE 10 YELLOW / GREEN / GREY.....	187-189
PULSE ELITE 20 YELLOW / GREEN / GREY.....	190-193

LIGHTWEIGHT

RAISE 03 YELLOW / GREEN / GREY.....	196-198
RAISE 05 YELLOW / GREEN / GREY.....	199-201
RAISE 10 YELLOW / GREEN / GREY.....	202-204
RAISE 20 YELLOW / GREEN / GREY.....	205-207
CORE 03 YELLOW / GREEN / GREY.....	210-212
CORE 05 YELLOW / GREEN / GREY.....	213-215
CORE 10 YELLOW / GREEN / GREY.....	216-218
CORE 20 YELLOW / GREEN / GREY.....	219-221
CORE 30 YELLOW / GREEN / GREY.....	222-225

ENDURANCE

R10 105 ORANGE / GREY / GREEN.....	226-228
R10 TIAGRA ORANGE / GREY / GREEN.....	229-231

GRAVE

GRAVE 10 ORANGE / BLACK.....	234-235
GRAVE 20 ORANGE / BLACK.....	236-237

PULSE ELITE DISC



It is not an ordinary bicycle. Without dudes, this is the most advanced technology, speed and sensations on a bike that will not leave you indifferent. Pulse Elite Disc combines the aerodynamic qualities that let you move along with less resistance, with the commodity that will allow you to ride more kilometres with less fatigue and, of course, an excellent weight / rigidity ratio The internal cable routing and cockpit reach a unique aesthetic shape. The disk brakes are integrated on the frame securing maximum stiffness and braking power.

No se trata de otra bicicleta cualquiera. Es sin duda la culminación del rendimiento, velocidad y sensaciones plasmada en una montura que no te dejará indiferente. Pulse Elite Disc combina la aerodinámica que permite avanzar con menos resistencia, con la comodidad de una bicicleta que permitirá recorrer más kilómetros con menos fatiga y, por supuesto, una relación peso/rigidez excelente... Una estética única con todo el cableado interno y manillar/potencia integrados. Los frenos de disco se integran en el cuadro para pasar desapercibidos asegurando máxima rigidez y potencia de frenado.



FULL INTERNAL CABLE ROUTING

From the headset up to dropouts, the cables still unnoticed and inside the frame and handlebar. We reach a very clear and futuristic looking.

CABLEADO TOTALMENTE INTERNO

Desde la pipa delantera hasta las punteras, el cableado permanece escondido a la vista. El aspecto conseguido es limpio y futurista.

THRU AXLES

Frame has thru axles in both wheels, to transmit directly the forces.

EJES PASANTES

Cuenta con ejes pasantes en ambas ruedas, para transmitir de forma directa las fuerzas.



DI2 INTEGRATED INSIDE THE FRAME

Integrated devices of Di2 inside frame. No more visible cables or clamps.

CENTRAL DI2 INTEGRADA

El cuadro está pensado para integrar los dispositivos del Di2 dentro del cuadro. Adiós a los cables visibles y abrazaderas.

GEOMETRY

The geometry and cockpit of Pulse Elite Disc allow to handle the bike on an ideal position. Speed, reactions and commodity are combined.

GEOMETRÍA









El puesto de conducción de la Pulse Elite Disc permite un control sobre la bicicleta soberbio. Velocidad, reacciones y comodidad combinadas.



PULSE ELITE DISC 01 YELLOW



SPECIFICATIONS / ESPECIFICACIONES

-  CARBON ULTRA-LIGHT ADVANCED COMPOSITE FRAME, FULL INTERNAL CABLE ROUTING, FLAT MOUNT DISC 12x142
-  CARBON ULTRA-LIGHT DISC FORK, FULL INTERNAL CABLE ROUTING, FLAT MOUNT DISC 12x100
-  INTEGRATED INTERNAL ROUTING
-  CARBON FULL INTEGRATED INTERNAL ROUTING
-  AERODINAMIC ADVANCED CARBON SEATPOST
-  SELLE ITALIA SLR CARBON RAIL
-  SHIMANO DURA-ACE Di2 9150 11s
-  SHIMANO DURA-ACE 9100 11s 52-36T
-  SHIMANO DURA-ACE Di2 9170 11s

-  SHIMANO DURA-ACE Di2 9170 11s HYDRAULIC DISC
-  VISION METRON 40 DISC
-  VISION METRON 40 DISC
-  VITTORIA CORSA 700x25C BROWN SIDE
-  SHIMANO DURA-ACE 9100 11s 11-30T

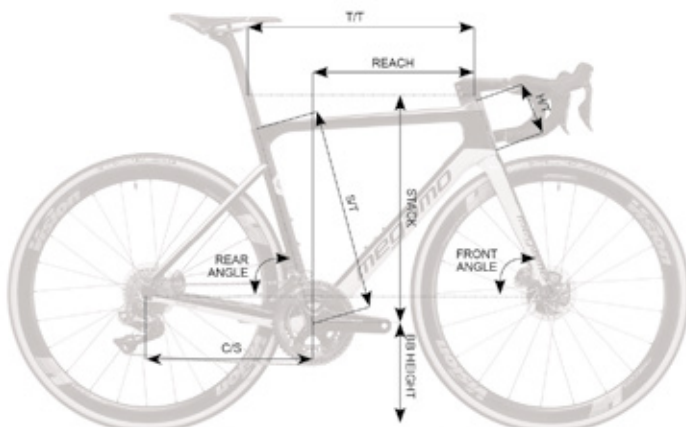

PULSE ELITE DISC 01

	XS	S	M	L	XL
SIZE	-	-	-	-	-
T/T	510	522	541	562	584
C/S	405	405	405	408	408
S/T	450	480	500	520	540
H/T	105	120	138	155	175
REACH	371	374	387	398	409
STACK	500	515	536	554	573
BB HEIGHT	285	285	285	285	285
FRONT ANGLE	71,5	71,5	72,5	73	73
REAR ANGLE	74,5	74	74	73,5	73,5

PULSE ELITE DISC 01 GREEN

E-BIKES

MTB

ROAD

FAT

TREKKING















CITY

KIDS BMX

WEAR/ROPA



SPECIFICATIONS / ESPECIFICACIONES

-  CARBON ULTRA-LIGHT ADVANCED COMPOSITE FRAME, FULL INTERNAL CABLE ROUTING, FLAT MOUNT DISC 12x142
-  CARBON ULTRA-LIGHT DISC FORK, FULL INTERNAL CABLE ROUTING, FLAT MOUNT DISC 12x100
-  INTEGRATED INTERNAL ROUTING
-  CARBON FULL INTEGRATED INTERNAL ROUTING
-  AERODINAMIC ADVANCED CARBON SEATPOST
-  SELLE ITALIA SLR CARBON RAIL
-  SHIMANO DURA-ACE Di2 9150 11s
-  SHIMANO DURA-ACE 9100 11s 52-36T
-  SHIMANO DURA-ACE Di2 9170 11s
-  SHIMANO DURA-ACE Di2 9170 11s HYDRAULIC DISC
-  VISION METRON 40 DISC
-  VISION METRON 40 DISC
-  VITTORIA CORSA 700x25C BROWN SIDE
-  SHIMANO DURA-ACE 9100 11s 11-30T

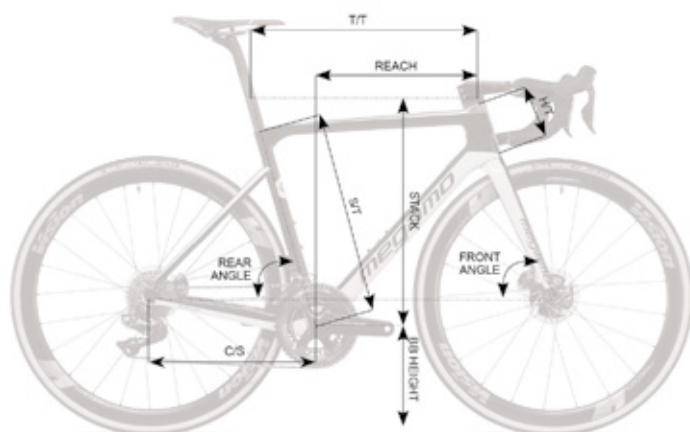















PULSE ELITE DISC 01

	XS	S	M	L	XL
SIZE	-	-	-	-	-
T/T	510	522	541	562	584
C/S	405	405	405	408	408
S/T	450	480	500	520	540
H/T	105	120	138	155	175
REACH	371	374	387	398	409
STACK	500	515	536	554	573
BB HEIGHT	285	285	285	285	285
FRONT ANGLE	71,5	71,5	72,5	73	73
REAR ANGLE	74,5	74	74	73,5	73,5

PULSE ELITE DISC 01 GREY



SPECIFICATIONS / ESPECIFICACIONES

-  CARBON ULTRA-LIGHT ADVANCED COMPOSITE FRAME, FULL INTERNAL CABLE ROUTING, FLAT MOUNT DISC 12x142
-  CARBON ULTRA-LIGHT DISC FORK, FULL INTERNAL CABLE ROUTING, FLAT MOUNT DISC 12x100
-  INTEGRATED INTERNAL ROUTING
-  CARBON FULL INTEGRATED INTERNAL ROUTING
-  AERODINAMIC ADVANCED CARBON SEATPOST
-  SELLE ITALIA SLR CARBON RAIL
-  SHIMANO DURA-ACE Di2 9150 11s
-  SHIMANO DURA-ACE 9100 11s 52-36T
-  SHIMANO DURA-ACE Di2 9170 11s
-  SHIMANO DURA-ACE Di2 9170 11s HYDRAULIC DISC
-  VISION METRON 40 DISC
-  VISION METRON 40 DISC
-  VITTORIA CORSA 700x25C BROWN SIDE
-  SHIMANO DURA-ACE 9100 11s 11-30T

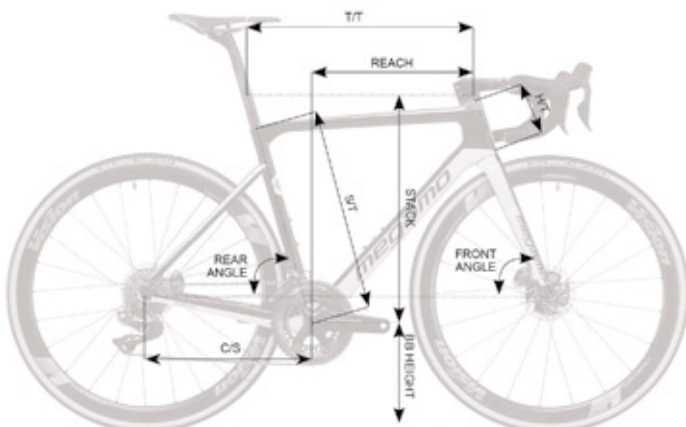

PULSE ELITE DISC 01

	XS	S	M	L	XL
SIZE	-	-	-	-	-
T/T	510	522	541	562	584
C/S	405	405	405	408	408
S/T	450	480	500	520	540
H/T	105	120	138	155	175
REACH	371	374	387	398	409
STACK	500	515	536	554	573
BB HEIGHT	285	285	285	285	285
FRONT ANGLE	71,5	71,5	72,5	73	73
REAR ANGLE	74,5	74	74	73,5	73,5

PULSE ELITE DISC 03 YELLOW

E-BIKES

MTB

ROAD

FAT

TREKKING











CITY

KIDS BMX

WEAR/ROPA



SPECIFICATIONS / ESPECIFICACIONES

-  CARBON ADVANCED COMPOSITE FRAME, FULL INTERNAL CABLE ROUTING, FLAT MOUNT DISC 12x142
-  CARBON DISC FORK, FULL INTERNAL CABLE ROUTING, FLAT MOUNT DISC 12x100
-  INTEGRATED INTERNAL ROUTING
-  CARBON FULL INTEGRATED INTERNAL ROUTING
-  AERODINAMIC ADVANCED CARBON SEATPOST
-  SELLE ITALIA SLR TITANIUM RAIL
-  SHIMANO ULTEGRA Di2 8050 11s
-  SHIMANO ULTEGRA Di2 8050 11s
-  SHIMANO ULTEGRA 8000 11s 52-36T
-  SHIMANO ULTEGRA Di2 8070 11s

-  SHIMANO ULTEGRA Di2 8070 11s HYDRAULIC DISC
-  VISION METRON 40 DISC
-  VISION METRON 40 DISC
-  VITTORIA CORSA 700x25C BROWN SIDE
-  SHIMANO ULTEGRA 8000 11s 11-30T

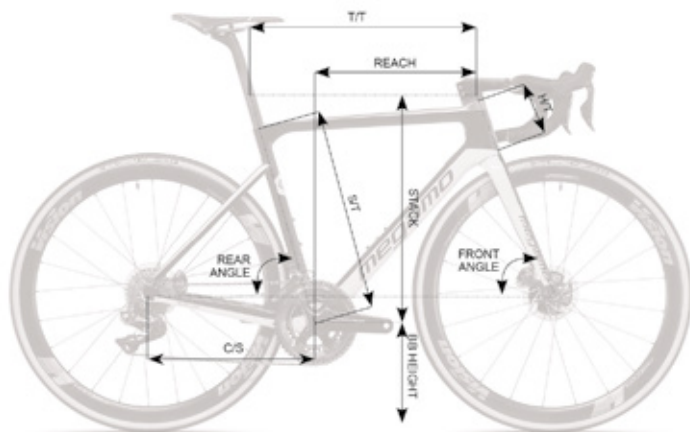











PULSE ELITE DISC 03

	XS	S	M	L	XL
SIZE	-	-	-	-	-
T/T	510	522	541	562	584
C/S	405	405	405	408	408
S/T	450	480	500	520	540
H/T	105	120	138	155	175
REACH	371	374	387	398	409
STACK	500	515	536	554	573
BB HEIGHT	285	285	285	285	285
FRONT ANGLE	71,5	71,5	72,5	73	73
REAR ANGLE	74,5	74	74	73,5	73,5

PULSE ELITE DISC 03 GREEN



SPECIFICATIONS / ESPECIFICACIONES

-  CARBON ADVANCED COMPOSITE FRAME, FULL INTERNAL CABLE ROUTING, FLAT MOUNT DISC 12x142
-  CARBON DISC FORK, FULL INTERNAL CABLE ROUTING, FLAT MOUNT DISC 12x100
-  INTEGRATED INTERNAL ROUTING
-  CARBON FULL INTEGRATED INTERNAL ROUTING
-  AERODINAMIC ADVANCED CARBON SEATPOST
-  SELLE ITALIA SLR TITANIUM RAIL
-  SHIMANO ULTEGRA Di2 8050 11s
-  SHIMANO ULTEGRA Di2 8050 11s
-  SHIMANO ULTEGRA 8000 11s 52-36T
-  SHIMANO ULTEGRA Di2 8070 11s

-  SHIMANO ULTEGRA Di2 8070 11s HYDRAULIC DISC
-  VISION METRON 40 DISC
-  VISION METRON 40 DISC
-  VITTORIA CORSA 700x25C BROWN SIDE
-  SHIMANO ULTEGRA 8000 11s 11-30T

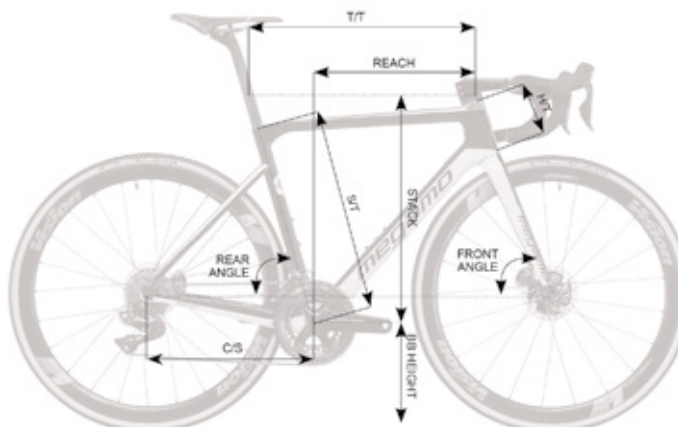

PULSE ELITE DISC 03

	XS	S	M	L	XL
SIZE	-	-	-	-	-
T/T	510	522	541	562	584
C/S	405	405	405	408	408
S/T	450	480	500	520	540
H/T	105	120	138	155	175
REACH	371	374	387	398	409
STACK	500	515	536	554	573
BB HEIGHT	285	285	285	285	285
FRONT ANGLE	71,5	71,5	72,5	73	73
REAR ANGLE	74,5	74	74	73,5	73,5

PULSE ELITE DISC 03 GREY

E-BIKES

MTB

ROAD

FAT

TREKKING











CITY

KIDS BMX

WEAR/ROPA



SPECIFICATIONS / ESPECIFICACIONES

-  CARBON ADVANCED COMPOSITE FRAME, FULL INTERNAL CABLE ROUTING, FLAT MOUNT DISC 12x142
-  CARBON DISC FORK, FULL INTERNAL CABLE ROUTING, FLAT MOUNT DISC 12x100
-  INTEGRATED INTERNAL ROUTING
-  CARBON FULL INTEGRATED INTERNAL ROUTING
-  AERODINAMIC ADVANCED CARBON SEATPOST
-  SELLE ITALIA SLR TITANIUM RAIL
-  SHIMANO ULTEGRA Di2 8050 11s
-  SHIMANO ULTEGRA Di2 8050 11s
-  SHIMANO ULTEGRA 8000 11s 52-36T
-  SHIMANO ULTEGRA Di2 8070 11s

-  SHIMANO ULTEGRA Di2 8070 11s HYDRAULIC DISC
-  VISION METRON 40 DISC
-  VISION METRON 40 DISC
-  VITTORIA CORSA 700x25C BROWN SIDE
-  SHIMANO ULTEGRA 8000 11s 11-30T

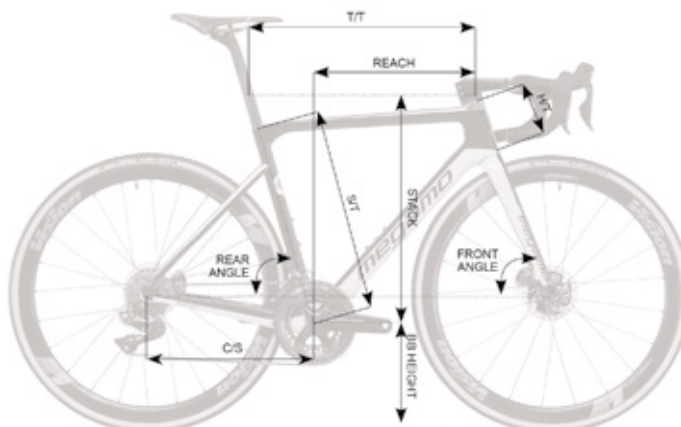









PULSE ELITE DISC 03

	XS	S	M	L	XL
SIZE	-	-	-	-	-
T/T	510	522	541	562	584
C/S	405	405	405	408	408
S/T	450	480	500	520	540
H/T	105	120	138	155	175
REACH	371	374	387	398	409
STACK	500	515	536	554	573
BB HEIGHT	285	285	285	285	285
FRONT ANGLE	71,5	71,5	72,5	73	73
REAR ANGLE	74,5	74	74	73,5	73,5

PULSE ELITE DISC 05 YELLOW



SPECIFICATIONS / ESPECIFICACIONES

-  CARBON ADVANCED COMPOSITE FRAME, FULL INTERNAL CABLE ROUTING, FLAT MOUNT DISC 12x142
-  CARBON DISC FORK, FULL INTERNAL CABLE ROUTING, FLAT MOUNT DISC 12x100
-  INTEGRATED INTERNAL ROUTING
-  CARBON FULL INTEGRATED INTERNAL ROUTING
-  AERODINAMIC ADVANCED CARBON SEATPOST
-  SELLE ITALIA SLR
-  SHIMANO ULTEGRA Di2 8050 11s
-  SHIMANO ULTEGRA 8000 11s 52-36T
-  SHIMANO ULTEGRA Di2 8070 11s

-  SHIMANO ULTEGRA Di2 8070 11s HYDRAULIC DISC
-  VISION TEAM 30 DISC 12x100 / 12x142
-  VISION TEAM 30 DISC
-  VITTORIA RUBINO 700x25C
-  SHIMANO ULTEGRA 8000 11s 11-30T

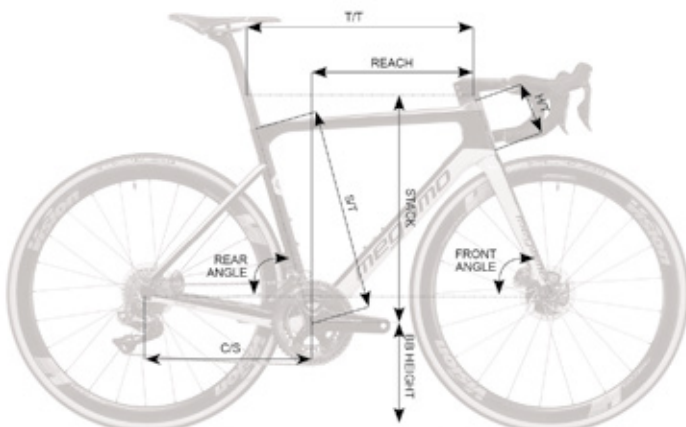

PULSE ELITE DISC 05

	XS	S	M	L	XL
SIZE	-	-	-	-	-
T/T	510	522	541	562	584
C/S	405	405	405	408	408
S/T	450	480	500	520	540
H/T	105	120	138	155	175
REACH	371	374	387	398	409
STACK	500	515	536	554	573
BB HEIGHT	285	285	285	285	285
FRONT ANGLE	71,5	71,5	72,5	73	73
REAR ANGLE	74,5	74	74	73,5	73,5

PULSE ELITE DISC 05 GREEN

E-BIKES

MTB

ROAD

FAT

TREKKING









CITY

KIDS BMX

WEAR/ROPA



SPECIFICATIONS / ESPECIFICACIONES

-  CARBON ADVANCED COMPOSITE FRAME, FULL INTERNAL CABLE ROUTING, FLAT MOUNT DISC 12x142
-  CARBON DISC FORK, FULL INTERNAL CABLE ROUTING, FLAT MOUNT DISC 12x100
-  INTEGRATED INTERNAL ROUTING
-  CARBON FULL INTEGRATED INTERNAL ROUTING
-  AERODINAMIC ADVANCED CARBON SEATPOST
-  SELLE ITALIA SLR
-  SHIMANO ULTEGRA DI2 8050 11s
-  SHIMANO ULTEGRA 8000 11s 52-36T
-  SHIMANO ULTEGRA DI2 8070 11s

-  SHIMANO ULTEGRA DI2 8070 11s HYDRAULIC DISC
-  VISION TEAM 30 DISC 12x100 / 12x142
-  VISION TEAM 30 DISC
-  VITTORIA RUBINO 700x25C
-  SHIMANO ULTEGRA 8000 11s 11-30T

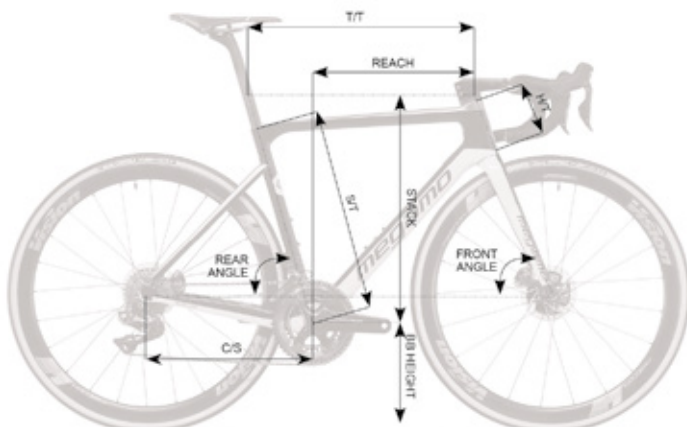















PULSE ELITE DISC 05

	XS	S	M	L	XL
SIZE	-	-	-	-	-
T/T	510	522	541	562	584
C/S	405	405	405	408	408
S/T	450	480	500	520	540
H/T	105	120	138	155	175
REACH	371	374	387	398	409
STACK	500	515	536	554	573
BB HEIGHT	285	285	285	285	285
FRONT ANGLE	71,5	71,5	72,5	73	73
REAR ANGLE	74,5	74	74	73,5	73,5

PULSE ELITE DISC 05 GREY



SPECIFICATIONS / ESPECIFICACIONES

-  CARBON ADVANCED COMPOSITE FRAME, FULL INTERNAL CABLE ROUTING, FLAT MOUNT DISC 12x142
-  CARBON DISC FORK, FULL INTERNAL CABLE ROUTING, FLAT MOUNT DISC 12x100
-  INTEGRATED INTERNAL ROUTING
-  CARBON FULL INTEGRATED INTERNAL ROUTING
-  AERODINAMIC ADVANCED CARBON SEATPOST
-  SELLE ITALIA SLR
-  SHIMANO ULTEGRA Di2 8050 11s
-  SHIMANO ULTEGRA 8000 11s 52-36T
-  SHIMANO ULTEGRA Di2 8070 11s
-  SHIMANO ULTEGRA Di2 8070 11s HYDRAULIC DISC
-  VISION TEAM 30 DISC 12x100 / 12x142
-  VISION TEAM 30 DISC
-  VITTORIA RUBINO 700x25C
-  SHIMANO ULTEGRA 8000 11s 11-30T

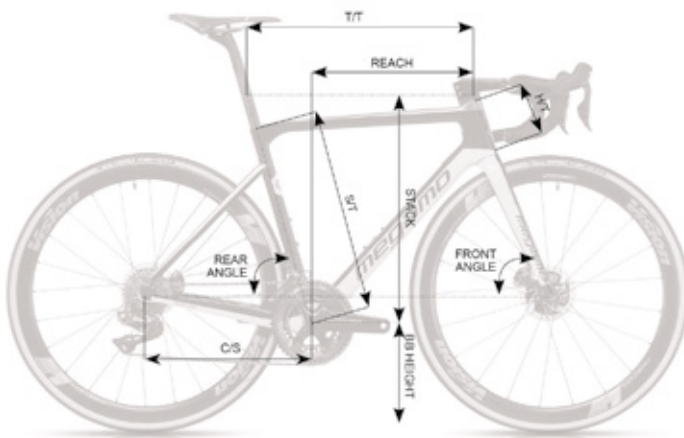

PULSE ELITE DISC 05

	XS	S	M	L	XL
SIZE	-	-	-	-	-
T/T	510	522	541	562	584
C/S	405	405	405	408	408
S/T	450	480	500	520	540
H/T	105	120	138	155	175
REACH	371	374	387	398	409
STACK	500	515	536	554	573
BB HEIGHT	285	285	285	285	285
FRONT ANGLE	71,5	71,5	72,5	73	73
REAR ANGLE	74,5	74	74	73,5	73,5

PULSE ELITE DISC 10 YELLOW

E-BIKES

MTB

ROAD

FAT

TREKKING











CITY

KIDS BMX

WEAR/ROPA



SPECIFICATIONS / ESPECIFICACIONES

-  CARBON ADVANCED COMPOSITE FRAME, FULL INTERNAL CABLE ROUTING, FLAT MOUNT DISC 12x142
-  CARBON DISC FORK, FULL INTERNAL CABLE ROUTING, FLAT MOUNT DISC 12x100
-  INTEGRATED INTERNAL ROUTING
-  CARBON FULL INTEGRATED INTERNAL ROUTING
-  AERODINAMIC ADVANCED CARBON SEATPOST
-  SELLE ITALIA SLR
-  SHIMANO ULTEGRA 8000 11s
-  SHIMANO ULTEGRA 8000 11s
-  SHIMANO ULTEGRA 8000 11s 52-36T
-  SHIMANO ULTEGRA 8020 11s

-  SHIMANO ULTEGRA 8070 11s HYDRAULIC DISC
-  VISION TEAM 30 DISC 12x100 / 12x142
-  VISION TEAM 30 DISC
-  VITTORIA RUBINO 700x25C
-  SHIMANO ULTEGRA 8000 11s 11-30T

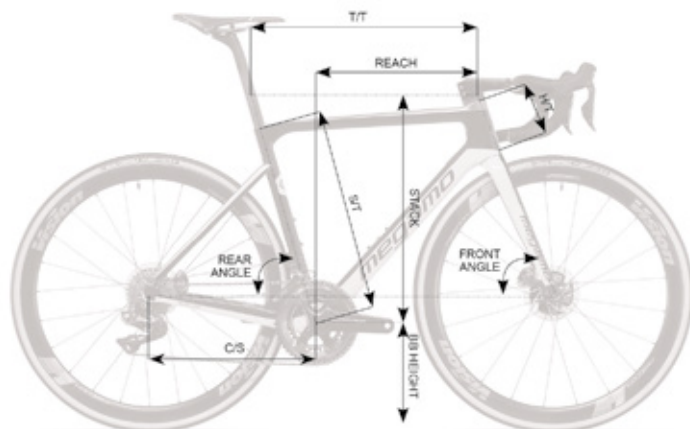











PULSE ELITE DISC 10

	XS	S	M	L	XL
SIZE	-	-	-	-	-
T/T	510	522	541	562	584
C/S	405	405	405	408	408
S/T	450	480	500	520	540
H/T	105	120	138	155	175
REACH	371	374	387	398	409
STACK	500	515	536	554	573
BB HEIGHT	285	285	285	285	285
FRONT ANGLE	71,5	71,5	72,5	73	73
REAR ANGLE	74,5	74	74	73,5	73,5

PULSE ELITE DISC 10 GREEN



SPECIFICATIONS / ESPECIFICACIONES

-  CARBON ADVANCED COMPOSITE FRAME, FULL INTERNAL CABLE ROUTING, FLAT MOUNT DISC 12x142
-  CARBON DISC FORK, FULL INTERNAL CABLE ROUTING, FLAT MOUNT DISC 12x100
-  INTEGRATED INTERNAL ROUTING
-  CARBON FULL INTEGRATED INTERNAL ROUTING
-  AERODINAMIC ADVANCED CARBON SEATPOST
-  SELLE ITALIA SLR
-  SHIMANO ULTEGRA 8000 11s
-  SHIMANO ULTEGRA 8000 11s
-  SHIMANO ULTEGRA 8000 11s 52-36T
-  SHIMANO ULTEGRA 8020 11s

-  SHIMANO ULTEGRA 8070 11s HYDRAULIC DISC
-  VISION TEAM 30 DISC 12x100 / 12x142
-  VISION TEAM 30 DISC
-  VITTORIA RUBINO 700x25C
-  SHIMANO ULTEGRA 8000 11s 11-30T

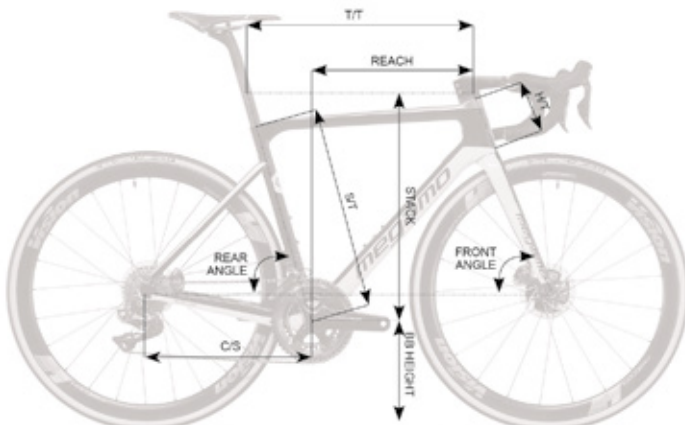

PULSE ELITE DISC 10

	XS	S	M	L	XL
SIZE	-	-	-	-	-
T/T	510	522	541	562	584
C/S	405	405	405	408	408
S/T	450	480	500	520	540
H/T	105	120	138	155	175
REACH	371	374	387	398	409
STACK	500	515	536	554	573
BB HEIGHT	285	285	285	285	285
FRONT ANGLE	71,5	71,5	72,5	73	73
REAR ANGLE	74,5	74	74	73,5	73,5

PULSE ELITE DISC 10 GREY

E-BIKES

MTB

ROAD

FAT

TREKKING











CITY

KIDS BMX

WEAR/ROPA



SPECIFICATIONS / ESPECIFICACIONES

-  CARBON ADVANCED COMPOSITE FRAME, FULL INTERNAL CABLE ROUTING, FLAT MOUNT DISC 12x142
-  CARBON DISC FORK, FULL INTERNAL CABLE ROUTING, FLAT MOUNT DISC 12x100
-  INTEGRATED INTERNAL ROUTING
-  CARBON FULL INTEGRATED INTERNAL ROUTING
-  AERODINAMIC ADVANCED CARBON SEATPOST
-  SELLE ITALIA SLR
-  SHIMANO ULTEGRA 8000 11s
-  SHIMANO ULTEGRA 8000 11s
-  SHIMANO ULTEGRA 8000 11s 52-36T
-  SHIMANO ULTEGRA 8020 11s

-  SHIMANO ULTEGRA 8070 11s HYDRAULIC DISC
-  VISION TEAM 30 DISC 12x100 / 12x142
-  VISION TEAM 30 DISC
-  VITTORIA RUBINO 700x25C
-  SHIMANO ULTEGRA 8000 11s 11-30T

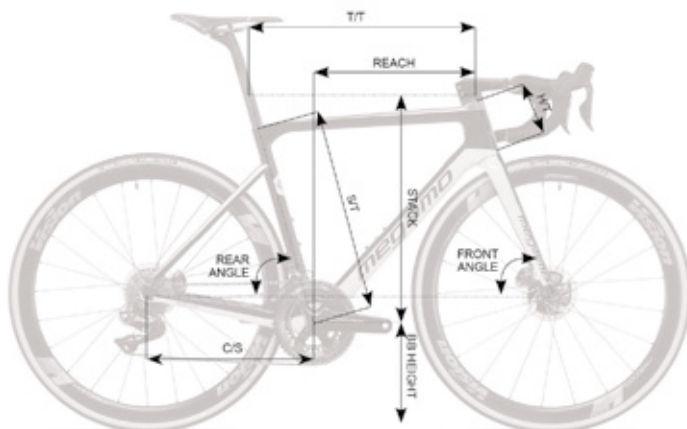















PULSE ELITE DISC 10

	XS	S	M	L	XL
SIZE	-	-	-	-	-
T/T	510	522	541	562	584
C/S	405	405	405	408	408
S/T	450	480	500	520	540
H/T	105	120	138	155	175
REACH	371	374	387	398	409
STACK	500	515	536	554	573
BB HEIGHT	285	285	285	285	285
FRONT ANGLE	71,5	71,5	72,5	73	73
REAR ANGLE	74,5	74	74	73,5	73,5

PULSE ELITE DISC 20 YELLOW



SPECIFICATIONS / ESPECIFICACIONES

	CARBON ADVANCED COMPOSITE FRAME, FULL INTERNAL CABLE ROUTING, FLAT MOUNT DISC 12x142		SHIMANO 105 7070 11s HYDRAULIC DISC
	CARBON DISC FORK, FULL INTERNAL CABLE ROUTING, FLAT MOUNT DISC 12x100		VISION TEAM 30 DISC
	INTEGRATED INTERNAL ROUTING		VISION TEAM 30 DISC
	CARBON FULL INTEGRATED INTERNAL ROUTING		VITTORIA RUBINO 700x25C
	AERODINAMIC ADVANCED CARBON SEATPOST		SHIMANO 105 7000 11-30T 11s
	SELLE ITALIA SLR		
	SHIMANO 105 7000 11s		
	SHIMANO 105 7000 11s		
	SHIMANO 105 7000 11s 50/34T		
	SHIMANO 105 7020 11s		

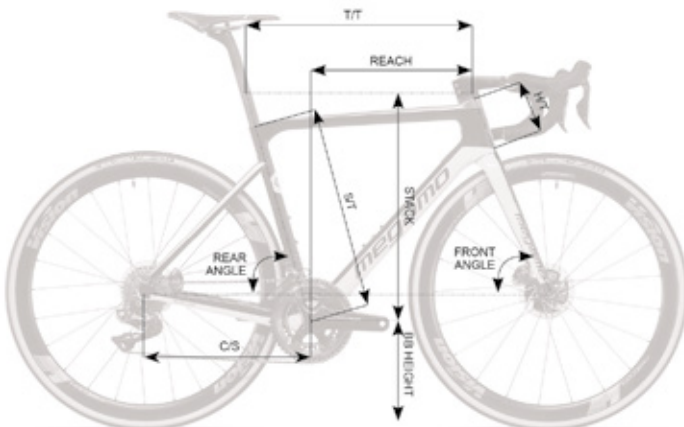

PULSE ELITE DISC 20

	XS	S	M	L	XL
SIZE	-	-	-	-	-
T/T	510	522	541	562	584
C/S	405	405	405	408	408
S/T	450	480	500	520	540
H/T	105	120	138	155	175
REACH	371	374	387	398	409
STACK	500	515	536	554	573
BB HEIGHT	285	285	285	285	285
FRONT ANGLE	71,5	71,5	72,5	73	73
REAR ANGLE	74,5	74	74	73,5	73,5

PULSE ELITE DISC 20 GREEN

E-BIKES

MTB

ROAD

FAT

TREKKING











CITY

KIDS BMX

WEAR/ROPA



SPECIFICATIONS / ESPECIFICACIONES

-  CARBON ADVANCED COMPOSITE FRAME, FULL INTERNAL CABLE ROUTING, FLAT MOUNT DISC 12x142
-  CARBON DISC FORK, FULL INTERNAL CABLE ROUTING, FLAT MOUNT DISC 12x100
-  INTEGRATED INTERNAL ROUTING
-  CARBON FULL INTEGRATED INTERNAL ROUTING
-  AERODINAMIC ADVANCED CARBON SEATPOST
-  SELLE ITALIA SLR
-  SHIMANO 105 7000 11s
-  SHIMANO 105 7000 11s
-  SHIMANO 105 7000 11s 50/34T
-  SHIMANO 105 7020 11s

-  SHIMANO 105 7070 11s HYDRAULIC DISC
-  VISION TEAM 30 DISC
-  VISION TEAM 30 DISC
-  VITTORIA RUBINO 700x25C
-  SHIMANO 105 7000 11-30T 11s

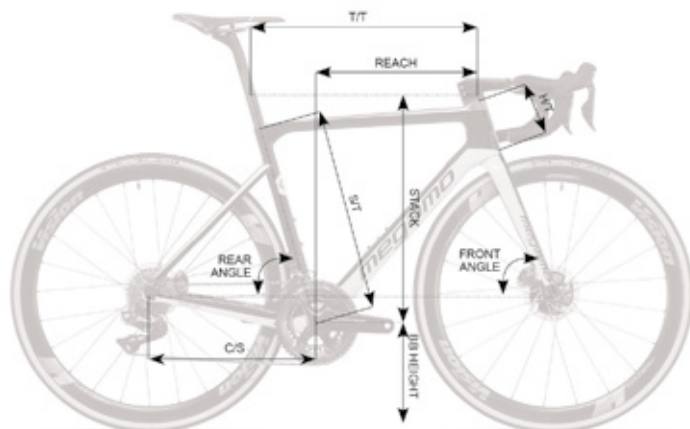















PULSE ELITE DISC 20

	XS	S	M	L	XL
SIZE	-	-	-	-	-
T/T	510	522	541	562	584
C/S	405	405	405	408	408
S/T	450	480	500	520	540
H/T	105	120	138	155	175
REACH	371	374	387	398	409
STACK	500	515	536	554	573
BB HEIGHT	285	285	285	285	285
FRONT ANGLE	71,5	71,5	72,5	73	73
REAR ANGLE	74,5	74	74	73,5	73,5

PULSE ELITE DISC 20 GREY



SPECIFICATIONS / ESPECIFICACIONES

	CARBON ADVANCED COMPOSITE FRAME, FULL INTERNAL CABLE ROUTING, FLAT MOUNT DISC 12x142		SHIMANO 105 7070 11s HYDRAULIC DISC
	CARBON DISC FORK, FULL INTERNAL CABLE ROUTING, FLAT MOUNT DISC 12x100		VISION TEAM 30 DISC
	INTEGRATED INTERNAL ROUTING		VISION TEAM 30 DISC
	CARBON FULL INTEGRATED INTERNAL ROUTING		VITTORIA RUBINO 700x25C
	AERODINAMIC ADVANCED CARBON SEATPOST		SHIMANO 105 7000 11-30T 11s
	SELLE ITALIA SLR		
	SHIMANO 105 7000 11s		
	SHIMANO 105 7000 11s		
	SHIMANO 105 7000 11s 50/34T		
	SHIMANO 105 7020 11s		

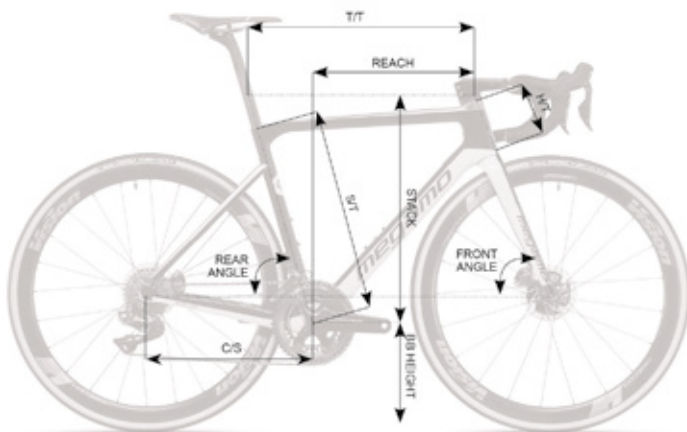

PULSE ELITE DISC 20

	XS	S	M	L	XL
SIZE	-	-	-	-	-
T/T	510	522	541	562	584
C/S	405	405	405	408	408
S/T	450	480	500	520	540
H/T	105	120	138	155	175
REACH	371	374	387	398	409
STACK	500	515	536	554	573
BB HEIGHT	285	285	285	285	285
FRONT ANGLE	71,5	71,5	72,5	73	73
REAR ANGLE	74,5	74	74	73,5	73,5



WEAR/ROPA

KIDS BMX

CITY

TREKKING

FAT

ROAD

MTB

E-BIKES

PULSE ELITE



It is not an ordinary bicycle. Without dudes, this is the most advanced technology, speed and sensations on a bike that will not leave you indifferent. Pulse Elite combines the aerodynamic qualities that let you move along with less resistance, with the commodity that will allow you to ride more kilometres with less fatigue and, of course, an excellent weight / rigidity ratio The internal cable routing and cockpit reach a unique aesthetic shape. Direct mount are integrated on the frame securing maximum stiffness and braking power.

No se trata de otra bicicleta cualquiera. Es sin duda la culminación del rendimiento, velocidad y sensaciones plasmada en una montura que no te dejará indiferente. Pulse Elite combina la aerodinámica que permite avanzar con menos resistencia, con la comodidad de una bicicleta que permitirá recorrer más kilómetros con menos fatiga y, por supuesto, una relación peso/rigidez excelente... Una estética única con el cableado interno y manillar/potencia integrados. Los frenos Direct mount se integran en el cuadro para pasar desapercibidos asegurando máxima rigidez y potencia de frenado.



FULL INTERNAL CABLE ROUTING

From the headset up to dropouts, the cables still unnoticed and inside the frame and handlebar. We reach a very clear and futuristic looking.

CABLEADO TOTALMENTE INTERNO

Desde la pipa delantera hasta las punteras, el cableado permanece escondido a la vista. El aspecto conseguido es limpio y futurista.

GEOMETRY

The geometry and cockpit of Pulse Elite Disc allow to handle the bike on an ideal position. Speed, reactions and commodity are combined.

GEOMETRÍA

El puesto de conducción de la Pulse Elite Disc permite un control sobre la bicicleta soberbio. Velocidad, reacciones y comodidad combinadas.



DI2 INTEGRATED INSIDE THE FRAME

Integrated devices of Di2 inside frame. No more visible cables or clamps.

CENTRAL DI2 INTEGRADA

El cuadro está pensado para integrar los dispositivos del Di2 dentro del cuadro. Adiós a los cables visibles y abrazaderas.



DIRECT MOUNT RIM BRAKE

Direct Mount standard has so many advantages. For example, breaking action is more efficient, and also the vibes are reduced. In addition, we save a few weight.

DIRECT MOUNT RIM BRAKE











El sistema Direct Mount aporta grandes ventajas como una mayor eficacia en la frenada, la reducción de las vibraciones en la pinza así como la disminución del peso.







PULSE ELITE 01 YELLOW



SPECIFICATIONS / ESPECIFICACIONES

-  CARBON ULTRA-LIGHT ADVANCED COMPOSITE FRAME, FULL INTERNAL CABLE ROUTING, DIRECT MOUNT BRAKE
-  CARBON ULTRA-LIGHT FORK
-  INTEGRATED INTERNAL ROUTING
-  CARBON FULL INTEGRATED INTERNAL ROUTING
-  AERODINAMIC ADVANCED CARBON SEATPOST
-  SELLE ITALIA SLR CARBON RAIL
-  SHIMANO DURA-ACE Di2 9150 11s
-  SHIMANO DURA-ACE Di2 9150 11s
-  SHIMANO DURA-ACE 9100 11s 52-36T
-  SHIMANO DURA-ACE Di2 9150 11s

-  SHIMANO DURA-ACE 9100 11s
-  VISION METRON 40
-  VISION METRON 40
-  VITTORIA CORSA 700x25C BROWN SIDE
-  SHIMANO DURA-ACE 9100 11s 11-30T

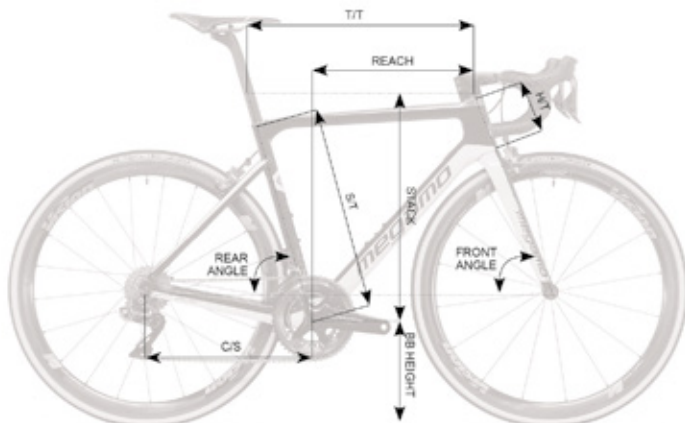

PULSE ELITE 01

	XS	S	M	L	XL
SIZE	-	-	-	-	-
T/T	510	522	541	562	584
C/S	405	405	405	408	408
S/T	450	480	500	520	540
H/T	105	120	138	155	175
REACH	371	374	387	398	409
STACK	500	515	536	554	573
BB HEIGHT	285	285	285	285	285
FRONT ANGLE	71,5	71,5	72,5	73	73
REAR ANGLE	74,5	74	74	73,5	73,5

PULSE ELITE 01 GREEN

E-BIKES

MTB

ROAD

FAT

TREKKING

CITY

KIDS BMX

WEAR/ROPA



SPECIFICATIONS / ESPECIFICACIONES

 CARBON ULTRA-LIGHT ADVANCED COMPOSITE FRAME, FULL INTERNAL CABLE ROUTING, DIRECT MOUNT BRAKE

 CARBON ULTRA-LIGHT FORK

 INTEGRATED INTERNAL ROUTING

 CARBON FULL INTEGRATED INTERNAL ROUTING

 AERODINAMIC ADVANCED CARBON SEATPOST

 SELLE ITALIA SLR CARBON RAIL

 SHIMANO DURA-ACE Di2 9150 11s

 SHIMANO DURA-ACE Di2 9150 11s

 SHIMANO DURA-ACE 9100 11s 52-36T

 SHIMANO DURA-ACE Di2 9150 11s

 SHIMANO DURA-ACE 9100 11s

 VISION METRON 40

 VISION METRON 40

 VITTORIA CORSA 700x25C BROWN SIDE

 SHIMANO DURA-ACE 9100 11s 11-30T

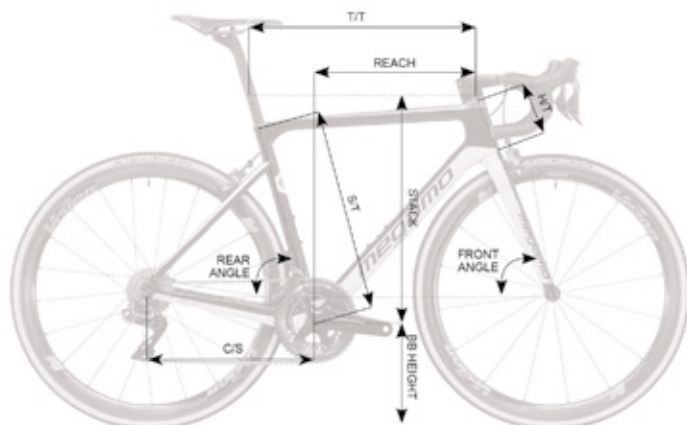











PULSE ELITE 01





	XS	S	M	L	XL
SIZE	-	-	-	-	-
T/T	510	522	541	562	584
C/S	405	405	405	408	408
S/T	450	480	500	520	540
H/T	105	120	138	155	175
REACH	371	374	387	398	409
STACK	500	515	536	554	573
BB HEIGHT	285	285	285	285	285
FRONT ANGLE	71,5	71,5	72,5	73	73
REAR ANGLE	74,5	74	74	73,5	73,5

PULSE ELITE 01 GREY



SPECIFICATIONS / ESPECIFICACIONES

-  CARBON ULTRA-LIGHT ADVANCED COMPOSITE FRAME, FULL INTERNAL CABLE ROUTING, DIRECT MOUNT BRAKE
-  CARBON ULTRA-LIGHT FORK
-  INTEGRATED INTERNAL ROUTING
-  CARBON FULL INTEGRATED INTERNAL ROUTING
-  AERODINAMIC ADVANCED CARBON SEATPOST
-  SELLE ITALIA SLR CARBON RAIL
-  SHIMANO DURA-ACE Di2 9150 11s
-  SHIMANO DURA-ACE Di2 9150 11s
-  SHIMANO DURA-ACE 9100 11s 52-36T
-  SHIMANO DURA-ACE Di2 9150 11s

-  SHIMANO DURA-ACE 9100 11s
-  VISION METRON 40
-  VISION METRON 40
-  VITTORIA CORSA 700x25C BROWN SIDE
-  SHIMANO DURA-ACE 9100 11s 11-30T

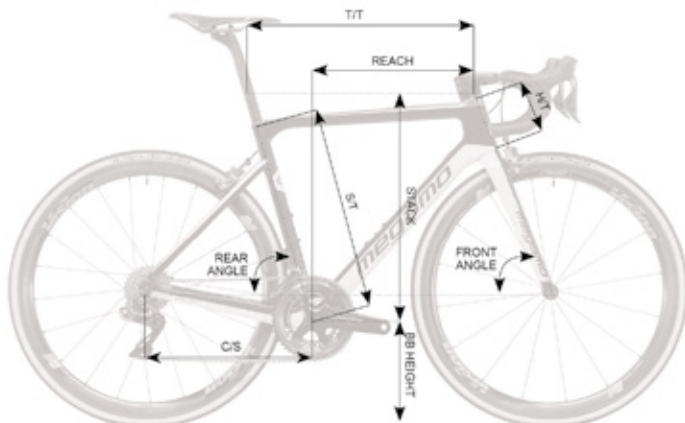

PULSE ELITE 01

	XS	S	M	L	XL
SIZE	-	-	-	-	-
T/T	510	522	541	562	584
C/S	405	405	405	408	408
S/T	450	480	500	520	540
H/T	105	120	138	155	175
REACH	371	374	387	398	409
STACK	500	515	536	554	573
BB HEIGHT	285	285	285	285	285
FRONT ANGLE	71,5	71,5	72,5	73	73
REAR ANGLE	74,5	74	74	73,5	73,5

PULSE ELITE 03 YELLOW

E-BIKES

MTB

ROAD

FAT

TREKKING











CITY

KIDS BMX

WEAR/ROPA



SPECIFICATIONS / ESPECIFICACIONES

-  CARBON ADVANCED COMPOSITE FRAME, FULL INTERNAL CABLE ROUTING, DIRECT MOUNT BRAKE
-  CARBON FORK
-  INTEGRATED INTERNAL ROUTING
-  CARBON FULL INTEGRATED INTERNAL ROUTING
-  AERODYNAMIC ADVANCED CARBON SEATPOST
-  SELLE ITALIA SLR TITANIUM RAIL
-  SHIMANO ULTEGRA Di2 8050 11s
-  SHIMANO ULTEGRA Di2 8050 11s
-  SHIMANO ULTEGRA 8000 11s 52-36T
-  SHIMANO ULTEGRA Di2 8050 11s

-  SHIMANO ULTEGRA Di2 8000 11s
-  VISION METRON 40
-  VISION METRON 40
-  VITTORIA CORSA 700x25C BROWN SIDE
-  SHIMANO DURA-ACE 9100 11s 11-30T

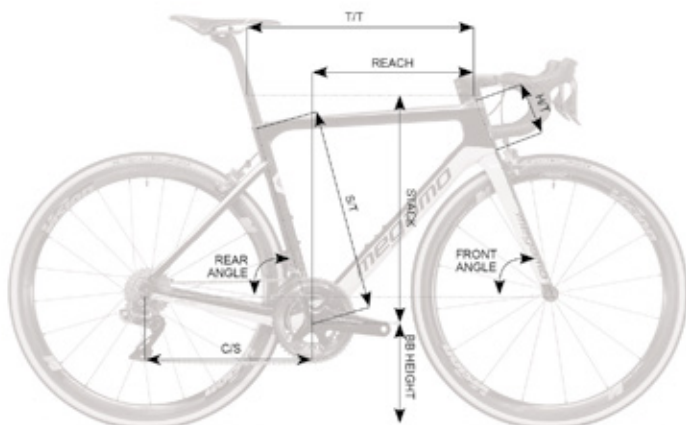

PULSE ELITE 03

	XS	S	M	L	XL
SIZE	-	-	-	-	-
T/T	510	522	541	562	584
C/S	405	405	405	408	408
S/T	450	480	500	520	540
H/T	105	120	138	155	175
REACH	371	374	387	398	409
STACK	500	515	536	554	573
BB HEIGHT	285	285	285	285	285
FRONT ANGLE	71,5	71,5	72,5	73	73
REAR ANGLE	74,5	74	74	73,5	73,5

PULSE ELITE 03 GREEN



SPECIFICATIONS / ESPECIFICACIONES

 CARBON ADVANCED COMPOSITE FRAME, FULL INTERNAL CABLE ROUTING, DIRECT MOUNT BRAKE

 CARBON FORK

 INTEGRATED INTERNAL ROUTING

 CARBON FULL INTEGRATED INTERNAL ROUTING

 AERODYNAMIC ADVANCED CARBON SEATPOST

 SELLE ITALIA SLR TITANIUM RAIL

 SHIMANO ULTEGRA Di2 8050 11s

 SHIMANO ULTEGRA Di2 8050 11s

 SHIMANO ULTEGRA 8000 11s 52-36T

 SHIMANO ULTEGRA Di2 8050 11s

 SHIMANO ULTEGRA Di2 8000 11s

 VISION METRON 40

 VISION METRON 40

 VITTORIA CORSA 700x25C BROWN SIDE

 SHIMANO DURA-ACE 9100 11s 11-30T

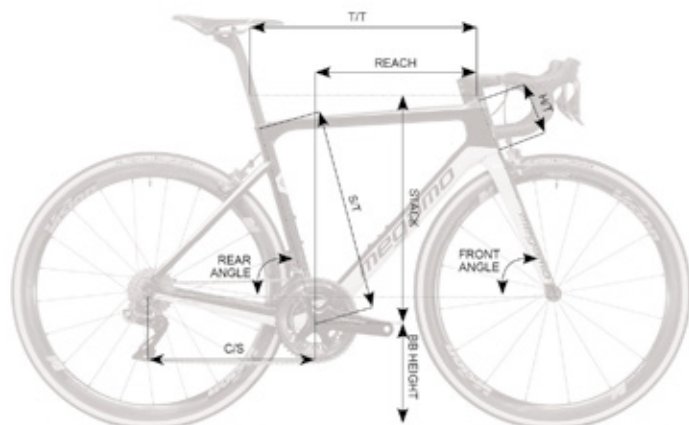

PULSE ELITE 03

	XS	S	M	L	XL
SIZE	-	-	-	-	-
T/T	510	522	541	562	584
C/S	405	405	405	408	408
S/T	450	480	500	520	540
H/T	105	120	138	155	175
REACH	371	374	387	398	409
STACK	500	515	536	554	573
BB HEIGHT	285	285	285	285	285
FRONT ANGLE	71,5	71,5	72,5	73	73
REAR ANGLE	74,5	74	74	73,5	73,5

PULSE ELITE 03 GREY

E-BIKES

MTB

ROAD

FAT

TREKKING











CITY

KIDS BMX

WEAR/ROPA



SPECIFICATIONS / ESPECIFICACIONES

-  CARBON ADVANCED COMPOSITE FRAME, FULL INTERNAL CABLE ROUTING, DIRECT MOUNT BRAKE
-  CARBON FORK
-  INTEGRATED INTERNAL ROUTING
-  CARBON FULL INTEGRATED INTERNAL ROUTING
-  AERODYNAMIC ADVANCED CARBON SEATPOST
-  SELLE ITALIA SLR TITANIUM RAIL
-  SHIMANO ULTEGRA Di2 8050 11s
-  SHIMANO ULTEGRA Di2 8050 11s
-  SHIMANO ULTEGRA 8000 11s 52-36T
-  SHIMANO ULTEGRA Di2 8050 11s

-  SHIMANO ULTEGRA Di2 8000 11s
-  VISION METRON 40
-  VISION METRON 40
-  VITTORIA CORSA 700x25C BROWN SIDE
-  SHIMANO DURA-ACE 9100 11s 11-30T

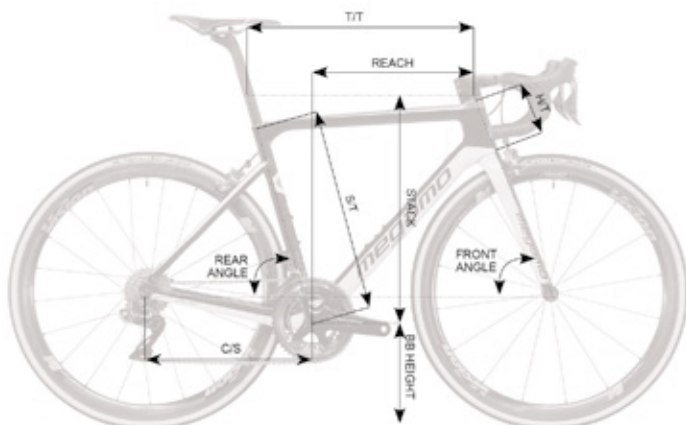











PULSE ELITE 03

	XS	S	M	L	XL
SIZE	-	-	-	-	-
T/T	510	522	541	562	584
C/S	405	405	405	408	408
S/T	450	480	500	520	540
H/T	105	120	138	155	175
REACH	371	374	387	398	409
STACK	500	515	536	554	573
BB HEIGHT	285	285	285	285	285
FRONT ANGLE	71,5	71,5	72,5	73	73
REAR ANGLE	74,5	74	74	73,5	73,5

PULSE ELITE 05 YELLOW



SPECIFICATIONS / ESPECIFICACIONES

-  CARBON ADVANCED COMPOSITE FRAME, FULL INTERNAL CABLE ROUTING, DIRECT MOUNT BRAKE
-  CARBON ADVANCED FORK, DIRECT MOUNT BRAKE
-  INTEGRATED INTERNAL ROUTING
-  CARBON FULL INTEGRATED INTERNAL ROUTING
-  AERODINAMIC ADVANCED CARBON SEATPOST
-  SELLE ITALIA SLR
-  SHIMANO ULTEGRA Di2 8050 11s
-  SHIMANO ULTEGRA Di2 8050 11s
-  SHIMANO ULTEGRA 8000 11s 52-36T
-  SHIMANO ULTEGRA Di2 8050 11s

-  SHIMANO ULTEGRA Di2 8000 11s
-  VISION TEAM 30 COMP
-  VISION TEAM 30 COMP
-  VITTORIA RUBINO 700x25C
-  SHIMANO ULTEGRA 8000 11s 11-30T

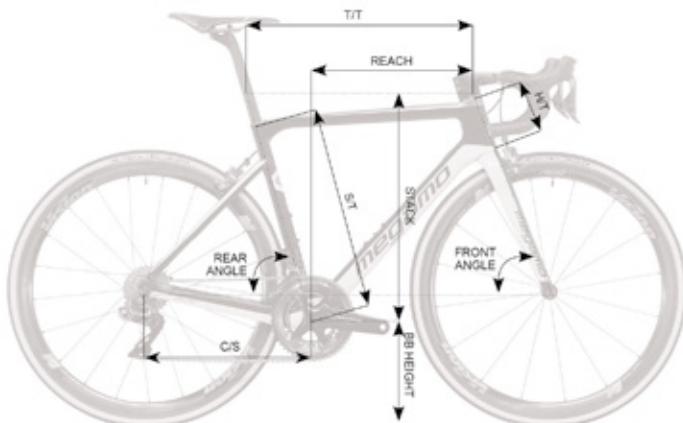

PULSE ELITE 05

	XS	S	M	L	XL
SIZE	-	-	-	-	-
T/T	510	522	541	562	584
C/S	405	405	405	408	408
S/T	450	480	500	520	540
H/T	105	120	138	155	175
REACH	371	374	387	398	409
STACK	500	515	536	554	573
BB HEIGHT	285	285	285	285	285
FRONT ANGLE	71,5	71,5	72,5	73	73
REAR ANGLE	74,5	74	74	73,5	73,5

PULSE ELITE 05 GREEN

E-BIKES

MTB

ROAD

FAT

TREKKING

CITY

KIDS BMX

WEAR/ROPA



SPECIFICATIONS / ESPECIFICACIONES

 CARBON ADVANCED COMPOSITE FRAME, FULL INTERNAL CABLE ROUTING, DIRECT MOUNT BRAKE

 CARBON ADVANCED FORK, DIRECT MOUNT BRAKE

 INTEGRATED INTERNAL ROUTING

 CARBON FULL INTEGRATED INTERNAL ROUTING

 AERODINAMIC ADVANCED CARBON SEATPOST

 SELLE ITALIA SLR

 SHIMANO ULTEGRA Di2 8050 11s

 SHIMANO ULTEGRA Di2 8050 11s

 SHIMANO ULTEGRA 8000 11s 52-36T

 SHIMANO ULTEGRA Di2 8050 11s

 SHIMANO ULTEGRA Di2 8000 11s

 VISION TEAM 30 COMP

 VISION TEAM 30 COMP

 VITTORIA RUBINO 700x25C

 SHIMANO ULTEGRA 8000 11s 11-30T

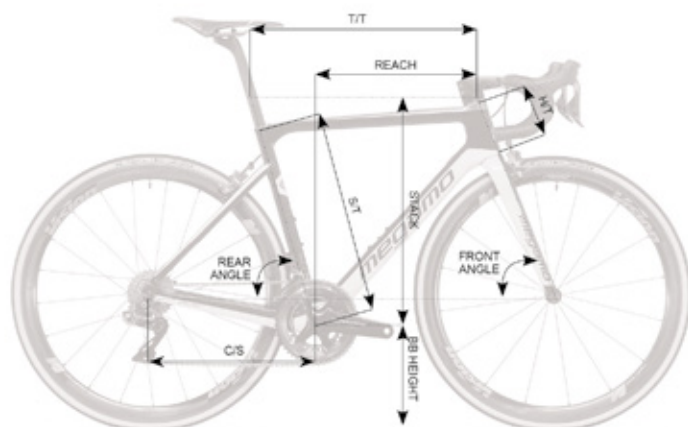

PULSE ELITE 05

	XS	S	M	L	XL
SIZE	-	-	-	-	-
T/T	510	522	541	562	584
C/S	405	405	405	408	408
S/T	450	480	500	520	540
H/T	105	120	138	155	175
REACH	371	374	387	398	409
STACK	500	515	536	554	573
BB HEIGHT	285	285	285	285	285
FRONT ANGLE	71,5	71,5	72,5	73	73
REAR ANGLE	74,5	74	74	73,5	73,5

PULSE ELITE 05 GREY



SPECIFICATIONS / ESPECIFICACIONES

 CARBON ADVANCED COMPOSITE FRAME, FULL INTERNAL CABLE ROUTING, DIRECT MOUNT BRAKE

 CARBON ADVANCED FORK, DIRECT MOUNT BRAKE

 INTEGRATED INTERNAL ROUTING

 CARBON FULL INTEGRATED INTERNAL ROUTING

 AERODINAMIC ADVANCED CARBON SEATPOST

 SELLE ITALIA SLR

 SHIMANO ULTEGRA Di2 8050 11s

 SHIMANO ULTEGRA Di2 8050 11s

 SHIMANO ULTEGRA 8000 11s 52-36T

 SHIMANO ULTEGRA Di2 8050 11s

 SHIMANO ULTEGRA Di2 8000 11s

 VISION TEAM 30 COMP

 VISION TEAM 30 COMP

 VITTORIA RUBINO 700x25C

 SHIMANO ULTEGRA 8000 11s 11-30T

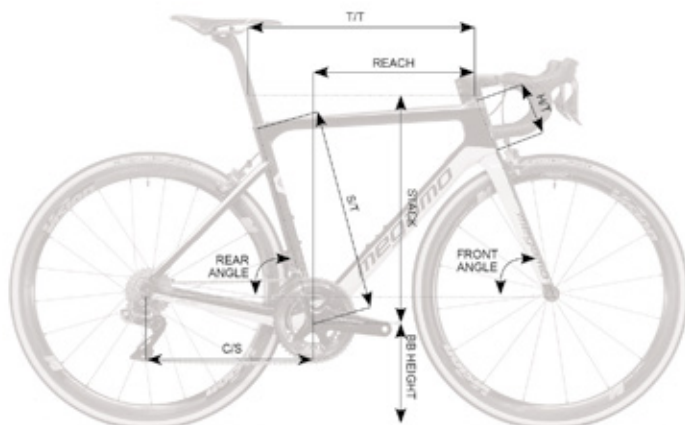











PULSE ELITE 05

	XS	S	M	L	XL
SIZE	-	-	-	-	-
T/T	510	522	541	562	584
C/S	405	405	405	408	408
S/T	450	480	500	520	540
H/T	105	120	138	155	175
REACH	371	374	387	398	409
STACK	500	515	536	554	573
BB HEIGHT	285	285	285	285	285
FRONT ANGLE	71,5	71,5	72,5	73	73
REAR ANGLE	74,5	74	74	73,5	73,5

PULSE ELITE 10 YELLOW



SPECIFICATIONS / ESPECIFICACIONES

-  CARBON ADVANCED COMPOSITE FRAME, FULL INTERNAL CABLE ROUTING, DIRECT MOUNT BRAKE
-  CARBON ADVANCED FORK, DIRECT MOUNT BRAKE
-  INTEGRATED INTERNAL ROUTING
-  CARBON FULL INTEGRATED INTERNAL ROUTING
-  AERODYNAMIC ADVANCED CARBON SEATPOST
-  SELLE ITALIA X3
-  SHIMANO ULTEGRA 8000 11s
-  SHIMANO ULTEGRA 8000 11s
-  SHIMANO ULTEGRA 8000 11s 52-36T
-  SHIMANO ULTEGRA 8020 11s

-  SHIMANO ULTEGRA 8020 11s
-  VISION TEAM 30 COMP
-  VISION TEAM 30 COMP
-  VITTORIA RUBINO 700x25C
-  SHIMANO ULTEGRA 8000 11s 11-30T

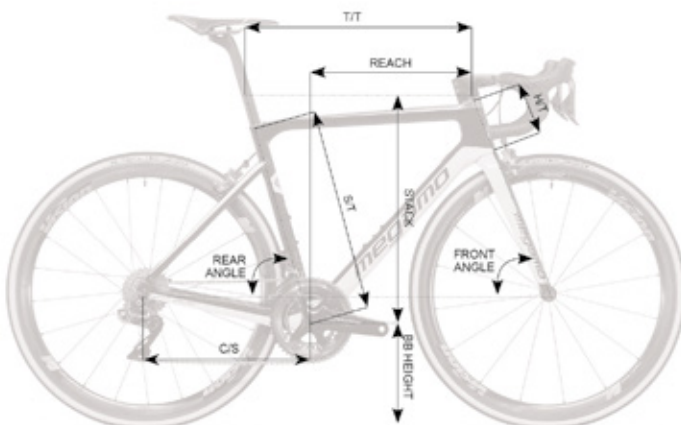

PULSE ELITE 10

	XS	S	M	L	XL
SIZE	-	-	-	-	-
T/T	510	522	541	562	584
C/S	405	405	405	408	408
S/T	450	480	500	520	540
H/T	105	120	138	155	175
REACH	371	374	387	398	409
STACK	500	515	536	554	573
BB HEIGHT	285	285	285	285	285
FRONT ANGLE	71,5	71,5	72,5	73	73
REAR ANGLE	74,5	74	74	73,5	73,5

PULSE ELITE 10 GREEN



SPECIFICATIONS / ESPECIFICACIONES

 CARBON ADVANCED COMPOSITE FRAME, FULL INTERNAL CABLE ROUTING, DIRECT MOUNT BRAKE

 CARBON ADVANCED FORK, DIRECT MOUNT BRAKE

 INTEGRATED INTERNAL ROUTING

 CARBON FULL INTEGRATED INTERNAL ROUTING

 AERODYNAMIC ADVANCED CARBON SEATPOST

 SELLE ITALIA X3

 SHIMANO ULTEGRA 8000 11s

 SHIMANO ULTEGRA 8000 11s

 SHIMANO ULTEGRA 8000 11s 52-36T

 SHIMANO ULTEGRA 8020 11s

 SHIMANO ULTEGRA 8020 11s

 VISION TEAM 30 COMP

 VISION TEAM 30 COMP

 VITTORIA RUBINO 700x25C

 SHIMANO ULTEGRA 8000 11s 11-30T

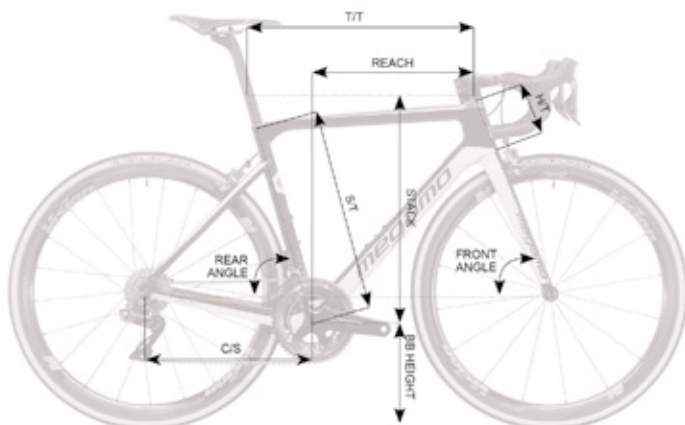

PULSE ELITE 10

	XS	S	M	L	XL
SIZE	-	-	-	-	-
T/T	510	522	541	562	584
C/S	405	405	405	408	408
S/T	450	480	500	520	540
H/T	105	120	138	155	175
REACH	371	374	387	398	409
STACK	500	515	536	554	573
BB HEIGHT	285	285	285	285	285
FRONT ANGLE	71,5	71,5	72,5	73	73
REAR ANGLE	74,5	74	74	73,5	73,5

PULSE ELITE 10 GREY

E-BIKES

MTB

ROAD

FAT

TREKKING











CITY

KIDS BMX

WEAR/ROPA



SPECIFICATIONS / ESPECIFICACIONES

-  CARBON ADVANCED COMPOSITE FRAME, FULL INTERNAL CABLE ROUTING, DIRECT MOUNT BRAKE
-  CARBON ADVANCED FORK, DIRECT MOUNT BRAKE
-  INTEGRATED INTERNAL ROUTING
-  CARBON FULL INTEGRATED INTERNAL ROUTING
-  AERODINAMIC ADVANCED CARBON SEATPOST
-  SELLE ITALIA X3
-  SHIMANO ULTEGRA 8000 11s
-  SHIMANO ULTEGRA 8000 11s
-  SHIMANO ULTEGRA 8000 11s 52-36T
-  SHIMANO ULTEGRA 8020 11s

-  SHIMANO ULTEGRA 8020 11s
-  VISION TEAM 30 COMP
-  VISION TEAM 30 COMP
-  VITTORIA RUBINO 700x25C
-  SHIMANO ULTEGRA 8000 11s 11-30T

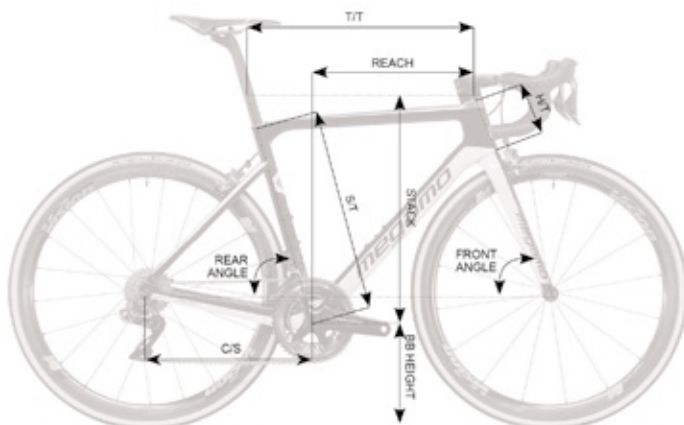

PULSE ELITE 10

	XS	S	M	L	XL
SIZE	-	-	-	-	-
T/T	510	522	541	562	584
C/S	405	405	405	408	408
S/T	450	480	500	520	540
H/T	105	120	138	155	175
REACH	371	374	387	398	409
STACK	500	515	536	554	573
BB HEIGHT	285	285	285	285	285
FRONT ANGLE	71,5	71,5	72,5	73	73
REAR ANGLE	74,5	74	74	73,5	73,5

PULSE ELITE 20 YELLOW



SPECIFICATIONS / ESPECIFICACIONES

 CARBON ADVANCED COMPOSITE FRAME, FULL INTERNAL CABLE ROUTING, DIRECT MOUNT BRAKE

 CARBON ADVANCED FORK, DIRECT MOUNT BRAKE

 INTEGRATED INTERNAL ROUTING

 CARBON FULL INTEGRATED INTERNAL ROUTING

 AERODINAMIC ADVANCED CARBON SEATPOST

 SELLE ITALIA X3

 SHIMANO 105 7000 11s

 SHIMANO 105 7000 11s

 SHIMANO 105 7000 11s 50/34T

 SHIMANO 105 7020 11s

 SHIMANO 105 7020 11s

 VISION TEAM 30 COMP

 VISION TEAM 30 COMP

 VITTORIA RUBINO 700x25C

 SHIMANO 105 7000 11-30T 11s

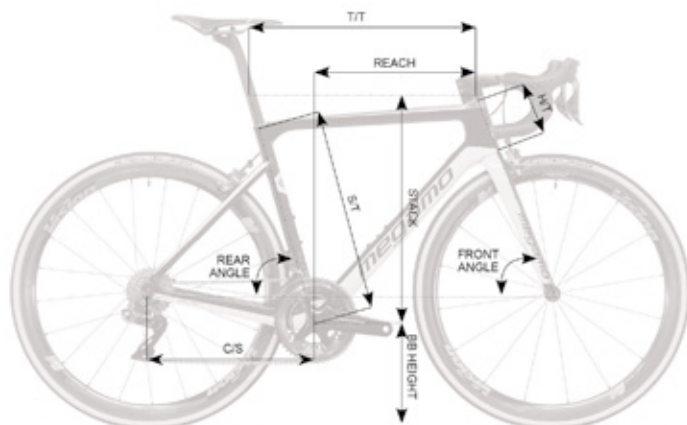

PULSE ELITE 20

	XS	S	M	L	XL
SIZE	-	-	-	-	-
T/T	510	522	541	562	584
C/S	405	405	405	408	408
S/T	450	480	500	520	540
H/T	105	120	138	155	175
REACH	371	374	387	398	409
STACK	500	515	536	554	573
BB HEIGHT	285	285	285	285	285
FRONT ANGLE	71,5	71,5	72,5	73	73
REAR ANGLE	74,5	74	74	73,5	73,5

PULSE ELITE 20 GREEN

E-BIKES

MTB

ROAD

FAT

TREKKING











CITY

KIDS BMX

WEAR/ROPA



SPECIFICATIONS / ESPECIFICACIONES

-  CARBON ADVANCED COMPOSITE FRAME, FULL INTERNAL CABLE ROUTING, DIRECT MOUNT BRAKE
-  CARBON ADVANCED FORK, DIRECT MOUNT BRAKE
-  INTEGRATED INTERNAL ROUTING
-  CARBON FULL INTEGRATED INTERNAL ROUTING
-  AERODINAMIC ADVANCED CARBON SEATPOST
-  SELLE ITALIA X3
-  SHIMANO 105 7000 11s
-  SHIMANO 105 7000 11s
-  SHIMANO 105 7000 11s 50/34T
-  SHIMANO 105 7020 11s

-  SHIMANO 105 7020 11s
-  VISION TEAM 30 COMP
-  VISION TEAM 30 COMP
-  VITTORIA RUBINO 700x25C
-  SHIMANO 105 7000 11-30T 11s

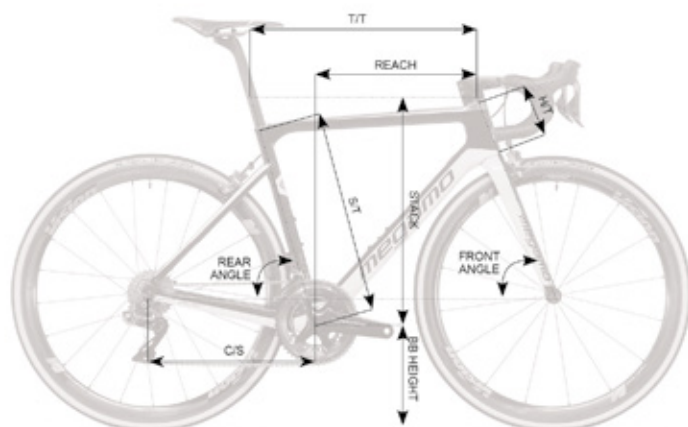

PULSE ELITE 20

	XS	S	M	L	XL
SIZE	-	-	-	-	-
T/T	510	522	541	562	584
C/S	405	405	405	408	408
S/T	450	480	500	520	540
H/T	105	120	138	155	175
REACH	371	374	387	398	409
STACK	500	515	536	554	573
BB HEIGHT	285	285	285	285	285
FRONT ANGLE	71,5	71,5	72,5	73	73
REAR ANGLE	74,5	74	74	73,5	73,5

PULSE ELITE 20 GREY



SPECIFICATIONS / ESPECIFICACIONES

 CARBON ADVANCED COMPOSITE FRAME, FULL INTERNAL CABLE ROUTING, DIRECT MOUNT BRAKE

 CARBON ADVANCED FORK, DIRECT MOUNT BRAKE

 INTEGRATED INTERNAL ROUTING

 CARBON FULL INTEGRATED INTERNAL ROUTING

 AERODINAMIC ADVANCED CARBON SEATPOST

 SELLE ITALIA X3

 SHIMANO 105 7000 11s

 SHIMANO 105 7000 11s

 SHIMANO 105 7000 11s 50/34T

 SHIMANO 105 7020 11s

 SHIMANO 105 7020 11s

 VISION TEAM 30 COMP

 VISION TEAM 30 COMP

 VITTORIA RUBINO 700x25C

 SHIMANO 105 7000 11-30T 11s

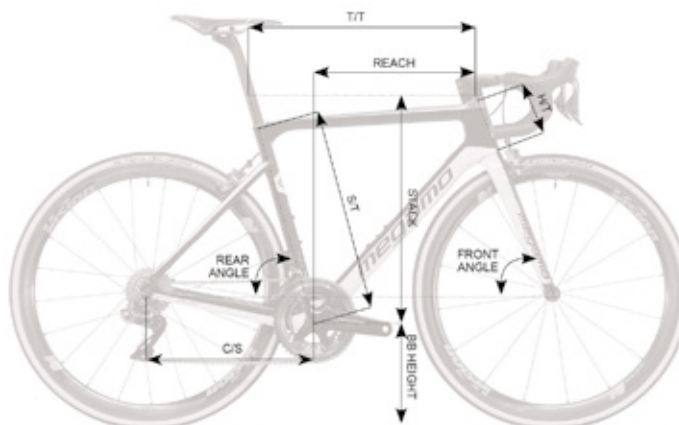

PULSE ELITE 20

	XS	S	M	L	XL
SIZE	-	-	-	-	-
T/T	510	522	541	562	584
C/S	405	405	405	408	408
S/T	450	480	500	520	540
H/T	105	120	138	155	175
REACH	371	374	387	398	409
STACK	500	515	536	554	573
BB HEIGHT	285	285	285	285	285
FRONT ANGLE	71,5	71,5	72,5	73	73
REAR ANGLE	74,5	74	74	73,5	73,5



WEAR/ROPA

KIDS BMX

CITY

TREKKING

FAT

ROAD

MTB

E-BIKES

RAISE



Enjoy the pure cycling, without limits of time or space. This is the maximum with which the Raise model has been developed. A complete bicycle, to enjoy even irregular stretches or gravel. With the safety of the new Flat mount disc braking system and the stiffness of the front and rear through axles. They are advantages in comfort and comfort that determine the final result in long routes.

Disfruta del puro ciclismo, sin límites de tiempo ni espacio. Esta es la máxima con que se ha desarrollado el modelo Raise. Una bicicleta completa, para poder disfrutar incluso de tramos irregulares o con gravilla. Con la seguridad del nuevo sistema de frenado de disco Flat mount y la rigidez de los ejes pasantes delantero y trasero. Son ventajas en comodidad y confort que determinan el resultado final en rutas largas.



THE CONCEPT OF INTEGRATION

Fork with specific design and internal cable routing. With integrated brakes also.

EL CONCEPTO DE LA INTEGRACIÓN

Horquilla con diseño específico y cableado interno. El anclaje es integrado.

REAR STAYS AND THRU AXLES

Thru axles 12mm, for more rigidity. Also with rear stays empty for a more natural cable routing

PUNTERAS Y EJES PASANTES

Ejes pasantes de 12mm, para una rigidez mayor. Anclaje de la pinza integrado.

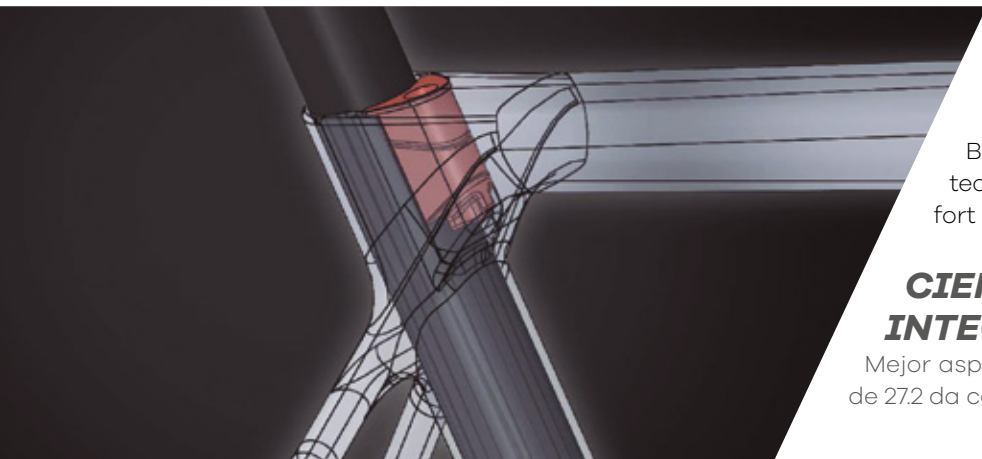

SEAT CLAMP INTEGRATED

Better visual appearance with the integrated closure. The 27.2mm seat provides comfort and absorption.

CIERRE DE SILLÍN INTEGRADO

Mejor aspecto visual con el cierre integrado. La tija de 27.2 da comodidad y absorción.

BBSET BB86

This Standard size optimize material used on this part to provide more rigidity.

CAJA PEDALIER BB86

















Este tamaño estándar optimiza el material utilizado en esta pieza para proporcionar más rigidez.



RAISE 03 YELLOW



SPECIFICATIONS / ESPECIFICACIONES

 MONOCOQUE CARBON FRAME , THRU AXLES 12x142, FLAT MOUNT BRAKES, INTERNAL CABLE ROUTING, DI2 SPECIFIC DESIGN	 SHIMANO ULTEGRA Di2 R8070 11s HYDRAULIC DISC
 ADVANCED CARBON FORK, FLAT MOUNT BRAKES, THRU AXLE 12X100	 VISION METRON 40 DISC 12x100 / 12x142
 FSA 1-1/8 1-1/2 * 1.5 TAPERED	 VISION METRON 40 DISC
 FSA SL-K CARBON	 VITTORIA CORSA 700CX25C BROWN SIDE
 FSA SL-K STEM	 SHIMANO ULTEGRA R8000 11s 11-30T
 FSA SL-K CARBON 27,2	
 SELLE ITALIA SLR TITANIUM	
 SHIMANO ULTEGRA Di2 R8050 11s	
 SHIMANO ULTEGRA Di2 R8050 11s	
 SHIMANO ULTEGRA R8000 11s 52-36	
 SHIMANO ULTEGRA Di2 R8070 11s	

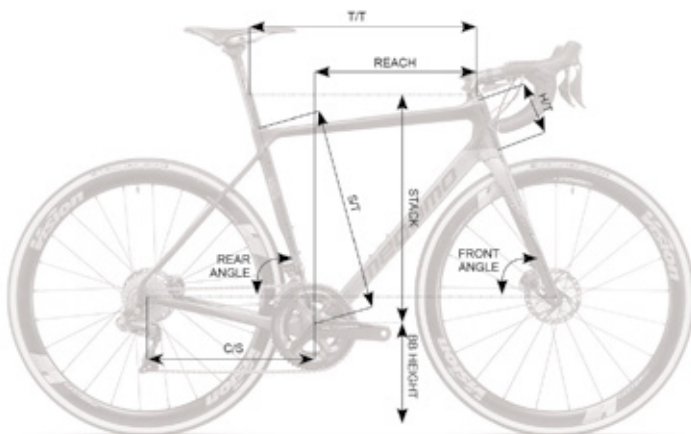

RAISE 03

	XS	S	M	L	XL
SIZE	470	500	530	560	590
T/T	522	537	552	570	588
C/S	415	415	415	415	415
S/T	458	458	498	523	523
H/T	115	130	150	170	190
REACH	375	385	393	400	412
STACK	513	530	553	574	593
BB HEIGHT	274	274	274	274	274
FRONT ANGLE	71°	72°	73°	73,5°	73,5°
REAR ANGLE	74°	74°	74°	73,5°	73,5°

RAISE 03 GREEN

E-BIKES

MTB

ROAD

FAT

TREKKING











CITY

KIDS BMX

WEAR/ROPA



SPECIFICATIONS / ESPECIFICACIONES

-  MONOCOQUE CARBON FRAME , THRU AXLES 12x142, FLAT MOUNT BRAKES, INTERNAL CABLE ROUTING, DI2 SPECIFIC DESIGN
-  ADVANCED CARBON FORK, FLAT MOUNT BRAKES, THRU AXLE 12X100
-  FSA 1-1/8 1-1/2 * 1.5 TAPERED
-  FSA SL-K CARBON
-  FSA SL-K STEM
-  FSA SL-K CARBON 27,2
-  SELLE ITALIA SLR TITANIUM
-  SHIMANO ULTEGRA DI2 R8050 11s
-  SHIMANO ULTEGRA DI2 R8050 11s
-  SHIMANO ULTEGRA R8000 11s 52-36
-  SHIMANO ULTEGRA DI2 R8070 11s

-  SHIMANO ULTEGRA DI2 R8070 11s HYDRAULIC DISC
-  VISION METRON 40 DISC 12x100 / 12x142
-  VISION METRON 40 DISC
-  VITTORIA CORSA 700CX25C BROWN SIDE
-  SHIMANO ULTEGRA R8000 11s 11-30T

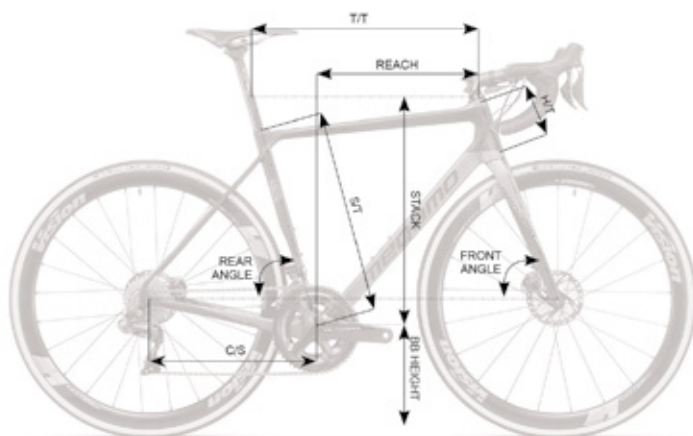











RAISE 03

	XS	S	M	L	XL
SIZE	470	500	530	560	590
T/T	522	537	552	570	588
C/S	415	415	415	415	415
S/T	458	458	498	523	523
H/T	115	130	150	170	190
REACH	375	385	393	400	412
STACK	513	530	553	574	593
BB HEIGHT	274	274	274	274	274
FRONT ANGLE	71°	72°	73°	73,5°	73,5°
REAR ANGLE	74°	74°	74°	73,5°	73,5°

RAISE 03 GREY



SPECIFICATIONS / ESPECIFICACIONES

-  MONOCOQUE CARBON FRAME , THRU AXLES 12x142, FLAT MOUNT BRAKES, INTERNAL CABLE ROUTING, DI2 SPECIFIC DESIGN
-  ADVANCED CARBON FORK, FLAT MOUNT BRAKES, THRU AXLE 12X100
-  FSA 1-1/8 1-1/2 * 1.5 TAPERED
-  FSA SL-K CARBON
-  FSA SL-K STEM
-  FSA SL-K CARBON 27,2
-  SELLE ITALIA SLR TITANIUM
-  SHIMANO ULTEGRA Di2 R8050 11s
-  SHIMANO ULTEGRA Di2 R8050 11s
-  SHIMANO ULTEGRA R8000 11s 52-36
-  SHIMANO ULTEGRA Di2 R8070 11s

-  SHIMANO ULTEGRA Di2 R8070 11s HYDRAULIC DISC
-  VISION METRON 40 DISC 12x100 / 12x142
-  VISION METRON 40 DISC
-  VITTORIA CORSA 700CX25C BROWN SIDE
-  SHIMANO ULTEGRA R8000 11s 11-30T

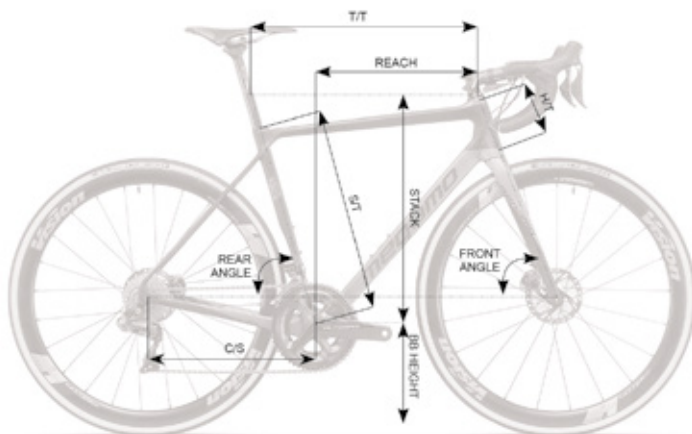

RAISE 03

	XS	S	M	L	XL
SIZE	470	500	530	560	590
T/T	522	537	552	570	588
C/S	415	415	415	415	415
S/T	458	458	498	523	523
H/T	115	130	150	170	190
REACH	375	385	393	400	412
STACK	513	530	553	574	593
BB HEIGHT	274	274	274	274	274
FRONT ANGLE	71°	72°	73°	73,5°	73,5°
REAR ANGLE	74°	74°	74°	73,5°	73,5°

RAISE 05 YELLOW

E-BIKES

MTB

ROAD

FAT

TREKKING











CITY

KIDS BMX

WEAR/ROPA



SPECIFICATIONS / ESPECIFICACIONES

-  MONOCOQUE CARBON FRAME , THRU AXLES 12x142, FLAT MOUNT BRAKES, INTERNAL CABLE ROUTING, Di2 SPECIFIC DESIGN
-  ADVANCED CARBON FORK, FLAT MOUNT BRAKES, THRU AXLE 12X100
-  FSA 1-1/8 1-1/2 * 1.5 TAPERED
-  FSA VERO COMPACT ROAD
-  FSA OS-168
-  FSA GOSSAMER 27,2mm
-  SELLE ITALIA X3
-  SHIMANO ULTEGRA Di2 R8050 11s
-  SHIMANO ULTEGRA Di2 R8050 11s
-  SHIMANO ULTEGRA R8000 11s 52-36
-  SHIMANO ULTEGRA Di2 R8070 11s

-  SHIMANO ULTEGRA Di2 R8070 11s HYDRAULIC DISC
-  VISION TEAM 30 DISC 12x100 / 12x142
-  VISION TEAM 30 DISC COMP
-  VITTORIA RUBINO 700x25C
-  SHIMANO ULTEGRA R8000 11s 11-30T

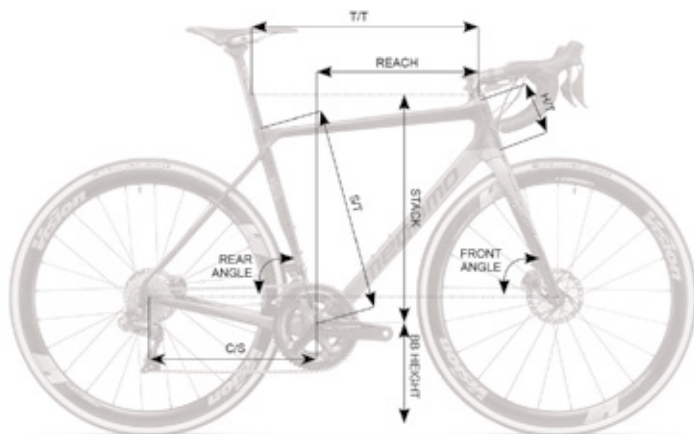











RAISE 05

	XS	S	M	L	XL
SIZE	470	500	530	560	590
T/T	522	537	552	570	588
C/S	415	415	415	415	415
S/T	458	458	498	523	523
H/T	115	130	150	170	190
REACH	375	385	393	400	412
STACK	513	530	553	574	593
BB HEIGHT	274	274	274	274	274
FRONT ANGLE	71°	72°	73°	73,5°	73,5°
REAR ANGLE	74°	74°	74°	73,5°	73,5°

RAISE 05 GREEN



SPECIFICATIONS / ESPECIFICACIONES

-  MONOCOQUE CARBON FRAME , THRU AXLES 12x142, FLAT MOUNT BRAKES, INTERNAL CABLE ROUTING, DI2 SPECIFIC DESIGN
-  ADVANCED CARBON FORK, FLAT MOUNT BRAKES, THRU AXLE 12X100
-  FSA 1-1/8 1-1/2 * 1.5 TAPERED
-  FSA VERO COMPACT ROAD
-  FSA OS-168
-  FSA GOSSAMER 27,2mm
-  SELLE ITALIA X3
-  SHIMANO ULTEGRA Di2 R8050 11s
-  SHIMANO ULTEGRA Di2 R8050 11s
-  SHIMANO ULTEGRA R8000 11s 52-36
-  SHIMANO ULTEGRA Di2 R8070 11s

-  SHIMANO ULTEGRA Di2 R8070 11s HYDRAULIC DISC
-  VISION TEAM 30 DISC 12x100 / 12x142
-  VISION TEAM 30 DISC COMP
-  VITTORIA RUBINO 700x25C
-  SHIMANO ULTEGRA R8000 11s 11-30T

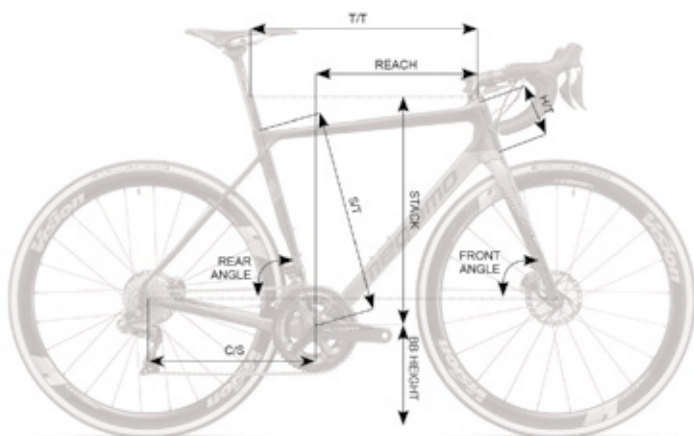

RAISE 05

	XS	S	M	L	XL
SIZE	470	500	530	560	590
T/T	522	537	552	570	588
C/S	415	415	415	415	415
S/T	458	458	498	523	523
H/T	115	130	150	170	190
REACH	375	385	393	400	412
STACK	513	530	553	574	593
BB HEIGHT	274	274	274	274	274
FRONT ANGLE	71°	72°	73°	73,5°	73,5°
REAR ANGLE	74°	74°	74°	73,5°	73,5°

RAISE 05 GREY

E-BIKES

MTB

ROAD

FAT

TREKKING

















CITY

KIDS BMX

WEAR/ROPA



SPECIFICATIONS / ESPECIFICACIONES

-  MONOCOQUE CARBON FRAME , THRU AXLES 12x142, FLAT MOUNT BRAKES, INTERNAL CABLE ROUTING, Di2 SPECIFIC DESIGN
-  ADVANCED CARBON FORK, FLAT MOUNT BRAKES, THRU AXLE 12X100
-  FSA 1-1/8 1-1/2 * 1.5 TAPERED
-  FSA VERO COMPACT ROAD
-  FSA OS-168
-  FSA GOSSAMER 27,2mm
-  SELLE ITALIA X3
-  SHIMANO ULTEGRA Di2 R8050 11s
-  SHIMANO ULTEGRA Di2 R8050 11s
-  SHIMANO ULTEGRA R8000 11s 52-36
-  SHIMANO ULTEGRA Di2 R8070 11s
-  SHIMANO ULTEGRA Di2 R8070 11s HYDRAULIC DISC
-  VISION TEAM 30 DISC 12x100 / 12x142
-  VISION TEAM 30 DISC COMP
-  VITTORIA RUBINO 700x25C
-  SHIMANO ULTEGRA R8000 11s 11-30T

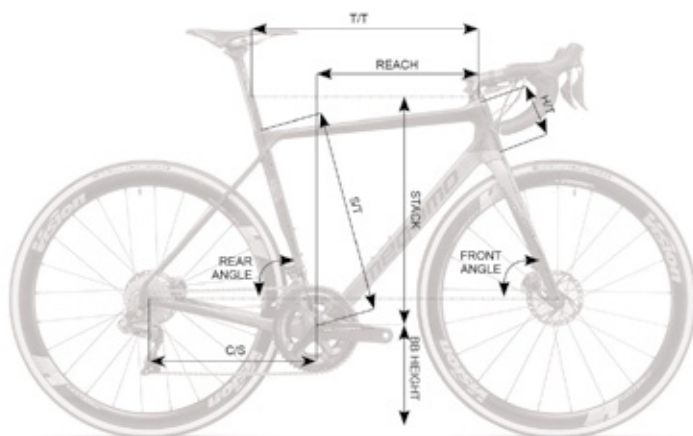

















RAISE 05

	XS	S	M	L	XL
SIZE	470	500	530	560	590
T/T	522	537	552	570	588
C/S	415	415	415	415	415
S/T	458	458	498	523	523
H/T	115	130	150	170	190
REACH	375	385	393	400	412
STACK	513	530	553	574	593
BB HEIGHT	274	274	274	274	274
FRONT ANGLE	71°	72°	73°	73,5°	73,5°
REAR ANGLE	74°	74°	74°	73,5°	73,5°

RAISE 10 YELLOW



SPECIFICATIONS / ESPECIFICACIONES

-  MONOCOQUE CARBON FRAME, THRU AXLES 12x142, FLAT MOUNT BRAKES, INTERNAL CABLE ROUTING, Di2 SPECIFIC DESIGN
-  ADVANCED CARBON FORK, FLAT MOUNT BRAKES, THRU AXLE 12X100
-  FSA 1-1/8 1-1/2 * 1.5 TAPERED
-  FSA VERO COMPACT ROAD
-  FSA OS-168
-  FSA GOSSAMER 27,2mm
-  SELLE ITALIA X3
-  SHIMANO ULTEGRA R8000 11s
-  SHIMANO ULTEGRA R8000 11s
-  SHIMANO ULTEGRA R8000 11s 52-36
-  SHIMANO ULTEGRA R8020 11s
-  SHIMANO ULTEGRA R8020 11s HIDRAULIC DISC
-  VISION TEAM 30 DISC
-  VISION TEAM 30 DISC
-  VITTORIA RUBINO 700CX25C
-  SHIMANO 105 7000 11s 11-30T

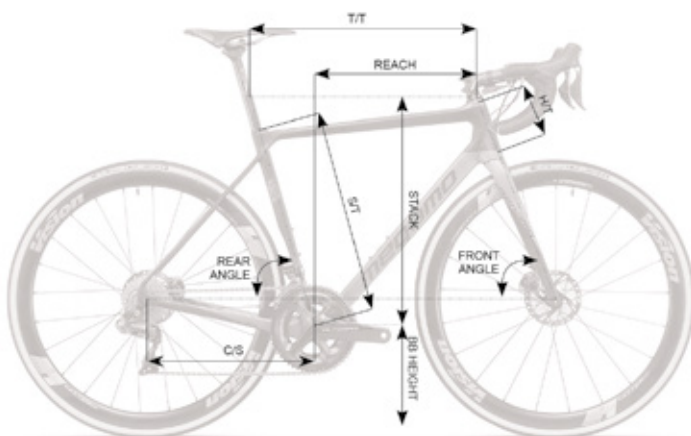











RAISE 10

	XS	S	M	L	XL
SIZE	470	500	530	560	590
T/T	522	537	552	570	588
C/S	415	415	415	415	415
S/T	458	458	498	523	523
H/T	115	130	150	170	190
REACH	375	385	393	400	412
STACK	513	530	553	574	593
BB HEIGHT	274	274	274	274	274
FRONT ANGLE	71°	72°	73°	73,5°	73,5°
REAR ANGLE	74°	74°	74°	73,5°	73,5°



SPECIFICATIONS / ESPECIFICACIONES

-  MONOCOQUE CARBON FRAME , THRU AXLES 12x142, FLAT MOUNT BRAKES, INTERNAL CABLE ROUTING, DI2 SPECIFIC DESIGN
-  ADVANCED CARBON FORK, FLAT MOUNT BRAKES, THRU AXLE 12X100
-  FSA 1-1/8 1-1/2 * 1.5 TAPERED
-  FSA VERO COMPACT ROAD
-  FSA OS-168
-  FSA GOSSAMER 27,2mm
-  SELLE ITALIA X3
-  SHIMANO ULTEGRA R8000 11s
-  SHIMANO ULTEGRA R8000 11s
-  SHIMANO ULTEGRA R8000 11s 52-36
-  SHIMANO ULTEGRA R8020 11s

-  SHIMANO ULTEGRA R8020 11s HIDRAULIC DISC
-  VISION TEAM 30 DISC
-  VISION TEAM 30 DISC
-  VITTORIA RUBINO 700CX25C
-  SHIMANO 105 7000 11s 11-30T

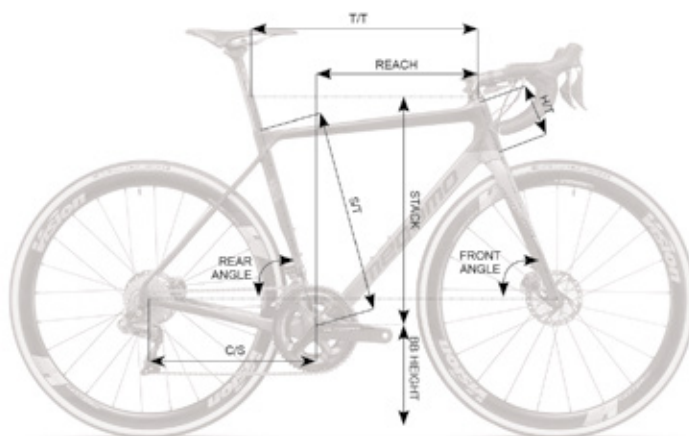











RAISE 10

	XS	S	M	L	XL
SIZE	470	500	530	560	590
T/T	522	537	552	570	588
C/S	415	415	415	415	415
S/T	458	458	498	523	523
H/T	115	130	150	170	190
REACH	375	385	393	400	412
STACK	513	530	553	574	593
BB HEIGHT	274	274	274	274	274
FRONT ANGLE	71°	72°	73°	73,5°	73,5°
REAR ANGLE	74°	74°	74°	73,5°	73,5°

RAISE 10 GREY



SPECIFICATIONS / ESPECIFICACIONES

-  MONOCOQUE CARBON FRAME , THRU AXLES 12x142, FLAT MOUNT BRAKES, INTERNAL CABLE ROUTING, DI2 SPECIFIC DESIGN
-  ADVANCED CARBON FORK, FLAT MOUNT BRAKES, THRU AXLE 12X100
-  FSA 1-1/8 1-1/2 * 1.5 TAPERED
-  FSA VERO COMPACT ROAD
-  FSA OS-168
-  FSA GOSSAMER 27,2mm
-  SELLE ITALIA X3
-  SHIMANO ULTEGRA R8000 11s
-  SHIMANO ULTEGRA R8000 11s
-  SHIMANO ULTEGRA R8000 11s 52-36
-  SHIMANO ULTEGRA R8020 11s

-  SHIMANO ULTEGRA R8020 11s HIDRAULIC DISC
-  VISION TEAM 30 DISC
-  VISION TEAM 30 DISC
-  VITTORIA RUBINO 700CX25C
-  SHIMANO 105 7000 11s 11-30T

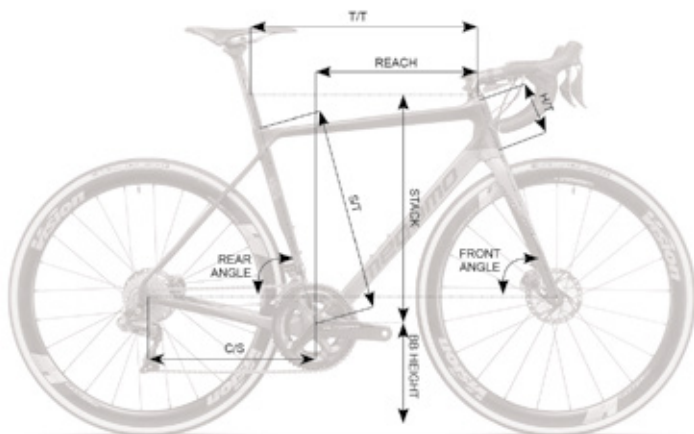

RAISE 10

	XS	S	M	L	XL
SIZE	470	500	530	560	590
T/T	522	537	552	570	588
C/S	415	415	415	415	415
S/T	458	458	498	523	523
H/T	115	130	150	170	190
REACH	375	385	393	400	412
STACK	513	530	553	574	593
BB HEIGHT	274	274	274	274	274
FRONT ANGLE	71°	72°	73°	73,5°	73,5°
REAR ANGLE	74°	74°	74°	73,5°	73,5°

RAISE 20 YELLOW

E-BIKES

MTB

ROAD

FAT

TREKKING











CITY

KIDS BMX

WEAR/ROPA



SPECIFICATIONS / ESPECIFICACIONES

-  MONOCOQUE CARBON FRAME , THRU AXLES 12x142, FLAT MOUNT BRAKES, INTERNAL CABLE ROUTING, Di2 SPECIFIC DESIGN
-  ADVANCED CARBON FORK, FLAT MOUNT BRAKES, THRU AXLE 12X100
-  FSA 1-1/8 1-1/2 * 1.5 TAPERED
-  MEGAMO FOV COMPACT
-  MEGAMO FOV COMPACT
-  MEGAMO 27,2mm
-  SELLE ITALIA X3
-  SHIMANO 105 7000 11s
-  SHIMANO 105 7000 11s
-  SHIMANO 105 7000 11s 50/34T
-  SHIMANO 105 7020 11s

-  SHIMANO 105 7070 11s HYDRAULIC DISC
-  VISION TEAM 30 DISC
-  VISION TEAM 30 DISC
-  VITTORIA RUBINO 700x25C
-  SHIMANO 105 7000 11-30T 11s

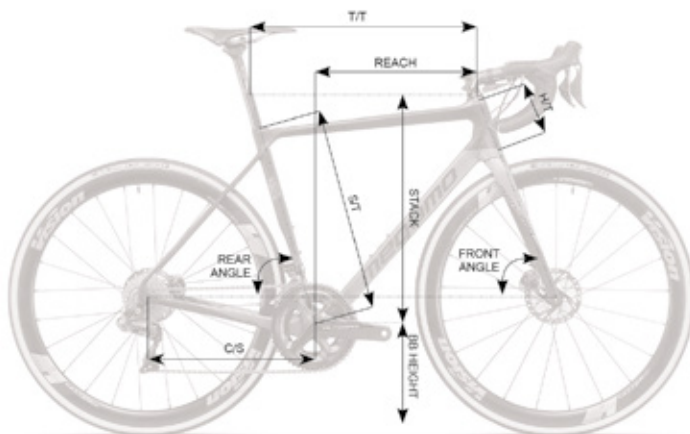

















RAISE 20

	XS	S	M	L	XL
SIZE	470	500	530	560	590
T/T	522	537	552	570	588
C/S	415	415	415	415	415
S/T	458	458	498	523	523
H/T	115	130	150	170	190
REACH	375	385	393	400	412
STACK	513	530	553	574	593
BB HEIGHT	274	274	274	274	274
FRONT ANGLE	71°	72°	73°	73,5°	73,5°
REAR ANGLE	74°	74°	74°	73,5°	73,5°

RAISE 20 GREEN



SPECIFICATIONS / ESPECIFICACIONES

-  MONOCOQUE CARBON FRAME , THRU AXLES 12x142, FLAT MOUNT BRAKES, INTERNAL CABLE ROUTING, DI2 SPECIFIC DESIGN
-  ADVANCED CARBON FORK, FLAT MOUNT BRAKES, THRU AXLE 12X100
-  FSA 1-1/8 1-1/2 * 1.5 TAPERED
-  MEGAMO FOV COMPACT
-  MEGAMO FOV COMPACT
-  MEGAMO 27,2mm
-  SELLE ITALIA X3
-  SHIMANO 105 7000 11s
-  SHIMANO 105 7000 11s
-  SHIMANO 105 7000 11s 50/34T
-  SHIMANO 105 7020 11s
-  SHIMANO 105 7070 11s HYDRAULIC DISC
-  VISION TEAM 30 DISC
-  VISION TEAM 30 DISC
-  VITTORIA RUBINO 700x25C
-  SHIMANO 105 7000 11-30T 11s

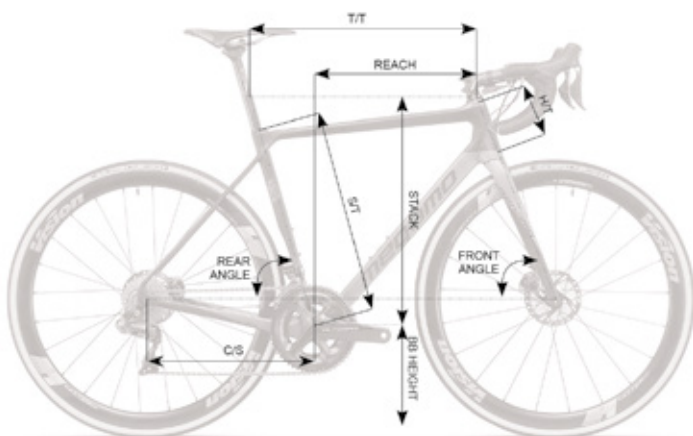

















RAISE 20

	XS	S	M	L	XL
SIZE	470	500	530	560	590
T/T	522	537	552	570	588
C/S	415	415	415	415	415
S/T	458	458	498	523	523
H/T	115	130	150	170	190
REACH	375	385	393	400	412
STACK	513	530	553	574	593
BB HEIGHT	274	274	274	274	274
FRONT ANGLE	71°	72°	73°	73,5°	73,5°
REAR ANGLE	74°	74°	74°	73,5°	73,5°



SPECIFICATIONS / ESPECIFICACIONES

-  MONOCOQUE CARBON FRAME , THRU AXLES 12x142, FLAT MOUNT BRAKES, INTERNAL CABLE ROUTING, DI2 SPECIFIC DESIGN
-  ADVANCED CARBON FORK, FLAT MOUNT BRAKES, THRU AXLE 12X100
-  FSA 1-1/8 1-1/2 * 1.5 TAPERED
-  MEGAMO FOV COMPACT
-  MEGAMO FOV COMPACT
-  MEGAMO 27,2mm
-  SELLE ITALIA X3
-  SHIMANO 105 7000 11s
-  SHIMANO 105 7000 11s
-  SHIMANO 105 7000 11s 50/34T
-  SHIMANO 105 7020 11s

-  SHIMANO 105 7070 11s HYDRAULIC DISC
-  VISION TEAM 30 DISC
-  VISION TEAM 30 DISC
-  VITTORIA RUBINO 700x25C
-  SHIMANO 105 7000 11-30T 11s

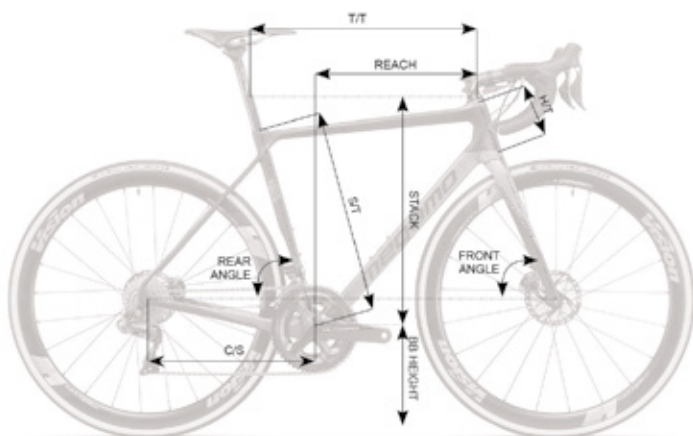

RAISE 20

	XS	S	M	L	XL
SIZE	470	500	530	560	590
T/T	522	537	552	570	588
C/S	415	415	415	415	415
S/T	458	458	498	523	523
H/T	115	130	150	170	190
REACH	375	385	393	400	412
STACK	513	530	553	574	593
BB HEIGHT	274	274	274	274	274
FRONT ANGLE	71°	72°	73°	73,5°	73,5°
REAR ANGLE	74°	74°	74°	73,5°	73,5°

CORE



Subtlety in its purest form! The new Core has been designed to give the best performance. Touring the mountain passes and your favorite roads will be easy task for her. Developed in conjunction with the most thorough pilots and with all the attention a masterpiece needs. She is ready !!

Sutileza en estado puro! La nueva Core ha sido diseñada para dar el mejor rendimiento. Recorrer los puertos de montaña y tus carreteras favoritas será tarea fácil para ella. Desarrollada conjuntamente con los corredores mas minuciosos y con toda la atención que necesita una obra maestra. Ella esta preparada, ahora solo faltas tu.



ROUTING WITH EMPTY REAR STAYS

New empty rear stays that allow more natural routing.

CABLEADO CON PUNTERAS VACÍAS

Nuevas punteras vacías que permiten un cableado más natural.

SPECIFIC PRODUCTION PLAN

Different types of fiber depending on the area and effort you receive.

CONSTRUCCIÓN ESPECÍFICA

Diferentes tipos de fibra en función de la zona y esfuerzo que recibe.



BBSET BB86

This Standard size optimize material used on this part to provide more rigidity.

CAJA PEDALIER BB86

Este tamaño estandar optimiza el material utilizado en esta pieza para proporcionar mas rigidez.

SEAT CLAMP INTEGRATED

Better visual appearance with the integrated closure. The 27.2mm seat provides comfort and absorption.

CIERRE DE SILLÍN INTEGRADO

















Mejor aspecto visual con el cierre integrado. La tija de 27.2mm da comodidad y absorción.



CORE 03 YELLOW



SPECIFICATIONS / ESPECIFICACIONES

-  MONOCOQUE CARBON FRAME, INTERNAL CABLE ROUTING, INTEGRATED SEAT CLAMP, Di2 SPECIFIC DESIGN
-  ADVANCED CARBON FORK DESIGN
-  FSA 1-1/8 1-1/2 * 1.5 TAPERED
-  FSA SL-K CARBON
-  FSA SL-K STEM
-  FSA SL-K CARBON 27,2
-  SELLE ITALIA SLR TITANIUM
-  SHIMANO ULTEGRA Di2 R8050 11s
-  SHIMANO ULTEGRA Di2 R8050 11s
-  SHIMANO ULTEGRA R8000 11s 52-36
-  SHIMANO ULTEGRA Di2 R8050 11s
-  SHIMANO ULTEGRA Di2 R8050 11s
-  VISION METRON 40 CARBON
-  VISION METRON 40 CARBON
-  VITTORIA CORSA 700CX25C BROWN SIDE
-  SHIMANO ULTEGRA R8000 11s 11-30T

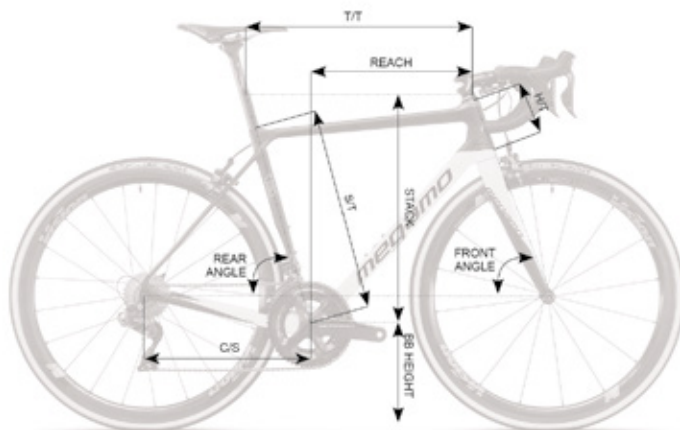















CORE 03

	XS	S	M	L	XL
SIZE	470	500	530	560	590
T/T	522	537	552	570	588
C/S	415	415	415	415	415
S/T	458	458	498	523	523
H/T	115	130	150	170	190
REACH	375	385	393	400	412
STACK	513	530	553	574	593
BB HEIGHT	274	274	274	274	274
FRONT ANGLE	71°	72°	73°	73,5°	73,5°
REAR ANGLE	74°	74°	74°	73,5°	73,5°



SPECIFICATIONS / ESPECIFICACIONES

-  MONOCOQUE CARBON FRAME, INTERNAL CABLE ROUTING, INTEGRATED SEAT CLAMP, DI2 SPECIFIC DESIGN
-  ADVANCED CARBON FORK DESIGN
-  FSA 1-1/8 1-1/2 * 1.5 TAPERED
-  FSA SL-K CARBON
-  FSA SL-K STEM
-  FSA SL-K CARBON 27,2
-  SELLE ITALIA SLR TITANIUM
-  SHIMANO ULTEGRA Di2 R8050 11s
-  SHIMANO ULTEGRA Di2 R8050 11s
-  SHIMANO ULTEGRA R8000 11s 52-36
-  SHIMANO ULTEGRA Di2 R8050 11s
-  SHIMANO ULTEGRA Di2 R8050 11s
-  VISION METRON 40 CARBON
-  VISION METRON 40 CARBON
-  VITTORIA CORSA 700CX25C BROWN SIDE
-  SHIMANO ULTEGRA R8000 11s 11-30T

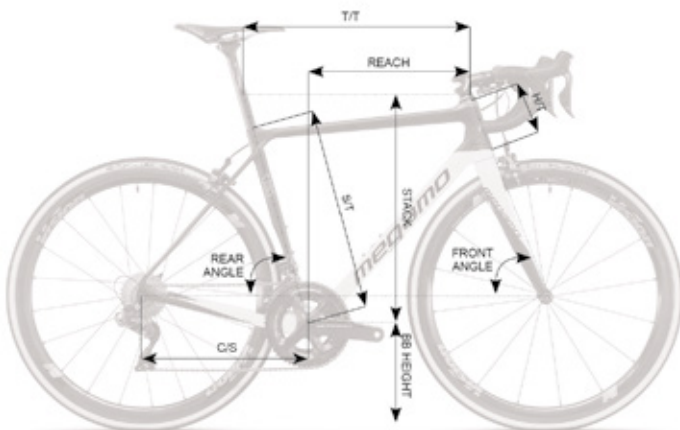











CORE 03

	XS	S	M	L	XL
SIZE	470	500	530	560	590
T/T	522	537	552	570	588
C/S	415	415	415	415	415
S/T	458	458	498	523	523
H/T	115	130	150	170	190
REACH	375	385	393	400	412
STACK	513	530	553	574	593
BB HEIGHT	274	274	274	274	274
FRONT ANGLE	71°	72°	73°	73,5°	73,5°
REAR ANGLE	74°	74°	74°	73,5°	73,5°

CORE 03 GREY



SPECIFICATIONS / ESPECIFICACIONES

-  MONOCOQUE CARBON FRAME, INTERNAL CABLE ROUTING, INTEGRATED SEAT CLAMP, Di2 SPECIFIC DESIGN
-  ADVANCED CARBON FORK DESIGN
-  FSA 1-1/8 1-1/2 * 1.5 TAPERED
-  FSA SL-K CARBON
-  FSA SL-K STEM
-  FSA SL-K CARBON 27,2
-  SELLE ITALIA SLR TITANIUM
-  SHIMANO ULTEGRA Di2 R8050 11s
-  SHIMANO ULTEGRA Di2 R8050 11s
-  SHIMANO ULTEGRA R8000 11s 52-36
-  SHIMANO ULTEGRA Di2 R8050 11s

-  SHIMANO ULTEGRA Di2 R8050 11s
-  VISION METRON 40 CARBON
-  VISION METRON 40 CARBON
-  VITTORIA CORSA 700CX25C BROWN SIDE
-  SHIMANO ULTEGRA R8000 11s 11-30T

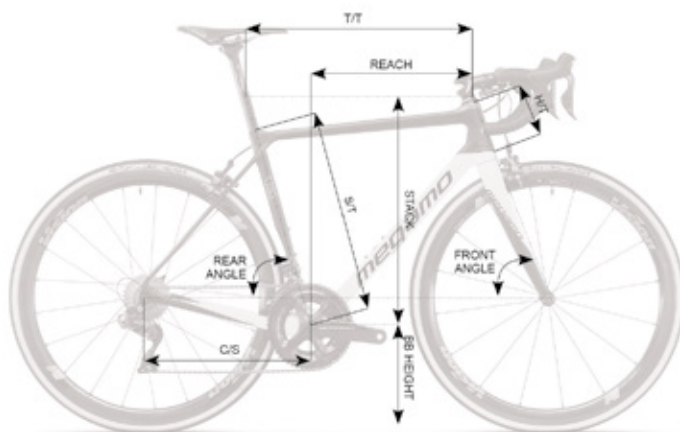

CORE 03

	XS	S	M	L	XL
SIZE	470	500	530	560	590
T/T	522	537	552	570	588
C/S	415	415	415	415	415
S/T	458	458	498	523	523
H/T	115	130	150	170	190
REACH	375	385	393	400	412
STACK	513	530	553	574	593
BB HEIGHT	274	274	274	274	274
FRONT ANGLE	71°	72°	73°	73,5°	73,5°
REAR ANGLE	74°	74°	74°	73,5°	73,5°

CORE 05 YELLOW

E-BIKES

MTB

ROAD

FAT

TREKKING











CITY





KIDS BMX

WEAR/ROPA



SPECIFICATIONS / ESPECIFICACIONES

-  MONOCOQUE CARBON FRAME, INTERNAL CABLE ROUTING, INTEGRATED SEAT CLAMP, DI2 SPECIFIC DESIGN
-  ADVANCED CARBON FORK DESIGN
-  FSA 1-1/8 1-1/2 * 1.5 TAPERED
-  FSA VERO COMPACT ROAD
-  FSA OS-168
-  FSA GOSSAMER 27,2mm
-  SELLE ITALIA X3
-  SHIMANO ULTEGRA Di2 R8050 11s
-  SHIMANO ULTEGRA Di2 R8050 11s
-  SHIMANO ULTEGRA R8000 11s 52-36
-  SHIMANO ULTEGRA Di2 R8050 11s

-  SHIMANO ULTEGRA Di2 R8050 11s
-  VISION TEAM 30 COMP
-  VISION TEAM 30 COMP
-  VITTORIA RUBINO 700CX25C
-  SHIMANO ULTEGRA R8000 11s 11-30T

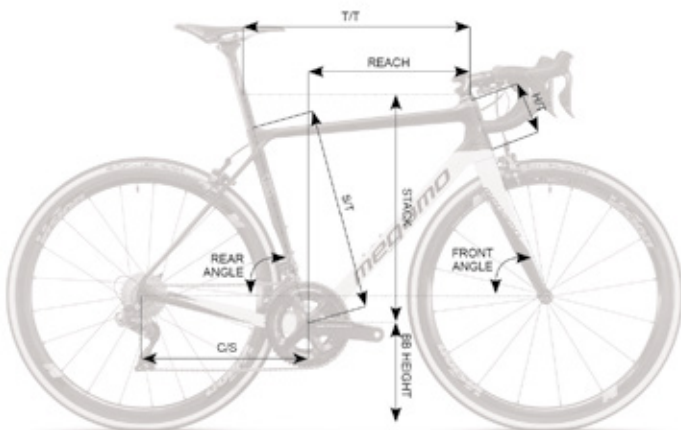











CORE 05





	XS	S	M	L	XL
SIZE	470	500	530	560	590
T/T	522	537	552	570	588
C/S	415	415	415	415	415
S/T	458	458	498	523	523
H/T	115	130	150	170	190
REACH	375	385	393	400	412
STACK	513	530	553	574	593
BB HEIGHT	274	274	274	274	274
FRONT ANGLE	71°	72°	73°	73,5°	73,5°
REAR ANGLE	74°	74°	74°	73,5°	73,5°

CORE 05 GREEN



SPECIFICATIONS / ESPECIFICACIONES

-  MONOCOQUE CARBON FRAME, INTERNAL CABLE ROUTING, INTEGRATED SEAT CLAMP, Di2 SPECIFIC DESIGN
-  ADVANCED CARBON FORK DESIGN
-  FSA 1-1/8 1-1/2 * 1.5 TAPERED
-  FSA VERO COMPACT ROAD
-  FSA OS-168
-  FSA GOSSAMER 27,2mm
-  SELLE ITALIA X3
-  SHIMANO ULTEGRA Di2 R8050 11s
-  SHIMANO ULTEGRA Di2 R8050 11s
-  SHIMANO ULTEGRA R8000 11s 52-36
-  SHIMANO ULTEGRA Di2 R8050 11s

-  SHIMANO ULTEGRA Di2 R8050 11s
-  VISION TEAM 30 COMP
-  VISION TEAM 30 COMP
-  VITTORIA RUBINO 700CX25C
-  SHIMANO ULTEGRA R8000 11s 11-30T

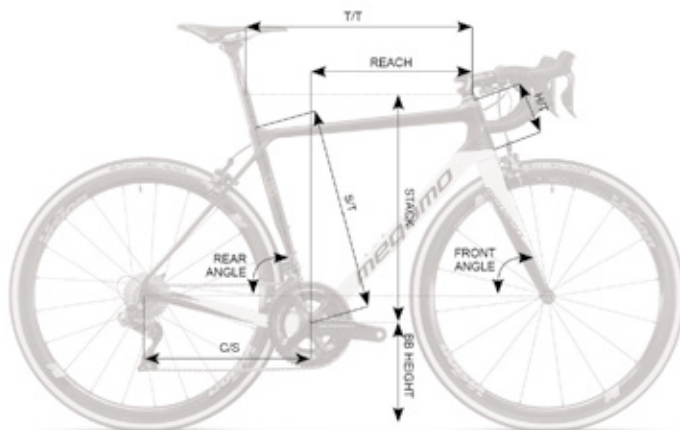

















CORE 05

	XS	S	M	L	XL
SIZE	470	500	530	560	590
T/T	522	537	552	570	588
C/S	415	415	415	415	415
S/T	458	458	498	523	523
H/T	115	130	150	170	190
REACH	375	385	393	400	412
STACK	513	530	553	574	593
BB HEIGHT	274	274	274	274	274
FRONT ANGLE	71°	72°	73°	73,5°	73,5°
REAR ANGLE	74°	74°	74°	73,5°	73,5°



SPECIFICATIONS / ESPECIFICACIONES

-  MONOCOQUE CARBON FRAME, INTERNAL CABLE ROUTING, INTEGRATED SEAT CLAMP, Di2 SPECIFIC DESIGN
-  ADVANCED CARBON FORK DESIGN
-  FSA 1-1/8 1-1/2 * 1.5 TAPERED
-  FSA VERO COMPACT ROAD
-  FSA OS-168
-  FSA GOSSAMER 27,2mm
-  SELLE ITALIA X3
-  SHIMANO ULTEGRA Di2 R8050 11s
-  SHIMANO ULTEGRA Di2 R8050 11s
-  SHIMANO ULTEGRA R8000 11s 52-36
-  SHIMANO ULTEGRA Di2 R8050 11s

-  SHIMANO ULTEGRA Di2 R8050 11s
-  VISION TEAM 30 COMP
-  VISION TEAM 30 COMP
-  VITTORIA RUBINO 700CX25C
-  SHIMANO ULTEGRA R8000 11s 11-30T

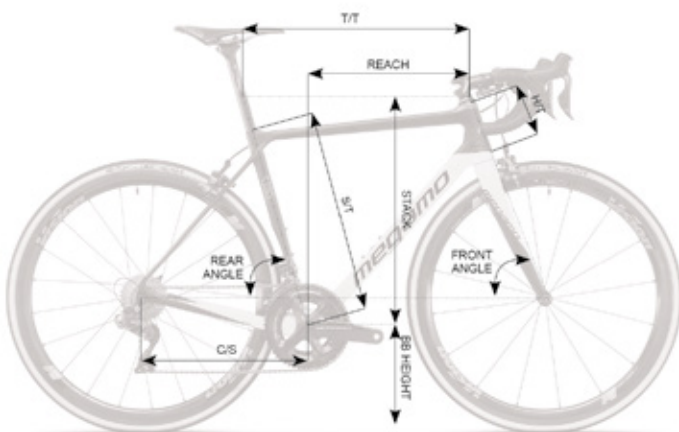

CORE 05

	XS	S	M	L	XL
SIZE	470	500	530	560	590
T/T	522	537	552	570	588
C/S	415	415	415	415	415
S/T	458	458	498	523	523
H/T	115	130	150	170	190
REACH	375	385	393	400	412
STACK	513	530	553	574	593
BB HEIGHT	274	274	274	274	274
FRONT ANGLE	71°	72°	73°	73,5°	73,5°
REAR ANGLE	74°	74°	74°	73,5°	73,5°

CORE 10 YELLOW



SPECIFICATIONS / ESPECIFICACIONES

 MONOCOQUE CARBON FRAME, INTERNAL CABLE ROUTING, INTEGRATED SEAT CLAMP, DI2 SPECIFIC DESIGN

 ADVANCED CARBON FORK DESIGN

 FSA 1-1/8 1-1/2 * 1.5 TAPERED

 FSA VERO COMPACT ROAD

 FSA OS-168

 FSA GOSSAMER 27,2mm

 SELLE ITALIA X3

 SHIMANO ULTEGRA R8000 11s

 SHIMANO ULTEGRA R8000 11s

 SHIMANO ULTEGRA R8000 11s 52-36

 SHIMANO ULTEGRA R8000 11s

 SHIMANO ULTEGRA R8000 11s

 VISION TEAM 30 COMP

 VISION TEAM 30 COMP

 VITTORIA RUBINO 700CX25C

 SHIMANO 7000 11s 11-30T

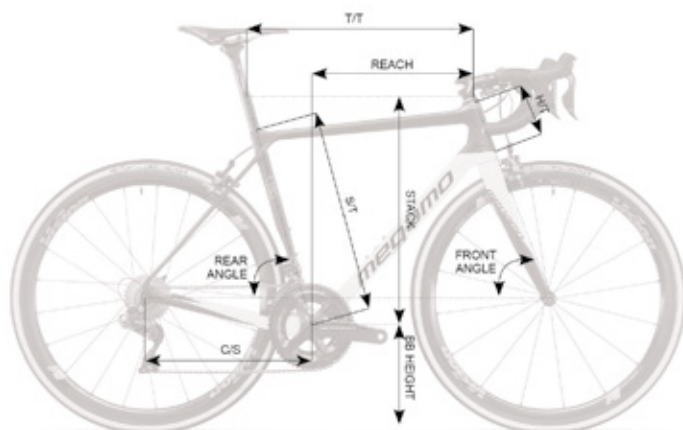

















CORE 10

	XS	S	M	L	XL
SIZE	470	500	530	560	590
T/T	522	537	552	570	588
C/S	415	415	415	415	415
S/T	458	458	498	523	523
H/T	115	130	150	170	190
REACH	375	385	393	400	412
STACK	513	530	553	574	593
BB HEIGHT	274	274	274	274	274
FRONT ANGLE	71°	72°	73°	73,5°	73,5°
REAR ANGLE	74°	74°	74°	73,5°	73,5°



SPECIFICATIONS / ESPECIFICACIONES

-  MONOCOQUE CARBON FRAME, INTERNAL CABLE ROUTING, INTEGRATED SEAT CLAMP, Di2 SPECIFIC DESIGN
-  ADVANCED CARBON FORK DESIGN
-  FSA 1-1/8 1-1/2 * 1.5 TAPERED
-  FSA VERO COMPACT ROAD
-  FSA OS-168
-  FSA GOSSAMER 27,2mm
-  SELLE ITALIA X3
-  SHIMANO ULTEGRA R8000 11s
-  SHIMANO ULTEGRA R8000 11s
-  SHIMANO ULTEGRA R8000 11s 52-36
-  SHIMANO ULTEGRA R8000 11s

-  SHIMANO ULTEGRA R8000 11s
-  VISION TEAM 30 COMP
-  VISION TEAM 30 COMP
-  VITTORIA RUBINO 700CX25C
-  SHIMANO 7000 11s 11-30T

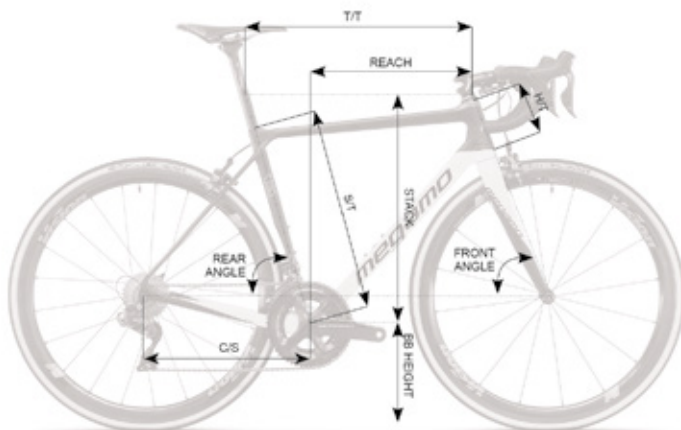

















CORE 10

	XS	S	M	L	XL
SIZE	470	500	530	560	590
T/T	522	537	552	570	588
C/S	415	415	415	415	415
S/T	458	458	498	523	523
H/T	115	130	150	170	190
REACH	375	385	393	400	412
STACK	513	530	553	574	593
BB HEIGHT	274	274	274	274	274
FRONT ANGLE	71°	72°	73°	73,5°	73,5°
REAR ANGLE	74°	74°	74°	73,5°	73,5°

CORE 10 GREY



SPECIFICATIONS / ESPECIFICACIONES

-  MONOCOQUE CARBON FRAME, INTERNAL CABLE ROUTING, INTEGRATED SEAT CLAMP, DI2 SPECIFIC DESIGN
-  ADVANCED CARBON FORK DESIGN
-  FSA 1-1/8 1-1/2 * 1.5 TAPERED
-  FSA VERO COMPACT ROAD
-  FSA OS-168
-  FSA GOSSAMER 27,2mm
-  SELLE ITALIA X3
-  SHIMANO ULTEGRA R8000 11s
-  SHIMANO ULTEGRA R8000 11s
-  SHIMANO ULTEGRA R8000 11s 52-36
-  SHIMANO ULTEGRA R8000 11s
-  SHIMANO ULTEGRA R8000 11s
-  VISION TEAM 30 COMP
-  VISION TEAM 30 COMP
-  VITTORIA RUBINO 700CX25C
-  SHIMANO 7000 11s 11-30T

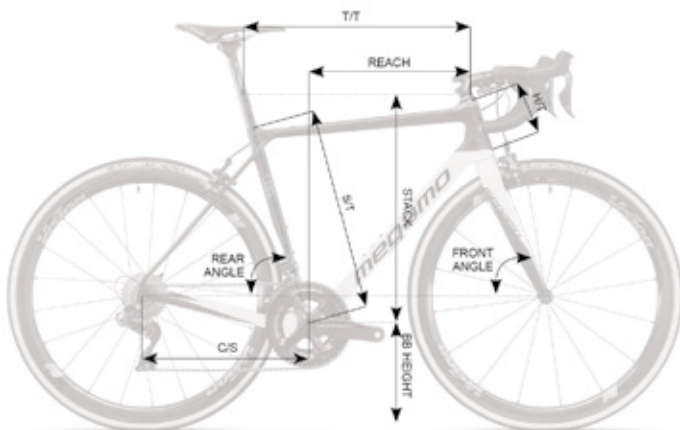

CORE 10

	XS	S	M	L	XL
SIZE	470	500	530	560	590
T/T	522	537	552	570	588
C/S	415	415	415	415	415
S/T	458	458	498	523	523
H/T	115	130	150	170	190
REACH	375	385	393	400	412
STACK	513	530	553	574	593
BB HEIGHT	274	274	274	274	274
FRONT ANGLE	71°	72°	73°	73,5°	73,5°
REAR ANGLE	74°	74°	74°	73,5°	73,5°

CORE 20 YELLOW

E-BIKES

MTB

ROAD

FAT

TREKKING











CITY





KIDS BMX

WEAR/ROPA



SPECIFICATIONS / ESPECIFICACIONES

-  MONOCOQUE CARBON FRAME, INTERNAL CABLE ROUTING, INTEGRATED SEAT CLAMP, Di2 SPECIFIC DESIGN
-  ADVANCED CARBON FORK DESIGN
-  FSA 1-1/8 1-1/2 * 1.5 TAPERED
-  MEGAMO FOV COMPACT
-  MEGAMO FOV COMPACT
-  MEGAMO 27,2mm
-  SELLE ITALIA X3
-  SHIMANO 105 7000 11s
-  SHIMANO 105 7000 11s
-  SHIMANO 7000 50-34T 11s
-  SHIMANO 7000 11s

-  SHIMANO BR 561
-  VISION TEAM 30 COMP
-  VISION TEAM 30 COMP
-  VITTORIA RUBINO 700CX25C
-  SHIMANO 7000 11-30T 11s

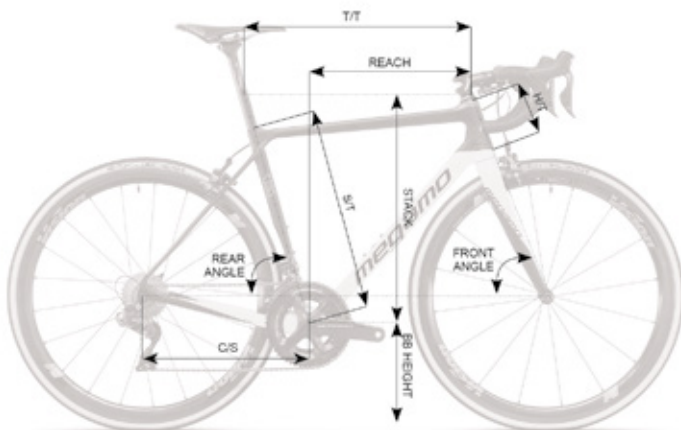











CORE 20





	XS	S	M	L	XL
SIZE	470	500	530	560	590
T/T	522	537	552	570	588
C/S	415	415	415	415	415
S/T	458	458	498	523	523
H/T	115	130	150	170	190
REACH	375	385	393	400	412
STACK	513	530	553	574	593
BB HEIGHT	274	274	274	274	274
FRONT ANGLE	71°	72°	73°	73,5°	73,5°
REAR ANGLE	74°	74°	74°	73,5°	73,5°

CORE 20 GREEN



SPECIFICATIONS / ESPECIFICACIONES

-  MONOCOQUE CARBON FRAME, INTERNAL CABLE ROUTING, INTEGRATED SEAT CLAMP, DI2 SPECIFIC DESIGN
-  ADVANCED CARBON FORK DESIGN
-  FSA 1-1/8 1-1/2 * 1.5 TAPERED
-  MEGAMO FOV COMPACT
-  MEGAMO FOV COMPACT
-  MEGAMO 27,2mm
-  SELLE ITALIA X3
-  SHIMANO 105 7000 11s
-  SHIMANO 105 7000 11s
-  SHIMANO 7000 50-34T 11s
-  SHIMANO 7000 11s

-  SHIMANO BR 561
-  VISION TEAM 30 COMP
-  VISION TEAM 30 COMP
-  VITTORIA RUBINO 700CX25C
-  SHIMANO 7000 11-30T 11s

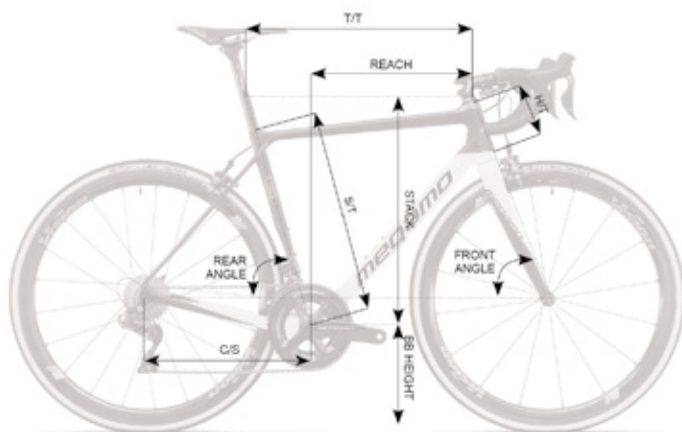

















CORE 20

	XS	S	M	L	XL
SIZE	470	500	530	560	590
T/T	522	537	552	570	588
C/S	415	415	415	415	415
S/T	458	458	498	523	523
H/T	115	130	150	170	190
REACH	375	385	393	400	412
STACK	513	530	553	574	593
BB HEIGHT	274	274	274	274	274
FRONT ANGLE	71°	72°	73°	73,5°	73,5°
REAR ANGLE	74°	74°	74°	73,5°	73,5°



SPECIFICATIONS / ESPECIFICACIONES

-  MONOCOQUE CARBON FRAME, INTERNAL CABLE ROUTING, INTEGRATED SEAT CLAMP, Di2 SPECIFIC DESIGN
-  ADVANCED CARBON FORK DESIGN
-  FSA 1-1/8 1-1/2 * 1.5 TAPERED
-  MEGAMO FOV COMPACT
-  MEGAMO FOV COMPACT
-  MEGAMO 27,2mm
-  SELLE ITALIA X3
-  SHIMANO 105 7000 11s
-  SHIMANO 105 7000 11s
-  SHIMANO 7000 50-34T 11s
-  SHIMANO 7000 11s

-  SHIMANO BR 561
-  VISION TEAM 30 COMP
-  VISION TEAM 30 COMP
-  VITTORIA RUBINO 700CX25C
-  SHIMANO 7000 11-30T 11s

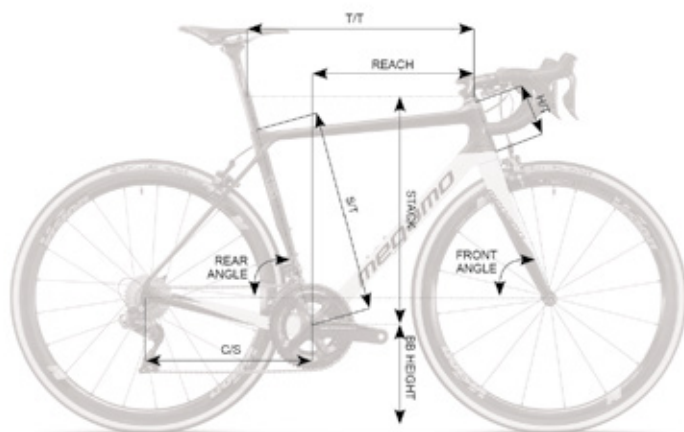











CORE 20





	XS	S	M	L	XL
SIZE	470	500	530	560	590
T/T	522	537	552	570	588
C/S	415	415	415	415	415
S/T	458	458	498	523	523
H/T	115	130	150	170	190
REACH	375	385	393	400	412
STACK	513	530	553	574	593
BB HEIGHT	274	274	274	274	274
FRONT ANGLE	71°	72°	73°	73,5°	73,5°
REAR ANGLE	74°	74°	74°	73,5°	73,5°

CORE 30 YELLOW



SPECIFICATIONS / ESPECIFICACIONES

	MONOCOQUE CARBON FRAME, INTERNAL CABLE ROUTING, INTEGRATED SEAT CLAMP, DI2 SPECIFIC DESIGN
	ADVANCED CARBON FORK DESIGN
	FSA 1-1/8 1-1/2 * 1.5 TAPERED
	MEGAMO FOV COMPACT
	MEGAMO FOV COMPACT
	MEGAMO 27,2mm
	SELLE ITALIA X3
	SHIMANO 105 7000 11s
	SHIMANO 105 7000 11s
	SHIMANO 7000 50-34T 11s
	SHIMANO 7000 11s

	SHIMANO BR 561
	SHIMANO RS
	SHIMANO RS
	VITTORIA RUBINO 700CX25C
	SHIMANO 7000 11-30T 11s

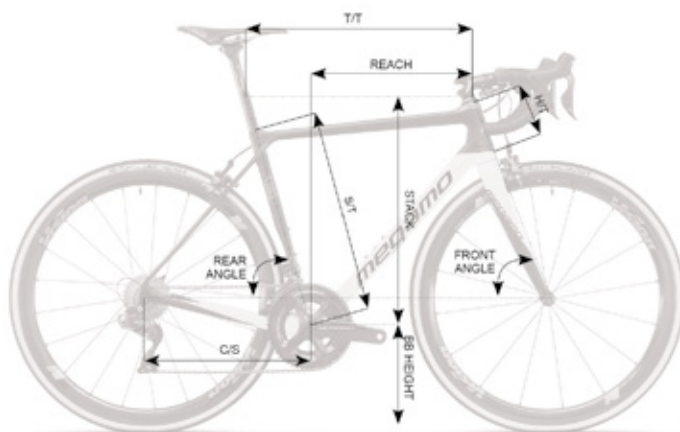

CORE 30

	XS	S	M	L	XL
SIZE	470	500	530	560	590
T/T	522	537	552	570	588
C/S	415	415	415	415	415
S/T	458	458	498	523	523
H/T	115	130	150	170	190
REACH	375	385	393	400	412
STACK	513	530	553	574	593
BB HEIGHT	274	274	274	274	274
FRONT ANGLE	71°	72°	73°	73,5°	73,5°
REAR ANGLE	74°	74°	74°	73,5°	73,5°

CORE 30 GREEN

E-BIKES

MTB

ROAD

FAT

TREKKING











CITY





KIDS BMX

WEAR/ROPA



SPECIFICATIONS / ESPECIFICACIONES

-  MONOCOQUE CARBON FRAME, INTERNAL CABLE ROUTING, INTEGRATED SEAT CLAMP, Di2 SPECIFIC DESIGN
-  ADVANCED CARBON FORK DESIGN
-  FSA 1-1/8 1-1/2 * 1.5 TAPERED
-  MEGAMO FOV COMPACT
-  MEGAMO FOV COMPACT
-  MEGAMO 27,2mm
-  SELLE ITALIA X3
-  SHIMANO 105 7000 11s
-  SHIMANO 105 7000 11s
-  SHIMANO 7000 50-34T 11s
-  SHIMANO 7000 11s

-  SHIMANO BR 561
-  SHIMANO RS
-  SHIMANO RS
-  VITTORIA RUBINO 700CX25C
-  SHIMANO 7000 11-30T 11s

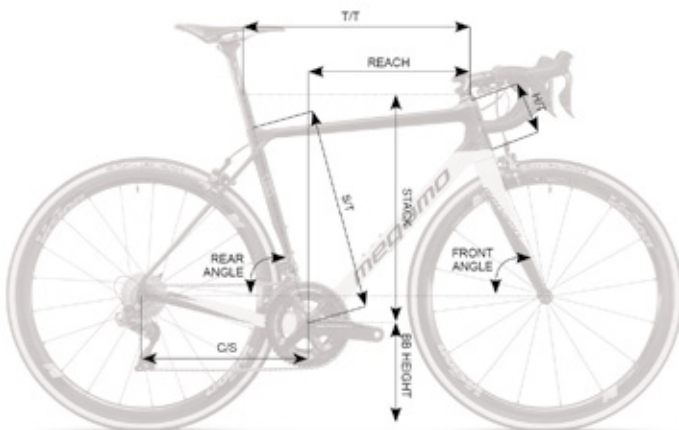

















CORE 30

	XS	S	M	L	XL
SIZE	470	500	530	560	590
T/T	522	537	552	570	588
C/S	415	415	415	415	415
S/T	458	458	498	523	523
H/T	115	130	150	170	190
REACH	375	385	393	400	412
STACK	513	530	553	574	593
BB HEIGHT	274	274	274	274	274
FRONT ANGLE	71°	72°	73°	73,5°	73,5°
REAR ANGLE	74°	74°	74°	73,5°	73,5°

CORE 30 GREY



SPECIFICATIONS / ESPECIFICACIONES

 MONOCOQUE CARBON FRAME, INTERNAL CABLE ROUTING, INTEGRATED SEAT CLAMP, DI2 SPECIFIC DESIGN	 SHIMANO BR 561
 ADVANCED CARBON FORK DESIGN	 SHIMANO RS
 FSA 1-1/8 1-1/2 * 1.5 TAPERED	 SHIMANO RS
 MEGAMO FOV COMPACT	 VITTORIA RUBINO 700CX25C
 MEGAMO FOV COMPACT	 SHIMANO 7000 11-30T 11s
 MEGAMO 27,2mm	
 SELLE ITALIA X3	
 SHIMANO 105 7000 11s	
 SHIMANO 105 7000 11s	
 SHIMANO 7000 50-34T 11s	
 SHIMANO 7000 11s	

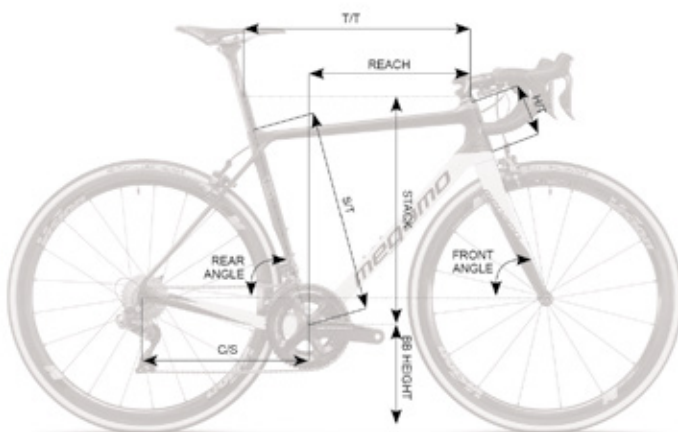

CORE 30

	XS	S	M	L	XL
SIZE	470	500	530	560	590
T/T	522	537	552	570	588
C/S	415	415	415	415	415
S/T	458	458	498	523	523
H/T	115	130	150	170	190
REACH	375	385	393	400	412
STACK	513	530	553	574	593
BB HEIGHT	274	274	274	274	274
FRONT ANGLE	71°	72°	73°	73,5°	73,5°
REAR ANGLE	74°	74°	74°	73,5°	73,5°



WEAR/ROPA

KIDS BMX

CITY

TREKKING

FAT

ROAD











MTB

E-BIKES

R10 105 ORANGE



SPECIFICATIONS / ESPECIFICACIONES

-  ALLOY 6061 TRIPLE BUTTED, HYDROFORMED TECHNOLOGY
INTERNAL CABLE ROUTING, EFFICIENCY PEDALING
-  ADVANCED CARBON FORK
-  FSA ORBIT - Z 1 - 1/8" SEMI INTEGRATED
-  MEGAMO FOV COMPACT
-  MEGAMO FOV
-  MEGAMO
-  MEGAMO
-  SHIMANO 105 RD-55800 11s
-  SHIMANO 105 RD-55800 11s
-  SHIMANO RS 500 DB04L 50-34 T
-  SHIMANO 105 RD-55800 11s

-  SHIMANO 105 RD-55800 11s
-  SHIMANO RS400 28H
-  MEGAMO AERO 30MM
-  VITTORIA ZAFFIRO 700CX25C
-  SHIMANO KCS 5800 - 11s 11-28 T

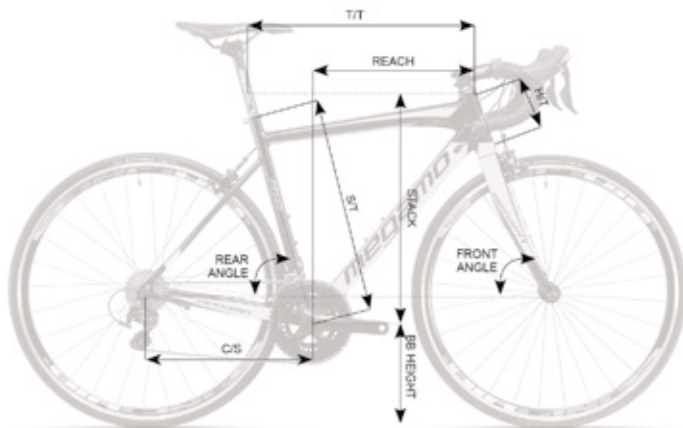

















R10 105

	XS	S	M	L	XL
SIZE	-	-	-	-	-
T/T	500	525	545	565	590
C/S	405	405	405	405	405
S/T	470	500	530	560	590
H/T	120	140	160	180	210
REACH	362	375	384	390	409
STACK	515	539	560	590	612
BB HEIGHT	-	-	-	-	-
FRONT ANGLE	70,5	72	72,5	73	73,5
REAR ANGLE	75	74,5	74	73,5	73,5



SPECIFICATIONS / ESPECIFICACIONES

-  ALLOY 6061 TRIPLE BUTTED, HYDROFORMED TECHNOLOGY
INTERNAL CABLE ROUTING, EFFICIENCY PEDALING
-  ADVANCED CARBON FORK
-  FSA ORBIT - Z1-1/8" SEMI INTEGRATED
-  MEGAMO FOV COMPACT
-  MEGAMO FOV
-  MEGAMO
-  MEGAMO
-  SHIMANO 105 RD-55800 11s
-  SHIMANO 105 RD-55800 11s
-  SHIMANO RS 500 DB04L 50-34 T
-  SHIMANO 105 RD-55800 11s

-  SHIMANO 105 RD-55800 11s
-  SHIMANO RS400 28H
-  MEGAMO AERO 30MM
-  VITTORIA ZAFFIRO 700CX25C
-  SHIMANO KCS 5800 - 11s 11-28 T

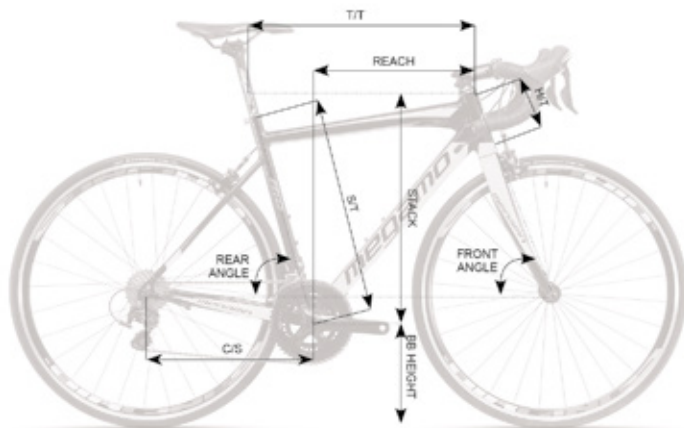

R10 105

	XS	S	M	L	XL
SIZE	-	-	-	-	-
T/T	500	525	545	565	590
C/S	405	405	405	405	405
S/T	470	500	530	560	590
H/T	120	140	160	180	210
REACH	362	375	384	390	409
STACK	515	539	560	590	612
BB HEIGHT	-	-	-	-	-
FRONT ANGLE	70,5	72	72,5	73	73,5
REAR ANGLE	75	74,5	74	73,5	73,5

R10 105 GREEN



SPECIFICATIONS / ESPECIFICACIONES

 ALLOY 6061 TRIPLE BUTTED, HYDROFORMED TECHNOLOGY
INTERNAL CABLE ROUTING, EFFICIENCY PEDALING

 ADVANCED CARBON FORK

 FSA ORBIT - Z1-1/8" SEMI INTEGRATED

 MEGAMO FOV COMPACT

 MEGAMO FOV

 MEGAMO

 MEGAMO

 SHIMANO 105 RD-55800 11s

 SHIMANO 105 RD-55800 11s

 SHIMANO RS 500 DB04L 50-34 T

 SHIMANO 105 RD-55800 11s

 SHIMANO 105 RD-55800 11s

 SHIMANO RS400 28H

 MEGAMO AERO 30MM

 VITTORIA ZAFFIRO 700CX25C

 SHIMANO KCS 5800 - 11s 11-28 T

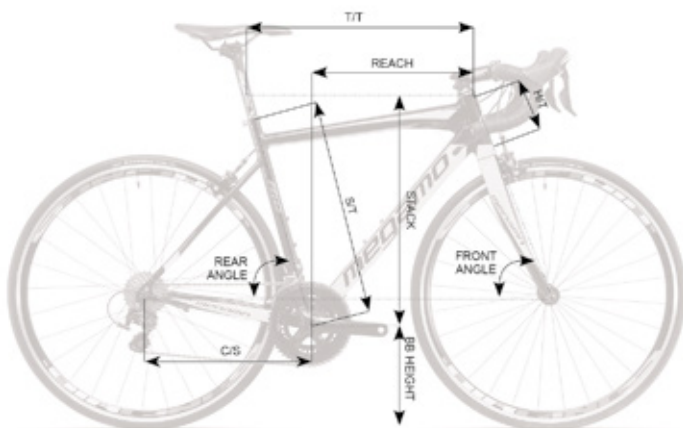

R10 105

	XS	S	M	L	XL
SIZE	-	-	-	-	-
T/T	500	525	545	565	590
C/S	405	405	405	405	405
S/T	470	500	530	560	590
H/T	120	140	160	180	210
REACH	362	375	384	390	409
STACK	515	539	560	590	612
BB HEIGHT	-	-	-	-	-
FRONT ANGLE	70,5	72	72,5	73	73,5
REAR ANGLE	75	74,5	74	73,5	73,5

R10 TIAGRA ORANGE

E-BIKES

MTB

ROAD

FAT

TREKKING

CITY

KIDS BMX

WEAR/ROPA



SPECIFICATIONS / ESPECIFICACIONES

 ALLOY 6061 TRIPLE BUTTED, HYDROFORMED TECHNOLOGY
INTERNAL CABLE ROUTING, EFFICIENCY PEDALING

 ADVANCED CARBON FORK

 FSA ORBIT - Z1-1/8" SEMI INTEGRATED

 MEGAMO FOV COMPACT

 MEGAMO FOV

 MEGAMO

 MEGAMO

 SHIMANO TIAGRA RD-4700

 SHIMANO TIAGRA RD-4700

 SHIMANO TIAGRA RD-4700

 SHIMANO TIAGRA RD-4700

 SHIMANO TIAGRA RD-4700

 SHIMANO RS400 28H

 MEGAMO AERO 30MM

 VITTORIA ZAFFIRO 700CX25C

 SHIMANO HG50 - 10s 12-28 T

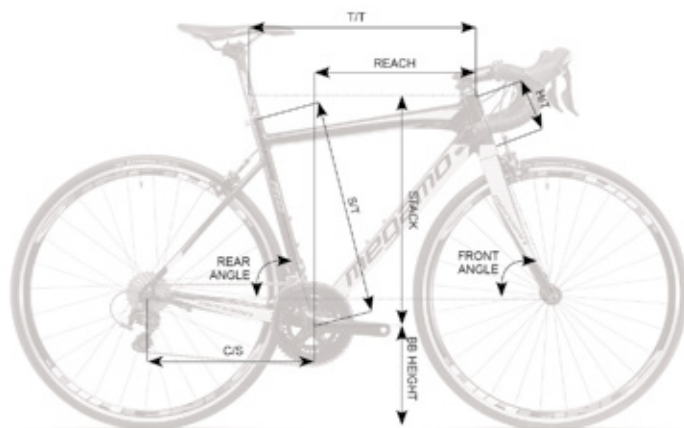

















R10 TIAGRA

	XS	S	M	L	XL
SIZE	-	-	-	-	-
T/T	500	525	545	565	590
C/S	405	405	405	405	405
S/T	470	500	530	560	590
H/T	120	140	160	180	210
REACH	362	375	384	390	409
STACK	515	539	560	590	612
BB HEIGHT	-	-	-	-	-
FRONT ANGLE	70,5	72	72,5	73	73,5
REAR ANGLE	75	74,5	74	73,5	73,5

R10 TIAGRA GREY



SPECIFICATIONS / ESPECIFICACIONES

 ALLOY 6061 TRIPLE BUTTED, HYDROFORMED TECHNOLOGY INTERNAL CABLE ROUTING, EFFICIENCY PEDALING	 SHIMANO TIAGRA RD-4700
 ADVANCED CARBON FORK	 SHIMANO RS400 28H
 FSA ORBIT - Z1-1/8" SEMI INTEGRATED	 MEGAMO AERO 30MM
 MEGAMO FOV COMPACT	 VITTORIA ZAFFIRO 700CX25C
 MEGAMO FOV	 SHIMANO HG50 - 10s 12-28 T
 MEGAMO	
 MEGAMO	
 SHIMANO TIAGRA RD-4700	
 SHIMANO TIAGRA RD-4700	
 SHIMANO TIAGRA RD-4700	
 SHIMANO TIAGRA RD-4700	

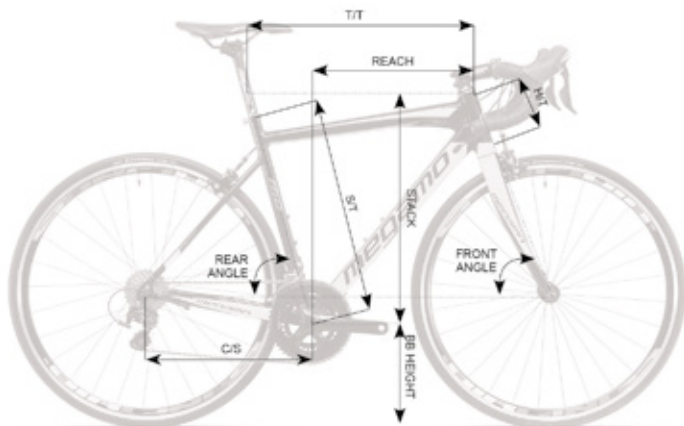

R10 TIAGRA

	XS	S	M	L	XL
SIZE	-	-	-	-	-
T/T	500	525	545	565	590
C/S	405	405	405	405	405
S/T	470	500	530	560	590
H/T	120	140	160	180	210
REACH	362	375	384	390	409
STACK	515	539	560	590	612
BB HEIGHT	-	-	-	-	-
FRONT ANGLE	70,5	72	72,5	73	73,5
REAR ANGLE	75	74,5	74	73,5	73,5

R10 TIAGRA GREEN

E-BIKES

MTB

ROAD

FAT

TREKKING

CITY

KIDS BMX

WEAR/ROPA



SPECIFICATIONS / ESPECIFICACIONES

 ALLOY 6061 TRIPLE BUTTED, HYDROFORMED TECHNOLOGY
INTERNAL CABLE ROUTING, EFFICIENCY PEDALING

 ADVANCED CARBON FORK

 FSA ORBIT - Z1-1/8" SEMI INTEGRATED

 MEGAMO FOV COMPACT

 MEGAMO FOV

 MEGAMO

 MEGAMO

 SHIMANO TIAGRA RD-4700

 SHIMANO TIAGRA RD-4700

 SHIMANO TIAGRA RD-4700

 SHIMANO TIAGRA RD-4700

 SHIMANO TIAGRA RD-4700

 SHIMANO RS400 28H

 MEGAMO AERO 30MM

 VITTORIA ZAFFIRO 700CX25C

 SHIMANO HG50 - 10s 12-28 T

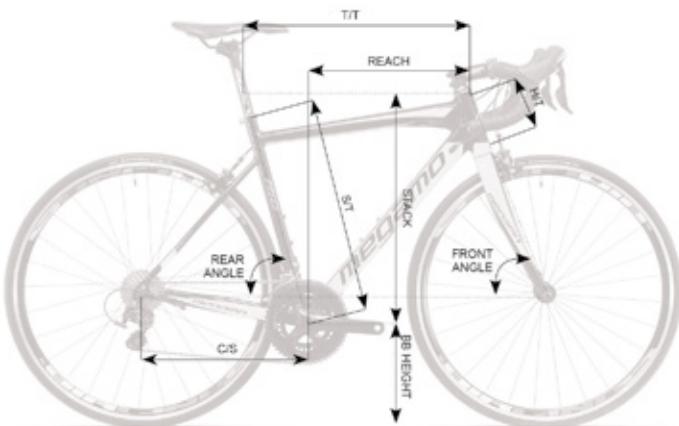

R10 TIAGRA

	XS	S	M	L	XL
SIZE	-	-	-	-	-
T/T	500	525	545	565	590
C/S	405	405	405	405	405
S/T	470	500	530	560	590
H/T	120	140	160	180	210
REACH	362	375	384	390	409
STACK	515	539	560	590	612
BB HEIGHT	-	-	-	-	-
FRONT ANGLE	70,5	72	72,5	73	73,5
REAR ANGLE	75	74,5	74	73,5	73,5





WEAR/ROPA

KIDS BMX

CITY

TREKKING

FAT

ROAD

MTB

E-BIKES

GRAVE 10 ORANGE



SPECIFICATIONS / ESPECIFICACIONES

 ALLOY 6061 TRIPLE BUTTED, HYDROFORMED TECHNOLOGY
INTERNAL CABLE ROUTING, SPECIFIC GRAVEL GEOMETRY

 ADVANCED CARBON FORK, FLAT MOUNT BRAKES, THRU AXLE
12X100

 FSA 1-1/8 1-1/2 * 1.5 TAPERED

 MEGAMO FOV COMPACT GRAVEL STYLE

 MEGAMO FOV COMPACT

 MEGAMO 27,2mm

 MEGAMO

 SHIMANO 105 7000 11s

 SHIMANO 105 7000 11s

 SHIMANO FC-RS510 50-34T

 SHIMANO 105 7020 11s

 SHIMANO 105 7070 11s HYDRAULIC DISC

 MEGAMO GRAVEL 12x100 / 12x142

 MEGAMO GRAVEL 12x100 / 12x142

 WTB 700x40C

 SHIMANO 105 7000 11-32T 11s

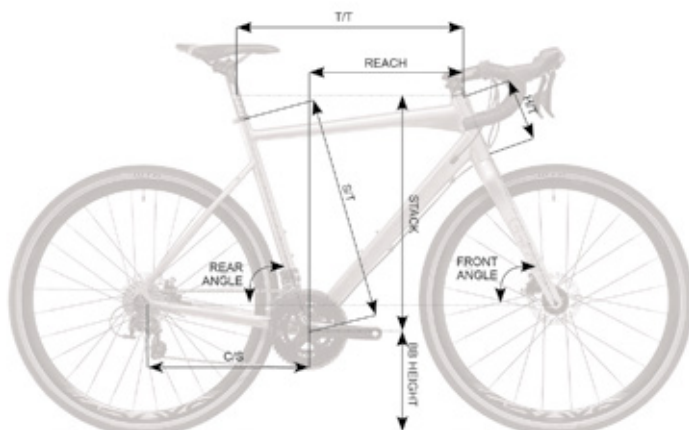

GRAVE 10

	S	M	L
SIZE	500	530	570
T/T	515	545	575
C/S	430	430	430
S/T	500	530	570
H/T	125	145	175
REACH	359	378	394
STACK	545	565	594
BB HEIGHT	280	280	280
FRONT ANGLE	70,5	71	71
REAR ANGLE	74	73,5	73

GRAVE 10 BLACK

E-BIKES

MTB

ROAD

FAT

TREKKING

CITY

KIDS BMX

WEAR/ROPA



SPECIFICATIONS / ESPECIFICACIONES

 ALLOY 6061 TRIPLE BUTTED, HYDROFORMED TECHNOLOGY
INTERNAL CABLE ROUTING, SPECIFIC GRAVEL GEOMETRY

 ADVANCED CARBON FORK, FLAT MOUNT BRAKES, THRU AXLE
12X100

 FSA 1-1/8 1-1/2 * 1.5 TAPERED

 MEGAMO FOV COMPACT GRAVEL STYLE

 MEGAMO FOV COMPACT

 MEGAMO 27,2mm

 MEGAMO

 SHIMANO 105 7000 11s

 SHIMANO 105 7000 11s

 SHIMANO FC-RS510 50-34T

 SHIMANO 105 7020 11s

 SHIMANO 105 7070 11s HYDRAULIC DISC

 MEGAMO GRAVEL 12x100 / 12x142

 MEGAMO GRAVEL 12x100 / 12x142

 WTB 700x40C

 SHIMANO 105 7000 11-32T 11s

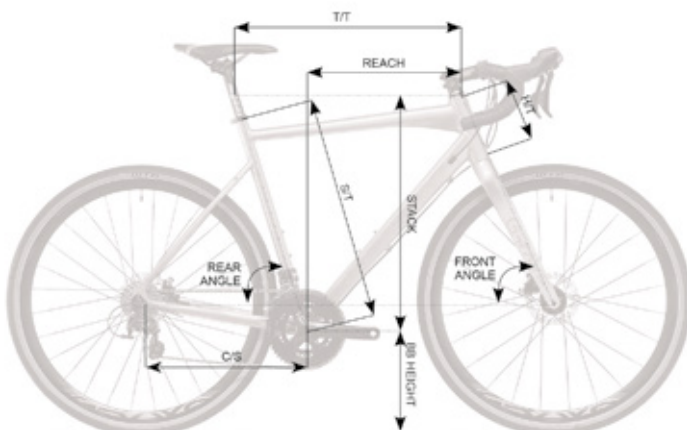

















GRAVE 10

	S	M	L
SIZE	500	530	570
T/T	515	545	575
C/S	430	430	430
S/T	500	530	570
H/T	125	145	175
REACH	359	378	394
STACK	545	565	594
BB HEIGHT	280	280	280
FRONT ANGLE	70,5	71	71
REAR ANGLE	74	73,5	73

GRAVE 20 ORANGE



SPECIFICATIONS / ESPECIFICACIONES

 ALLOY 6061 TRIPLE BUTTED, HYDROFORMED TECHNOLOGY INTERNAL CABLE ROUTING, SPECIFIC GRAVEL GEOMETRY	 SHIMANO RS505 HYDRAULIC DISC
 ADVANCED CARBON FORK, FLAT MOUNT BRAKES, THRU AXLE 12X100	 MEGAMO GRAVEL 12x100 / 12x142
 FSA 1-1/8 1-1/2 * 1.5 TAPERED	 MEGAMO GRAVEL 12x100 / 12x142
 MEGAMO FOV COMPACT GRAVEL STYLE	 WTB 700x40C
 MEGAMO FOV COMPACT	 SHIMANO TIAGRA 4700 10s
 MEGAMO 27,2mm	
 MEGAMO	
 SHIMANO TIAGRA 4700 10s	
 SHIMANO TIAGRA 4700 10s	
 SHIMANO TIAGRA 4700 10s	
 SHIMANO RS505 HYDRAULIC DISC	

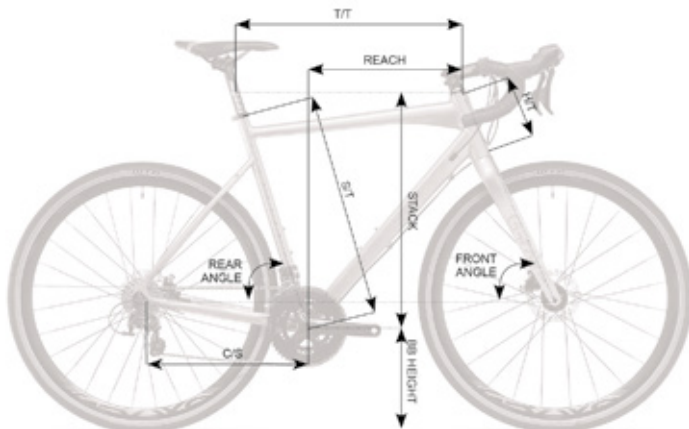











GRAVE 20

	S	M	L
SIZE	500	530	570
T/T	515	545	575
C/S	430	430	430
S/T	500	530	570
H/T	125	145	175
REACH	359	378	394
STACK	545	565	594
BB HEIGHT	280	280	280
FRONT ANGLE	70,5	71	71
REAR ANGLE	74	73,5	73

GRAVE 20 BLACK



SPECIFICATIONS / ESPECIFICACIONES

-  ALLOY 6061 TRIPLE BUTTED, HYDROFORMED TECHNOLOGY
INTERNAL CABLE ROUTING, SPECIFIC GRAVEL GEOMETRY
-  ADVANCED CARBON FORK, FLAT MOUNT BRAKES, THRU AXLE
12X100
-  FSA 1-1/8 1-1/2 * 1.5 TAPERED
-  MEGAMO FOV COMPACT GRAVEL STYLE
-  MEGAMO FOV COMPACT
-  MEGAMO 27,2mm
-  MEGAMO
-  SHIMANO TIAGRA 4700 10s
-  SHIMANO TIAGRA 4700 10s
-  SHIMANO TIAGRA 4700 10s
-  SHIMANO RS505 HYDRAULIC DISC

-  SHIMANO RS505 HYDRAULIC DISC
-  MEGAMO GRAVEL 12x100 / 12x142
-  MEGAMO GRAVEL 12x100 / 12x142
-  WTB 700x40C
-  SHIMANO TIAGRA 4700 10s

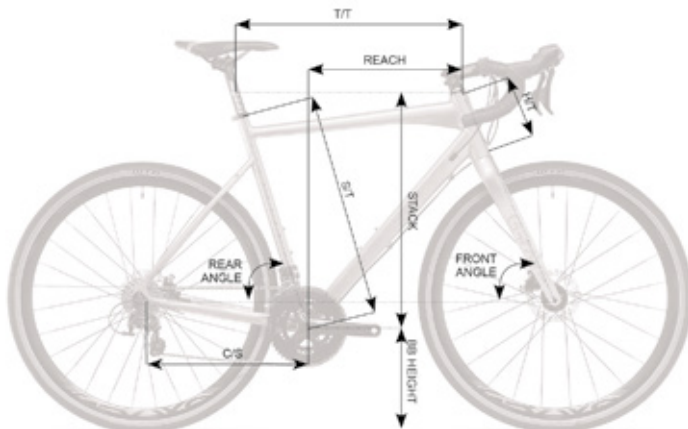

GRAVE 20

	S	M	L
SIZE	500	530	570
T/T	515	545	575
C/S	430	430	430
S/T	500	530	570
H/T	125	145	175
REACH	359	378	394
STACK	545	565	594
BB HEIGHT	280	280	280
FRONT ANGLE	70,5	71	71
REAR ANGLE	74	73,5	73





megamo











FAT



<i>GREAT</i>	240
<i>TANK ORANGE / YELLOW</i>	241-242
<i>JUNGLE</i>	243





SPECIFICATIONS / ESPECIFICACIONES

	ALLOY 6061 FAT HYDROFORMED
	FAT ALLOY DISC
	CH-9190 1-1/8" SEMI INTEGRATED
	MEGAMO SP-102 FOV W:740mm
	MEGAMO SP-369 FOV W: 70mm
	MEGAMO SP-208 30.4x350mm
	MEGAMO
	SHIMANO ACERA 3000
	SHIMANO 370
	SHIMANO 371
	SHIMANO 370

	SHIMANO M-315 HYDRAULIC
	FAT 135/180mm
	26 FAT 84,5mm 36H
	26" x 4" FAT
	SHIMANO HG-20 9s 11-32T

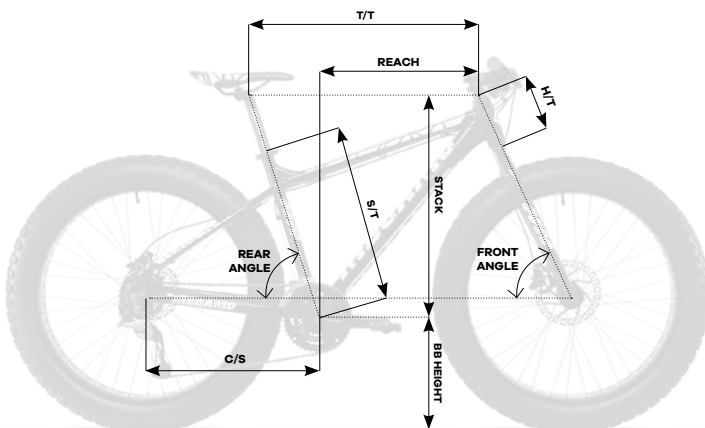











GREAT





26"

	M	L
SIZE	18"	20"
T/T	610	625
C/S	455	455
S/T	450	508
H/T	120	130
REACH	438	450
STACK	563	573
BB HEIGHT	314	314
FRONT ANGLE	70°	70°
REAR ANGLE	73°	73°



SPECIFICATIONS / ESPECIFICACIONES

-  ALLOY 6061 FAT HYDROFORMED
-  FAT ALLOY DISC
-  CH-9190 1-1/8" SEMI INTEGRATED
-  MEGAMO SP-510 FOV W:740mm
-  MEGAMO SP-369 FOV W: 70mm
-  MEGAMO SP-208 30.4x350mm
-  MEGAMO
-  SHIMANO ALTUS 310
-  SHIMANO TX800
-  SHIMANO TX801 42-32-22T
-  SHIMANO M310

-  SHIMANO M-315 HYDRAULIC
-  FAT 135/180mm
-  26" FAT 36 H
-  26" x 4" FAT
-  SHIMANO HG-20 8s 12-32T

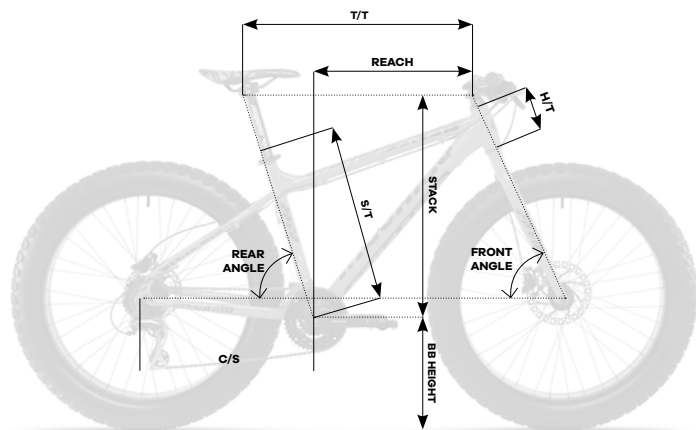

TANK

















26"

	M	L
SIZE	18"	20"
T/T	610	625
C/S	455	455
S/T	450	508
H/T	120	130
REACH	438	450
STACK	563	573
BB HEIGHT	314	314
FRONT ANGLE	70°	70°
REAR ANGLE	73°	73°

TANK YELLOW



SPECIFICATIONS / ESPECIFICACIONES

 ALLOY 6061 FAT HYDROFORMED	 SHIMANO M-315 HYDRAULIC
 FAT ALLOY DISC	 FAT 135/180mm
 CH-9190 1-1/8" SEMI INTEGRATED	 26" FAT 36 H
 MEGAMO SP-510 FOV W:740mm	 26" x 4" FAT
 MEGAMO SP-369 FOV W: 70mm	 SHIMANO HG-20 8s 12-32T
 MEGAMO SP-208 30.4x350mm	
 MEGAMO	
 SHIMANO ALTUS 310	
 SHIMANO TX800	
 SHIMANO TX801 42-32-22T	
 SHIMANO M310	

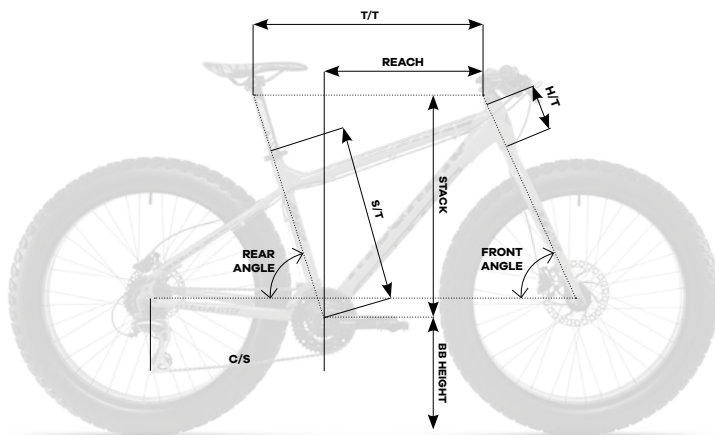











TANK





26"

	M	L
SIZE	18"	20"
T/T	610	625
C/S	455	455
S/T	450	508
H/T	120	130
REACH	438	450
STACK	563	573
BB HEIGHT	314	314
FRONT ANGLE	70°	70°
REAR ANGLE	73°	73°



SPECIFICATIONS / ESPECIFICACIONES

-  ALLOY 6061 FAT HYDROFORMED
-  FAT ALLOY DISC
-  CH-9190 1-1/8" SEMI INTEGRATED
-  MEGAMO 31,8 FOV
-  MEGAMO ALLOY 31,8 FOV
-  MEGAMO ALLOY 27,2
-  MEGAMO
-  SHIMANO TY2155B
-  PROWHEEL 116PP
-  SHIMANO RS36 6s

-  338 ALLOY
-  MEGAMO FAT
-  MEGAMO ALLOY FAT
-  MEGAMO 20 x 4"
-  SHIMANO 6s

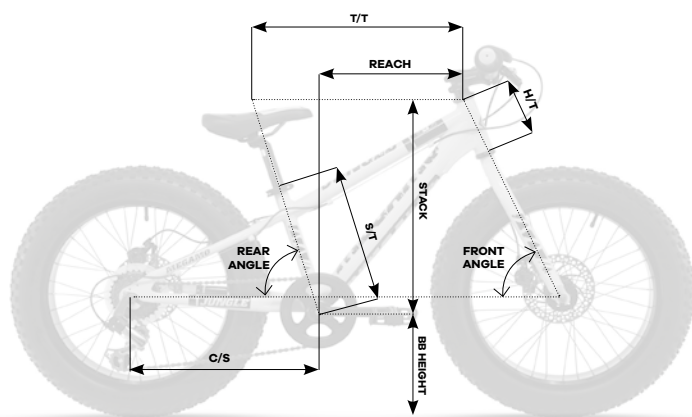

JUNGLE 20"

	onesize
SIZE	11"
T/T	466
C/S	380
S/T	280
H/T	120
REACH	320
STACK	449
BB HEIGHT	260
FRONT ANGLE	69°
REAR ANGLE	72°





megamo

TREKKING

ADVENTURE 10.....	246
ADVENTURE 20.....	247
28 TACAMA.....	248
26 KIBO.....	249



ADVENTURE 10



SPECIFICATIONS / ESPECIFICACIONES

 ALLOY 6061, HYDROFORMED TUBBING, INTERNAL CABLE ROUTING

 SUNTOUR NEX ADJUSTABLE PRELOAD 80m/m

 OVERSIZE

 MEGAMO ALLOY

 MEGAMO ALLOY

 MEGAMO ALLOY

 MEGAMO

 SHIMANO TX800

 SHIMANO TX800

 SHIMANO TX800

 SHIMANO TX800

 SHIMANO 315 HYDRAULIC DISCS

 FORMULA

 MEGAMO ALLOY DISC

 700 TREKKING

 SHIMANO TX800 8s

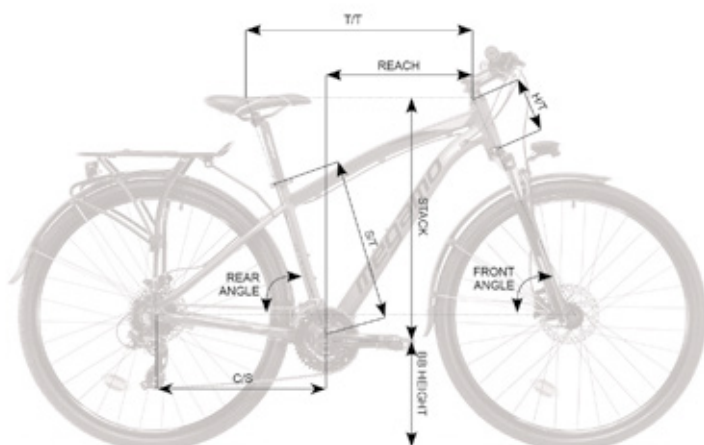











ADVENTURE 10

	M	L
SIZE	17"	19"
T/T	576	610
C/S	450	450
S/T	430	480
H/T	120	140
REACH	400	431
STACK	613	633
BB HEIGHT	283	283
FRONT ANGLE	70,5°	70,5°
REAR ANGLE	74	74



SPECIFICATIONS / ESPECIFICACIONES

-  ALLOY 6061, HYDROFORMED TUBBING, INTERNAL CABLE ROUTING
-  SUNTOUR NEX ADJUSTABLE PRELOAD 80m/m
-  OVERSIZE
-  MEGAMO ALLOY
-  MEGAMO ALLOY
-  MEGAMO ALLOY
-  MEGAMO
-  SHIMANO TX800
-  SHIMANO TZ30
-  PROWHEEL /920
-  SHIMANO EF41

-  SHIMANO EF41
-  FORMULA
-  ALLOY 700C
-  700x38c TREKKING
-  SHIMANO TZ21 7s

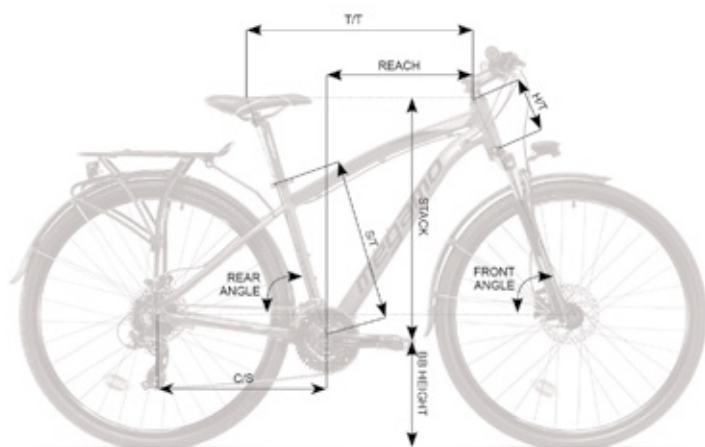

ADVENTURE 20

	M	L
SIZE	17"	19"
T/T	576	610
C/S	450	450
S/T	430	480
H/T	120	140
REACH	400	431
STACK	613	633
BB HEIGHT	283	283
FRONT ANGLE	70,5°	70,5°
REAR ANGLE	74	74

28 TACAMA



SPECIFICATIONS / ESPECIFICACIONES

	TREKKING ALLOY 6061
	TREKKING SUSPENSION 80mm
	CH-9080 OVERSIZE
	TREKKING 620mm
	ALLOY 235 REGULABLE 25.4x150x90mm
	ALLOY 27.2x350mm
	MEGAMO TREKKING
	SHIMANO TX35
	SHIMANO TZ30
	PROWHEEL 920 ALLOY 42-32-22T
	SHIMANO RS35

	V-BRAKE ALLOY
	FORMULA ALLOY FM21 FM31 36H
	ALLOY SCOUT
	TREKKING 1.75
	SHIMANO TZ21 7s 14-28 T

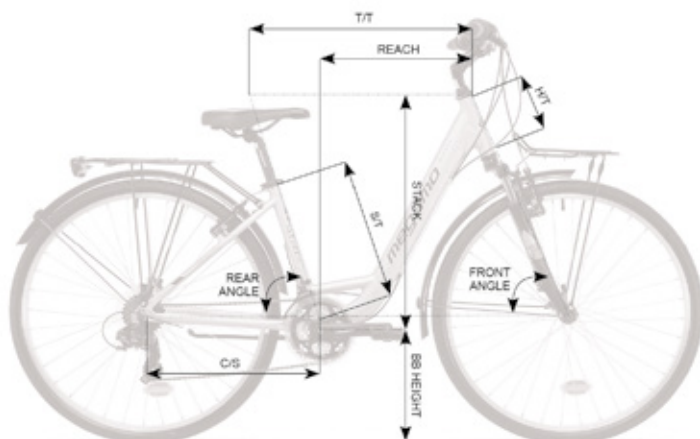

TACAMA





28"

	S	M
SIZE	16"	18"
T/T	551	555
C/S	460	460
S/T	406	457
H/T	160	160
FRONT ANGLE	70°	70°
REAR ANGLE	73°	73°



SPECIFICATIONS / ESPECIFICACIONES

-  TREKKING ALLOY 6061
-  TREKKING SUSPENSION 80mm
-  CH-9080 OVERSIZE
-  TREKKING 620mm
-  ALLOY 235 REGULABLE 25.4x150x90mm
-  ALLOY 27.2x350mm
-  MEGAMO TREKKING
-  SHIMANO TX35
-  SHIMANO TZ30
-  PROWHEEL 920 ALLOY 42-32-22T
-  SHIMANO RS35

-  V-BRAKE ALLOY
-  FORMULA ALLOY FM21 FM31 36H
-  ALLOY SCOUT
-  TREKKING 1.75
-  SHIMANO TZ21 7s 14-28 T

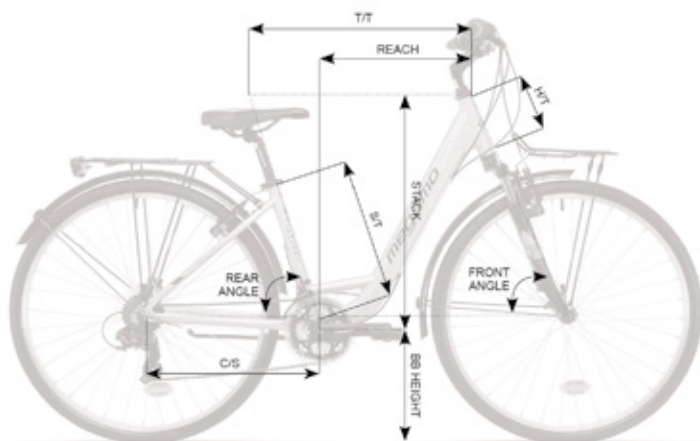

KIBO	26"
	onesize
SIZE	15"
T/T	542
C/S	425
S/T	381
H/T	160
FRONT ANGLE	70°
REAR ANGLE	72,7°





CITY

URBAN

AERO FIXIE	252
NONAME PRO ORANGE / BLACK.....	253
NONAME GREEN / COOPER / SILVER / BLUE.....	254-255
28 AMSTERDAM	256-257

CITY

28 TAMARIU GREEN / WHITE.....	258
28 TRIVIA DARK BLUE / BEIGE.....	259
26 TRIVIA COOPER / BLUE.....	260
24 TRIVIA.....	261
28 RONDA	262
26 RONDA WHITE / BLACK.....	263

FOLDING

24 MAXI	264
20 ZAMBRA GREY / WHITE	265

AERO FIXIE



SPECIFICATIONS / ESPECIFICACIONES

 ALLOY 6061 FIXIE FRAME

 ALLOY 6061 AERO FORK FOR FIXIE

 FIXIE CRANK 46T*170

 CALIPER ALLOY

 700c 32H h:40mm ANODIZED BLACK

 FIXIE 28" 622x28C

 MONO 18T + FIXED 18T

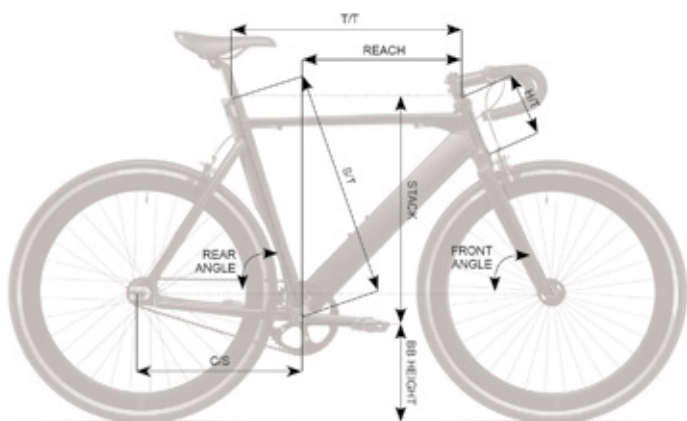

AERO FIXIE

	54	58
SIZE	54	58
T/T	544	580
C/S	408	408
S/T	540	580
H/T	120	150
REACH	-	-
STACK	-	-
BB HEIGHT	-	-
FRONT ANGLE	71	71
REAR ANGLE	73	73

NONAME PRO ORANGE / BLACK

NONAME PRO
ORANGE



NONAME PRO
BLACK



SPECIFICATIONS / ESPECIFICACIONES

-  ALLOY 6061 FIXIE FRAME
-  ALLOY 6061 AERO FORK FOR FIXIE
-  FIXIE CRANK 46T*170

-  CALIPER ALLOY
-  700c 32H h:40mm ANODIZED BLACK
-  FIXIE 28" 622x28C
-  MONO 18T + FIXED 18T

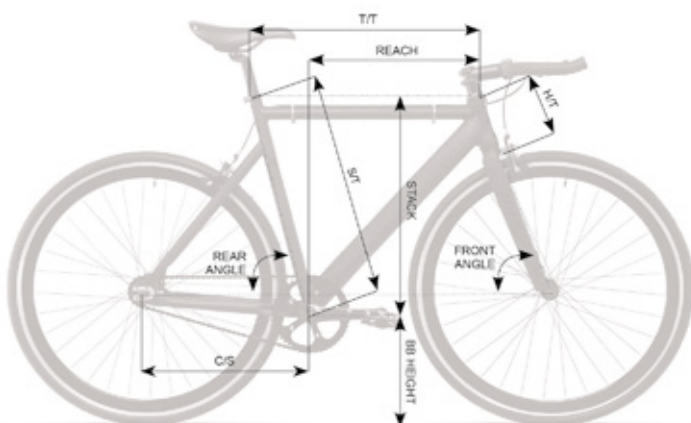

NONAME PRO

	55	59
SIZE	55	59
T/T	538	577
C/S	402	402
S/T	550	590
H/T	110	150
REACH	407	437
STACK	516	554
BB HEIGHT	289	289
FRONT ANGLE	74°	74°
REAR ANGLE	76°	76°

NONAME GREEN/COOPER

**NONAME
GREEN**



**NONAME
COOPER**



SPECIFICATIONS / ESPECIFICACIONES

 FIXIE HI-TEN 28"

 HI-TEN UNICROWN

 FIXIE 46T x 170mm

 FIXIE ALLOY

 ALLOY EVO DOUBLE WALL

 FIXIE 28" 622x28C

 MONO 18T + FIXED 18T

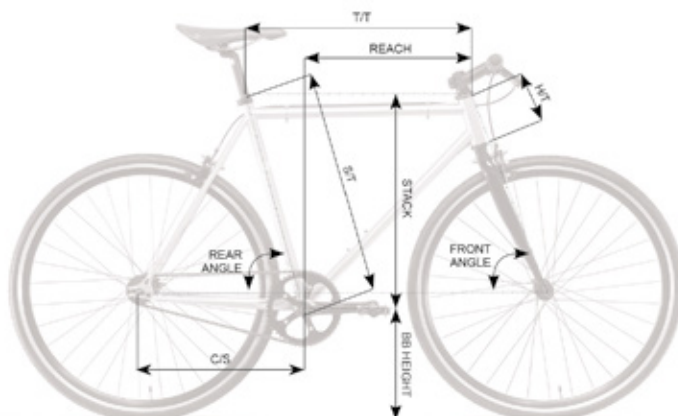

NONAME

	55	59
SIZE	55	59
T/T	545	580
C/S	405	402
S/T	545	590
H/T	120	150
REACH	407	437
STACK	516	554
BB HEIGHT	289	289
FRONT ANGLE	72°	74°
REAR ANGLE	75°	76°

NONAME SILVER/BLUE



**NONAME
SILVER**



**NONAME
BLUE**



SPECIFICATIONS / ESPECIFICACIONES

-  FIXIE HI-TEN 28"
-  HI-TEN UNICROWN
-  FIXIE 46T x 170mm

-  FIXIE ALLOY
-  ALLOY EVO DOUBLE WALL
-  FIXIE 28" 622x28C
-  MONO 18T + FIXED 18T

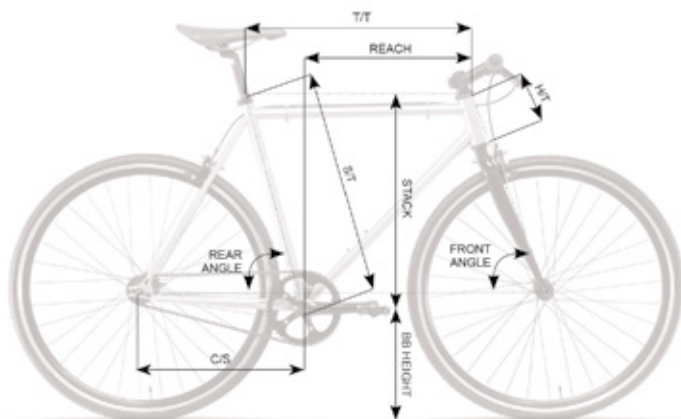

NONAME

	55	59
SIZE	55	59
T/T	545	580
C/S	405	402
S/T	545	590
H/T	120	150
REACH	407	437
STACK	516	554
BB HEIGHT	289	289
FRONT ANGLE	72°	74°
REAR ANGLE	75°	76°

28 AMSTERDAM



SPECIFICATIONS / ESPECIFICACIONES

	CITY HI-TEN 28"
	HI-TEN UNICROWN
	SHIMANO TZ50 6s
	SINGLE SPEED 38x170mm
	SHIMANO REVOSHIFT RS36 6s

	ALLOY V-BRAKE
	ALLOY 28"
	CITY 28x1.75
	SHIMANO TZ20 6s

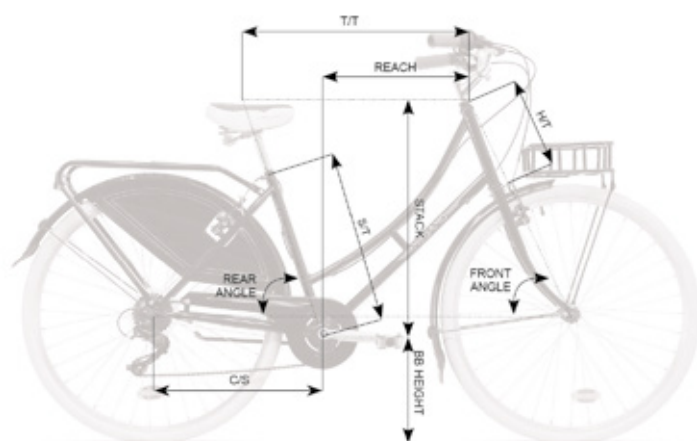

28 AMSTERDAM

	one size
SIZE	-
T/T	575
C/S	460
S/T	460
H/T	210
REACH	-
STACK	-
BB HEIGHT	-
FRONT ANGLE	71
REAR ANGLE	71



WEAR/ROPA

KIDS BMX

CITY

TREKKING

FAT

ROAD

MTB

E-BIKES

28 TAMARIU GREY / WHITE

**28 TAMARIU
GREY**



**28 TAMARIU
WHITE**



SPECIFICATIONS / ESPECIFICACIONES

-  CITY ALLOY 6061 28"
-  HI-TEN UNICROWN
-  SHIMANO TZ50 6v
-  SINGLE SPEED 38 x 170mm

-  SHIMANO REVOSHIFT RS35 6v
-  ALLOY V-BRAKE
-  ALLOY 28"
-  CITY 1.50
-  SHIMANO TZ20 6v

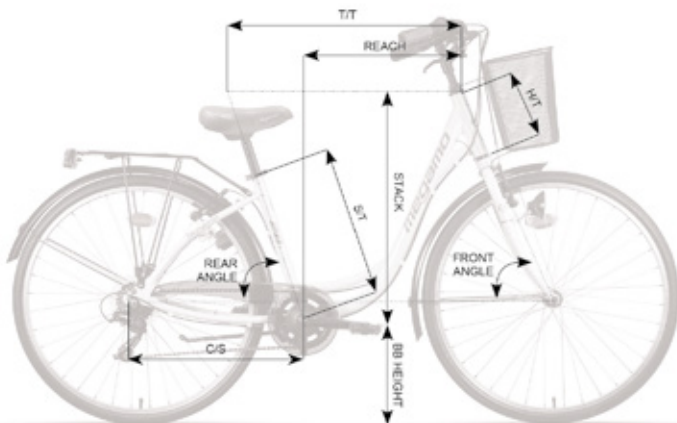

28 TAMARIU	28"
SIZE	onesize
T/T	16,5"
C/S	581
S/T	455
H/T	420
FRONT ANGLE	170
REAR ANGLE	70°
	72,7°

28 TRIVIA DARK BLUE / BEIGE

28 TRIVIA
DARK BLUE



28 TRIVIA
BEIGE



SPECIFICATIONS / ESPECIFICACIONES

-  CITY HI-TEN 28"
-  HI-TEN UNICROWN
-  SHIMANO TZ50 6s
-  SINGLE SPEED 38x170mm

- SHIMANO REVOSHIFT RS36 6s
- ALLOY V-BRAKE
- ALLOY 28"
-  CITY 28x1.75
- SHIMANO TZ20 6s

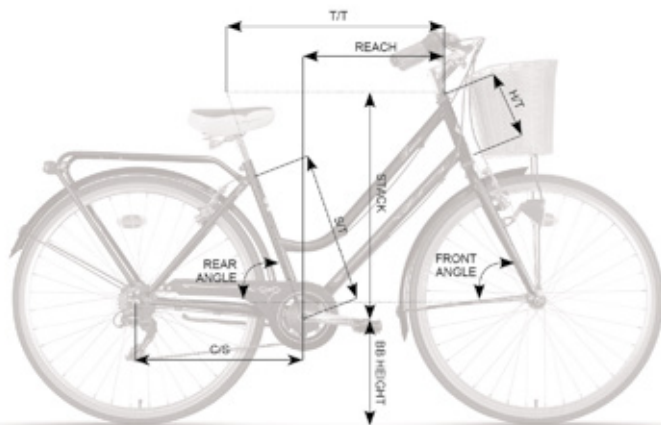

28 TRIVIA 28"

	onesize
SIZE	18"
T/T	602
C/S	450
S/T	460
H/T	180
REACH	396
STACK	593
BB HEIGHT	305
FRONT ANGLE	70,8°
REAR ANGLE	70,7°

26 TRIVIA COOPER / BLUE

**26 TRIVIA
COOPER**



**26 TRIVIA
BLUE**



SPECIFICATIONS / ESPECIFICACIONES

 CITY HI-TEN 26"

 HI-TEN UNICROWN

 SHIMANO TZ50 6s

 SINGLE SPEED 38x170mm

 SHIMANO REVOSHIFT RS36 6s

 ALLOY V-BRAKE

 ALLOY 26"

 CITY 26x1.75

 SHIMANO TZ20 6s

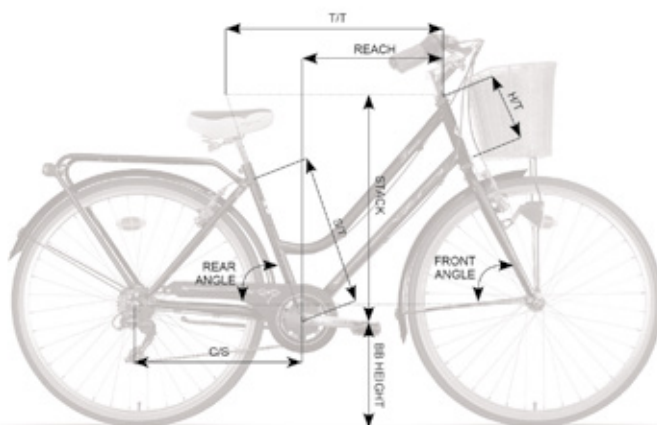







26 TRIVIA 26"

	onesize
SIZE	16,5"
T/T	596
C/S	440
S/T	420
H/T	170
REACH	388
STACK	569
BB HEIGHT	274
FRONT ANGLE	70°
REAR ANGLE	70°



SPECIFICATIONS / ESPECIFICACIONES

	CITY HI-TEN 24"
	HI-TEN UNICROWN
	CH-80
	CITY STEEL
	CITY ALLOY 22.2x150x80mm
	ALLOY 25 x 330mm
	MEGAMO CONFORT
	SHIMANO TY21 6s
	SINGLE SPEED 38x170mm
	SHIMANO REVOSHIFT RS36 6s

	ALLOY V-BRAKE
	UNION 36H
	ALLOY 24"
	CITY 24x1.75
	SHIMANO TZ21 6s

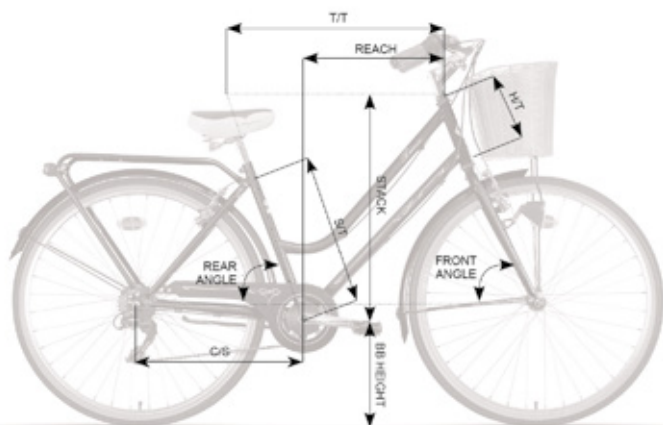

24 TRIVIA















24"

	onesize
SIZE	15"
T/T	524
C/S	410
S/T	380
H/T	160
REACH	343
STACK	519
BB HEIGHT	270
FRONT ANGLE	70,7°
REAR ANGLE	70,7°

28 RONDA



SPECIFICATIONS / ESPECIFICACIONES

 CITY HI-TEN 28"	 ALLOY V-BRAKE
 HI-TEN UNICROWN	 UNION 36H
 CH-80	 ALLOY 28"
 CITY STEEL	 CITY 28x1.50
 CITY ALLOY 22.2x150x80mm	 SHIMANO TZ30 14-34T 6s
 STEEL 25x330mm	
 MEGAMO CONFORT	
 SHIMANO TZ50 6s	
 SINGLE SPEED 38x170mm	
 SHIMANO REVOSHIFT RS35 6s	

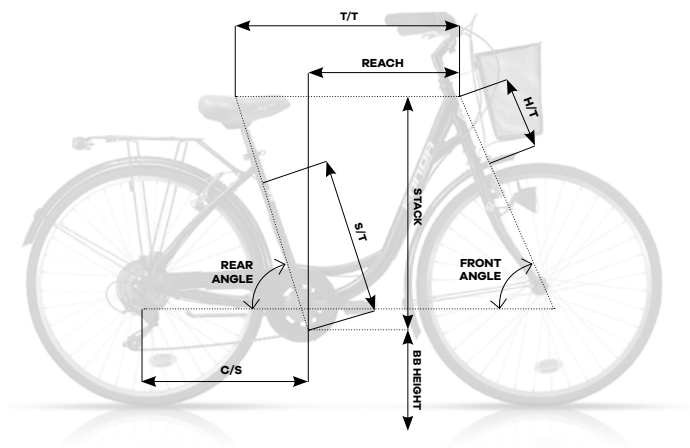

28 RONDA		28"
		onesize
SIZE		18"
T/T		570
C/S		450
S/T		460
H/T		180
FRONT ANGLE		70,8°
REAR ANGLE		70,7°

26 RONDA WHITE / BLACK

26 RONDA
WHITE







26 RONDA
BLACK



SPECIFICATIONS / ESPECIFICACIONES

-  CITY HI-TEN 26"
-  HI-TEN UNICROWN
-  SHIMANO TZ50 6s
-  SINGLE SPEED 38x170mm

-  SHIMANO REVOSHIFT RS35 6s
-  ALLOY V-BRAKE
-  ALLOY 26"
-  CITY 26x1.75
-  SHIMANO TZ20 6s

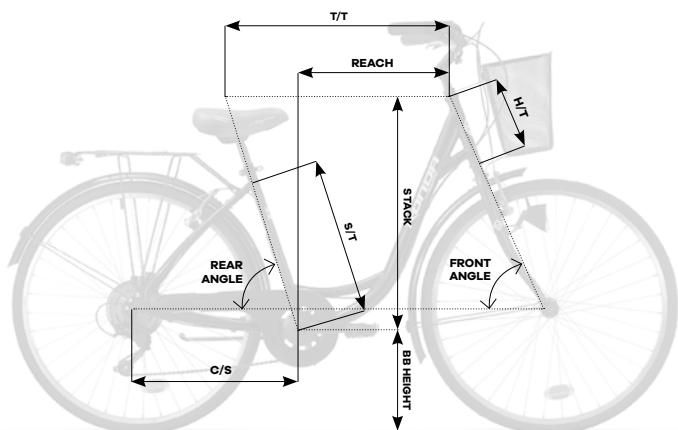



26 RONDA	26"
SIZE	onesize
T/T	540
C/S	440
S/T	420
H/T	170
FRONT ANGLE	70°
REAR ANGLE	72,7°

24 MAXI



SPECIFICATIONS / ESPECIFICACIONES

 FOLDING ALLOY 6061

 HI-TEN UNICROWN

 AHEAD 281

 ALLOY WITH RISE

 ALLOY FOLDING REGULABLE

 MEGAMO 31.8 x 550 mm

 MEGAMO CONFORT

 SHIMANO TY21 6s

 ALLOY 48 x 170mm

 SHIMANO REVOSHIFT RS35

 V-BRAKE ALLOY

 UNION 36H

 ALLOY SCOUT BLACK

 CITY 1.75

 SHIMANO MF-TZ20 6s

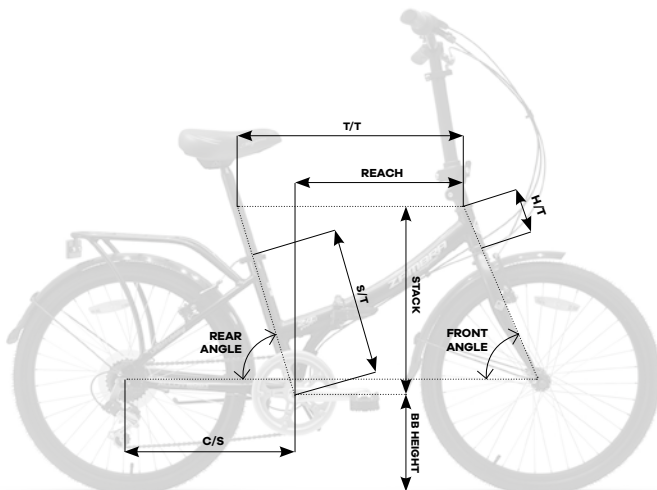

24 MAXI

24"

	onesize
SIZE	14"
T/T	568
C/S	420
S/T	355
H/T	90
REACH	421
STACK	450
BB HEIGHT	285
FRONT ANGLE	71°
REAR ANGLE	72°

20 ZAMBRA GREY / WHITE

E-BIKES

MTB

ROAD

FAT

TREKKING

CITY

KIDS BMX

WEAR/ROPA

**20 ZAMBRA
GREY**



**20 ZAMBRA
WHITE**



SPECIFICATIONS / ESPECIFICACIONES

FOLDING ALLOY 6061

HI-TEN UNICROWN

SHIMANO TY21 6s

ALLOY 48 x 170mm

SHIMANO REVOSHIFT RS35

V-BRAKE ALLOY

ALLOY SCOUT BLACK

CITY 1.75

SHIMANO MF-TZ20 6s

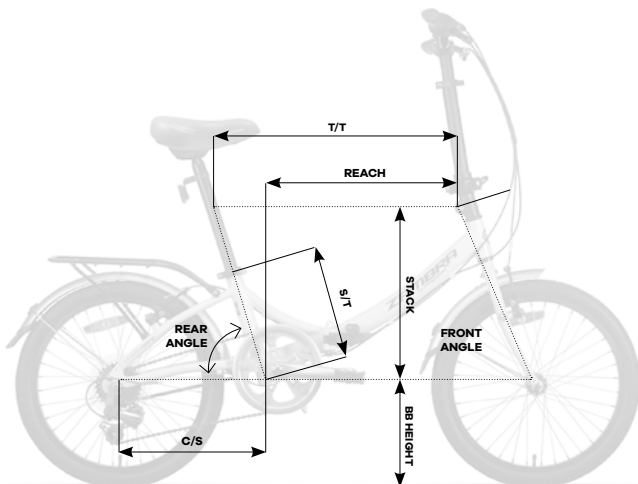

20 ZAMBRA 20"

SIZE	onesize
SIZE	10"
T/T	607
C/S	380
S/T	258
H/T	90
REACH	462
STACK	344
BB HEIGHT	300
FRONT ANGLE	73°
REAR ANGLE	73°





megamo

KIDS / BMX

KIDS

20 OPEN JUNIOR SUSP. BOY	268
20 OPEN JUNIOR SUSP. GIRL	269
20 OPEN JUNIOR BOY <i>YELLOW / BLUE</i>	270
20 OPEN JUNIOR GIRL <i>BLUE / WHITE</i>	271
18 KID BOY / GIRL	272
16 KID BOY / GIRL	273
14 KID BOY / GIRL	274-275















BMX

BLAZER <i>GREEN / ORANGE</i>	276-277
------------------------------------	---------

20 OPEN JUNIOR SUSP. BOY



SPECIFICATIONS / ESPECIFICACIONES

 ALLOY 6061 HYDROFORMED	 ALLOY KIDS
 ALLOY 386 80mm	 UNION 36H
 AHEAD CH-281	 ALLOY SCOUT BLACK
 MEGAMO W: 560mm	 MTB 1.95
 AHEAD 90mm	 SHIMANO MF TZ21 6s
 ALLOY 27.2 x 300mm	
 MEGAMO	
 SHIMANO TZ50 6s	
 PROWHEEL 114 38T	
 SHIMANO REVOSHIFT RS35	

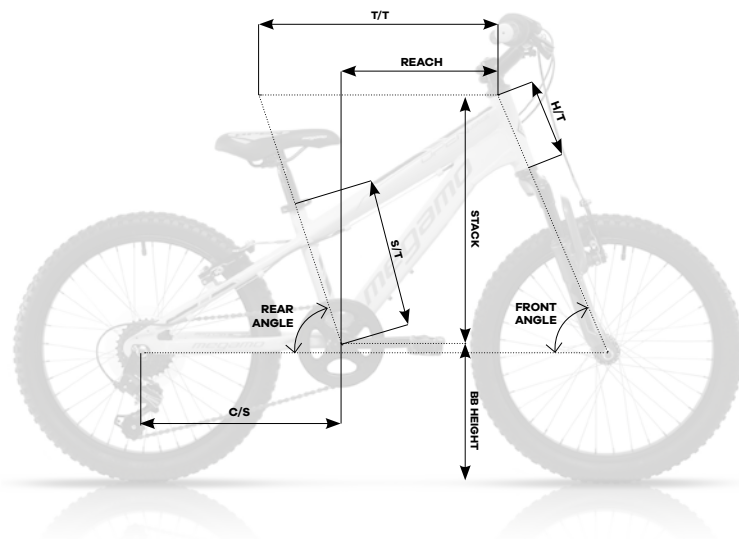

OPEN JUNIOR SUSP. BOY

20"

	onesize
SIZE	10,5"
T/T	432
C/S	355
S/T	270
H/T	145
FRONT ANGLE	71°
REAR ANGLE	72,8°

20 OPEN JUNIOR SUSP. GIRL

E-BIKES

MTB

ROAD

FAT

TREKKING











CITY

KIDS BMX

WEAR/ROPA



SPECIFICATIONS / ESPECIFICACIONES

-  ALLOY 6061 HYDROFORMED
-  ALLOY 386 80mm
-  AHEAD CH-281
-  MEGAMO W: 560mm
-  AHEAD 90mm
-  ALLOY 272 x 300mm
-  MEGAMO
-  SHIMANO TZ50 6s
-  PROWHEEL 114 38T
-  SHIMANO REVOSHIFT RS35

-  ALLOY KIDS
-  UNION 36H
-  ALLOY SCOUT BLACK
-  MTB 1.95
-  SHIMANO MF TZ21 6s

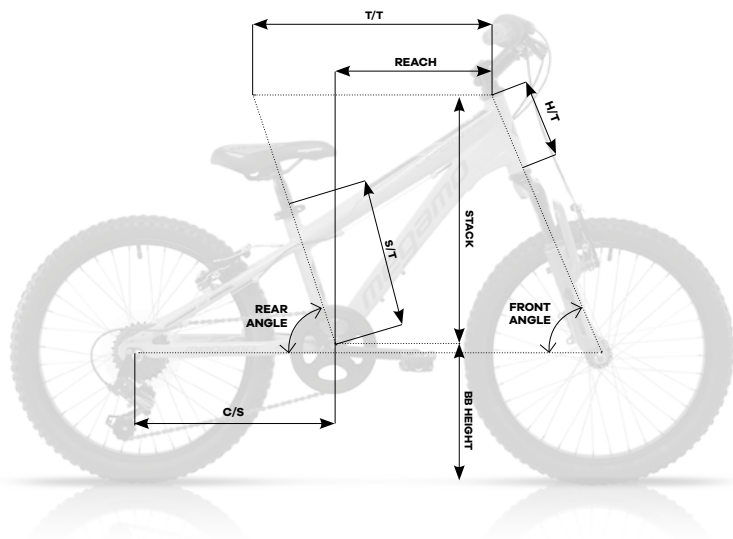

OPEN JUNIOR SUSP. GIRL

20"

SIZE	onesize
T/T	432
C/S	355
S/T	270
H/T	145
FRONT ANGLE	71°
REAR ANGLE	72,8°

20 OPEN JUNIOR BOY YELLOW / BLUE

**20 OPEN JUNIOR BOY
YELLOW**



**20 OPEN JUNIOR BOY
BLUE**



SPECIFICATIONS / ESPECIFICACIONES

-  HI-TEN 20"
-  HI-TEN UNICROWN
-  SHIMANO TZ50 6s
-  SINGLE SPEED 36T

-  SHIMANO REVOSHIFT RS35
-  ALLOY KIDS
-  ALLOY SILVER
-  MTB 1.95
-  SHIMANO MF TZ21 6s

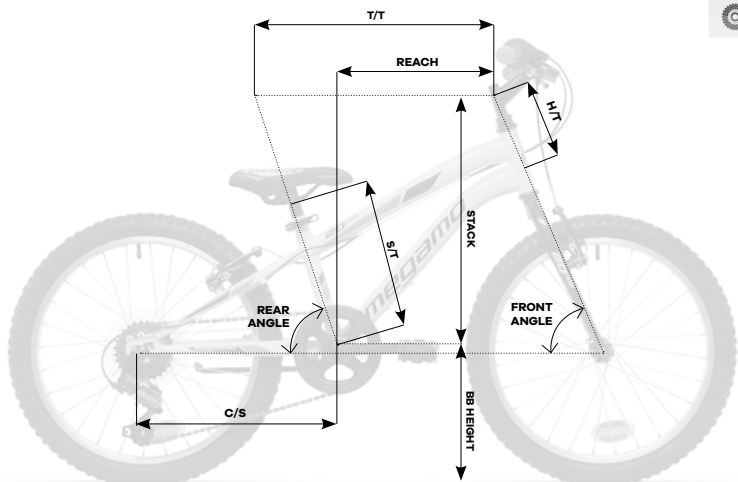

OPEN JUNIOR BOY 20"

	onesize
SIZE	11"
T/T	421
C/S	355
S/T	280
H/T	120
FRONT ANGLE	72°
REAR ANGLE	72°

20 OPEN JUNIOR GIRL BLUE / WHITE

E-BIKES

MTB

ROAD

FAT

TREKKING

CITY

KIDS BMX

WEAR/ROPA

**20 OPEN JUNIOR GIRL
BLUE**







**20 OPEN JUNIOR GIRL
WHITE**



SPECIFICATIONS / ESPECIFICACIONES

-  HI-TEN 20"
-  HI-TEN UNICROWN
-  SHIMANO TZ50 6s
-  SINGLE SPEED 36T

-  SHIMANO REVOSHIFT RS35
-  ALLOY KIDS
-  ALLOY SILVER
-  MTB 1.95
-  SHIMANO MF TZ21 6s

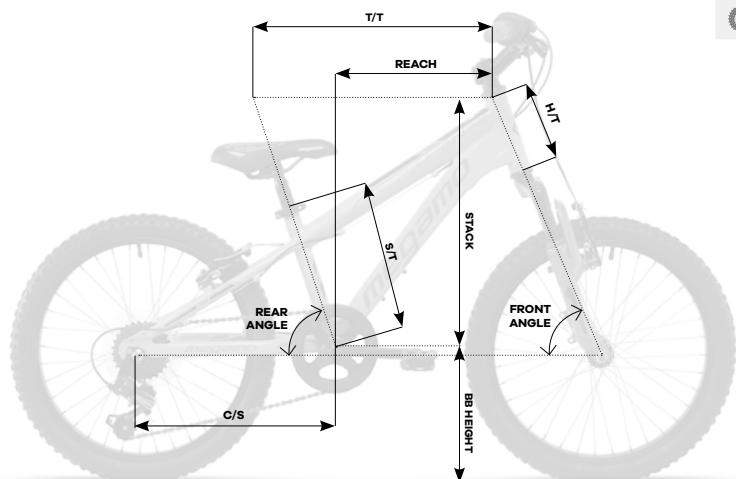

OPEN JUNIOR GIRL 20"

	onesize
SIZE	11"
T/T	421
C/S	355
S/T	280
H/T	120
FRONT ANGLE	72°
REAR ANGLE	72°

18 KID BOY / GIRL

18 KID BOY





18 KID GIRL



SPECIFICATIONS / ESPECIFICACIONES

-  HI-TEN 18"
-  HI-TEN UNICROWN
-  SINGLE SPEED
-  SINGLE 36T x 127mm

-  ALLOY KIDS
-  ALLOY SILVER
-  MTB 1.95
-  SINGLE SPEED 18T

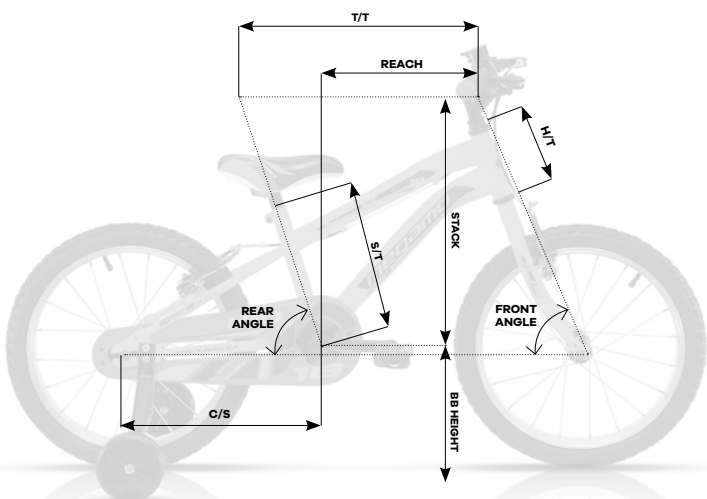

KID BOY/GIRL 18"

	onesize
SIZE	9,5"
T/T	383
C/S	330
S/T	240
H/T	120
FRONT ANGLE	71°
REAR ANGLE	75,8°

16 KID BOY / GIRL

E-BIKES

MTB

ROAD

FAT

TREKKING

CITY

KIDS BMX

WEAR/ROPA

16 KID BOY



16 KID GIRL



SPECIFICATIONS / ESPECIFICACIONES

-  HI-TEN 16"
-  HI-TEN UNICROWN
-  SINGLE SPEED
-  SINGLE 31T x 114mm

-  ALLOY KIDS
-  ALLOY SILVER
-  MTB 1.75
-  SINGLE SPEED 16T

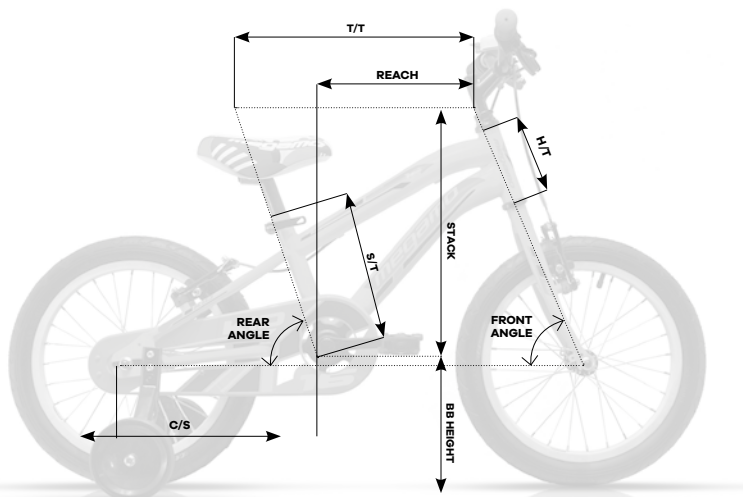

KID BOY/GIRL 16"

	onesize
SIZE	8,5"
T/T	360
C/S	305
S/T	220
H/T	120
FRONT ANGLE	71°
REAR ANGLE	75°

14 KID BOY / GIRL

14 KID BOY



14 KID GIRL



SPECIFICATIONS / ESPECIFICACIONES

-  HI-TEN 14"
-  HI-TEN UNICROWN
-  SINGLE SPEED
-  SINGLE 31T x 114mm

-  ALLOY KIDS
-  ALLOY SILVER
-  MTB 1.75
-  SINGLE SPEED 16T

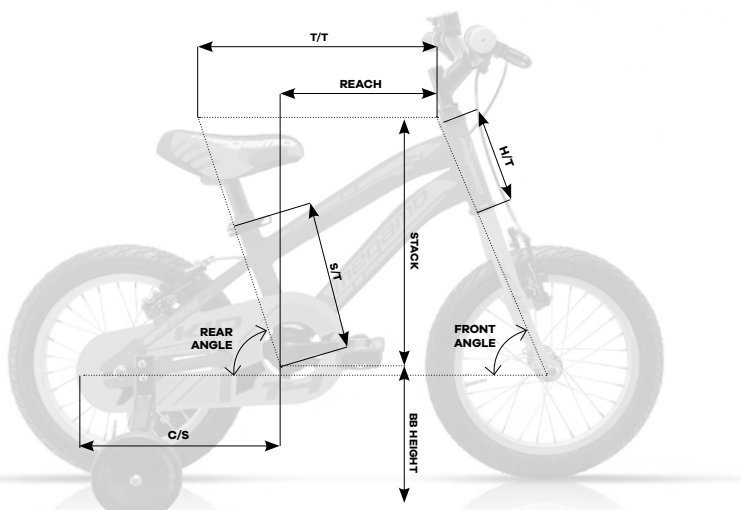

KID BOY/GIRL 14"

	onesize
SIZE	8"
T/T	325
C/S	240
S/T	200
H/T	120
FRONT ANGLE	70°
REAR ANGLE	71°



WEAR/ROPA

KIDS BMX

CITY

TREKKING

FAT

ROAD

MTB

E-BIKES

BLAZER GREEN



SPECIFICATIONS / ESPECIFICACIONES

 BMX HI-TEN

 BMX HI-TEN

 33T 165mm

 V-BRAKE ALLOY

 BMX SILVER

 BMX 2.0

 BMX 16T

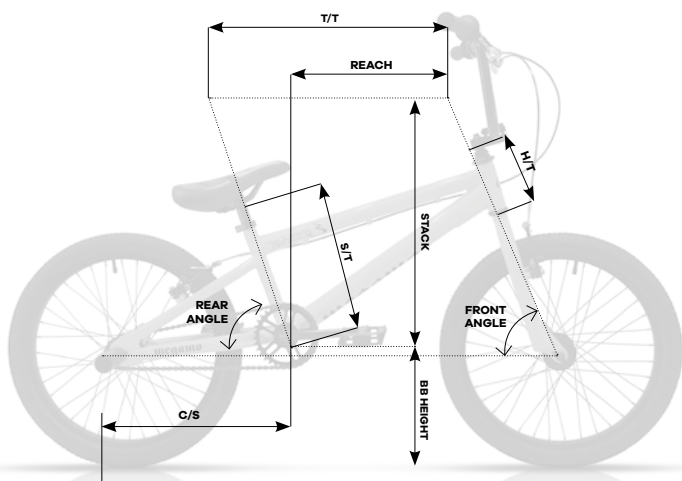



BLAZER

	onesize
SIZE	10"
T/T	515
C/S	352
S/T	250
H/T	100
FRONT ANGLE	73,5°
REAR ANGLE	78,1°



SPECIFICATIONS / ESPECIFICACIONES

 BMX HI-TEN
 BMX HI-TEN
 33T 165mm

 V-BRAKE ALLOY
 BMX SILVER
 BMX 2.0
 BMX 16T

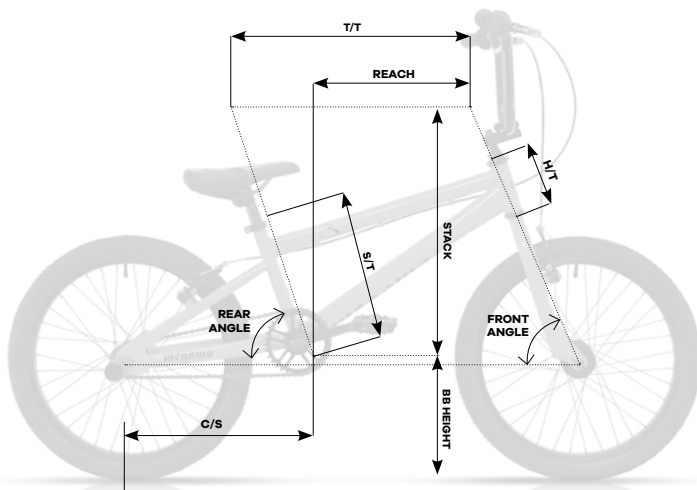

BLAZER

SIZE	onesize
T/T	515
C/S	352
S/T	250
H/T	100
FRONT ANGLE	73,5°
REAR ANGLE	78,1°





megamo

WEAR/ROPA

<i>MAILLOT ORANGE</i>	280
<i>CULOTTE ORANGE</i>	281
<i>MAILLOT GREEN</i>	282
<i>CULOTTE GREEN</i>	283
<i>ACCESSORIES</i>	284

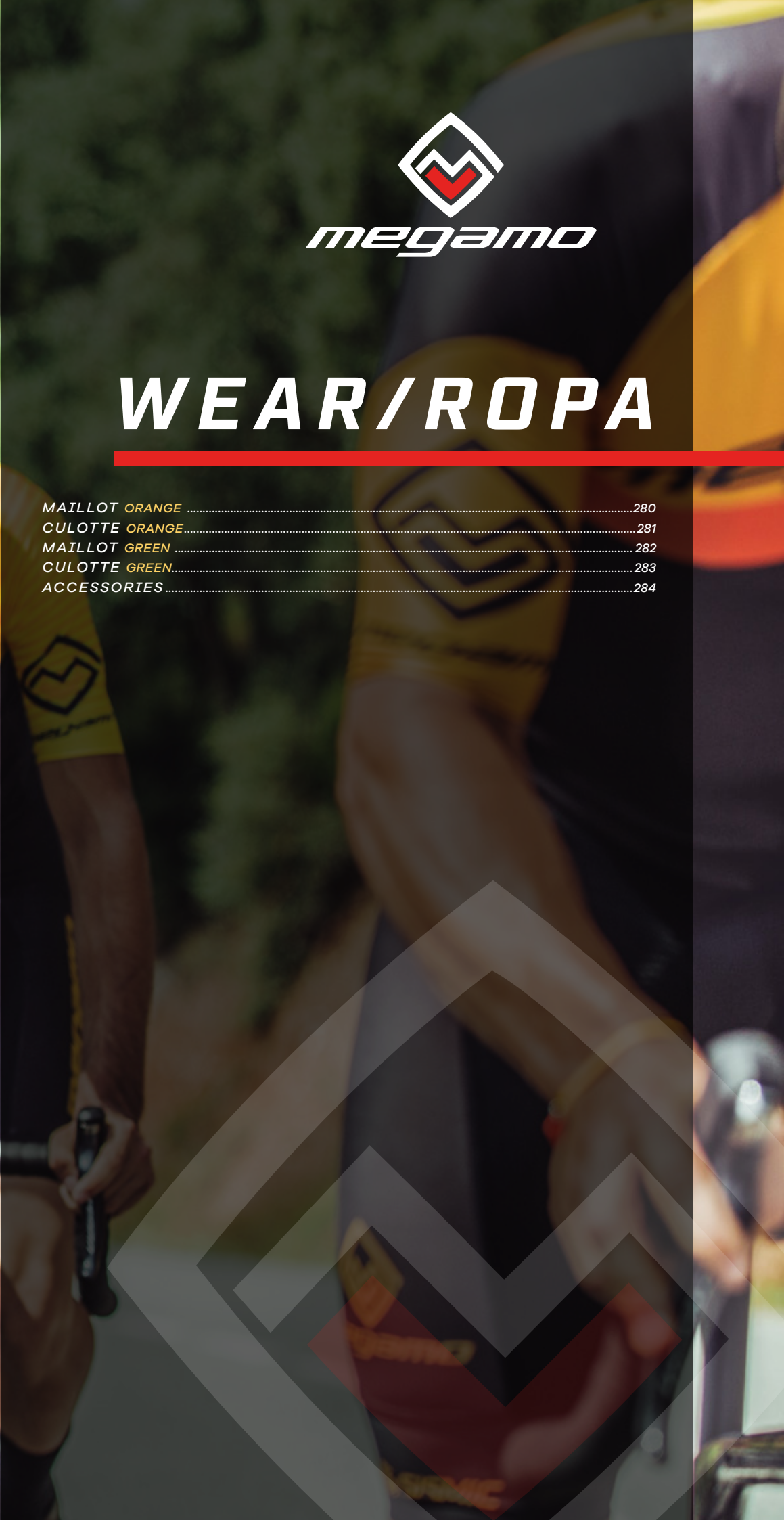



LIGHTNESS AND BREATHABILITY FIRST.

A jersey that stands out for its lightness and breathability. A high performance garment that will adapt perfectly to your body thanks to the great elasticity of the 3 lycras that compose it. Fitted sleeves, low neck and non-slip silicone rubber at the waist for a streamlined and comfortable position.

The Skin jersey is a model designed to suit anyone who makes frequent use of the bike and wants to enjoy a comfortable and high performance garment.

LIGEREZA Y TRANSPIRABILIDAD ANTE TODO.

Un maillot que destaca por su ligereza y transpirabilidad. Una prenda de altas prestaciones que se adaptará perfectamente a tu cuerpo gracias a la gran elasticidad de las 3 lycras que lo componen. Mangas ajustadas, cuello bajo y goma siliconada antideslizante en la cintura para buscar una posición aerodinámica y de confort.

El maillot Skin es un modelo pensado para adaptarse a todo aquel que haga un uso frecuente de la bicicleta y quiera disfrutar de una prenda confortable y de altas prestaciones.

CULOTTE ORANGE



FOR THOSE WHO WANT TO ENJOY CYCLING IN THEIR CYCLING OUTINGS.

Low grip with lycra rubber.

Ergonomically shaped, highly breathable and elastic micro-strap straps for added fit and comfort.

Lycra® made of high performance fabric, capable of ensuring correct compression of the muscle improving performance.

PARA LOS QUE QUIEREN DISFRUTAR DEL CICLISMO EN SUS SALIDAS.

Agarre bajo con goma con lycra.

Tirantes de microrejilla altamente transpirables y elásticos en forma ergonómica para mayor ajustabilidad y confort.

Lycra® compuesta por tejido de alto rendimiento, capaz de asegurar la compresión correcta del músculo mejorando su rendimiento.



LIGHTNESS AND BREATHABILITY FIRST.

A jersey that stands out for its lightness and breathability. A high performance garment that will adapt perfectly to your body thanks to the great elasticity of the 3 lycras that compose it. Fitted sleeves, low neck and non-slip silicone rubber at the waist for a streamlined and comfortable position.

The Skin jersey is a model designed to suit anyone who makes frequent use of the bike and wants to enjoy a comfortable and high performance garment.

LIGEREZA Y TRANSPIRABILIDAD ANTE TODO.

Un maillot que destaca por su ligereza y transpirabilidad. Una prenda de altas prestaciones que se adaptará perfectamente a tu cuerpo gracias a la gran elasticidad de las 3 lycras que lo componen. Mangas ajustadas, cuello bajo y goma siliconada antideslizante en la cintura para buscar una posición aerodinámica y de confort.

El maillot Skin es un modelo pensado para adaptarse a todo aquel que haga un uso frecuente de la bicicleta y quiera disfrutar de una prenda confortable y de altas prestaciones.



FOR THOSE WHO WANT TO ENJOY CYCLING IN THEIR CYCLING OUTINGS.

Low grip with lycra rubber.

Ergonomically shaped, highly breathable and elastic micro-strap straps for added fit and comfort.

Lycra® made of high performance fabric, capable of ensuring correct compression of the muscle improving performance.

PARA LOS QUE QUIEREN DISFRUTAR DEL CICLISMO EN SUS SALIDAS.

Agarre bajo con goma con lycra.

Tirantes de microrejilla altamente transpirables y elásticos en forma ergonómica para mayor ajustabilidad y confort.

Lycra® compuesta por tejido de alto rendimiento, capaz de asegurar la compresión correcta del músculo mejorando su rendimiento.

CAP

























MEN T-SHIRT



WOMEN T-SHIRT



Frame		Cuadro
Fork		Horquilla
Rear shock		Amortiguador
Headset		Dirección
Handlebar		Manillar
Stem		Potencia
Seat post		Tija sillín
Saddle		Sillín
Rear derailleur		Cambio
Front derailleur		Desviador
Chainwheel		Bielas
Shift lever		Manetas cambio
Brake lever		Manetas freno
Hubs		Carretes
Wheels		Ruedas
Tires		Neumáticos
Cassette		Piñones
Motor / e-drive system		Motor
Battery		Batería
Autonomy-range		Autonomía
Charging		Tiempo carga
Speed		Velocidad
Display		Display

Technical specifications subject may change without further notice. Pictures shown may not correspond with the technical specifications.

Las especificaciones técnicas pueden estar sujetas a cambios sin previo aviso. Las imágenes pueden no corresponder exactamente con las especificaciones técnicas.



Mosquerola, 61-63
17180 VILABLAREIX (Girona) Spain
Tel. (+34) 972 239 900
megamo@megamo.com



megamo

2019 COLLECTION

megamo.com